



ScanPal™ EDA51

powered by Android™

Quick Start Guide

Out of the Box

Make sure that your shipping box contains these items:

- ScanPal EDA51 mobile computer (Model EDA51-0 or EDA51-1)
- Rechargeable Li-ion battery (see [page 7](#))
- Hand strap (optional)
- Product documentation

If you ordered accessories for your mobile computer, verify that they are also included with the order. Be sure to keep the original packaging in case you need to return the mobile computer for service.

Note: *EDA51-0 models do not include a WWAN radio.*

Memory Card Specifications

Honeywell recommends the use of Single Level Cell (SLC) industrial grade microSD™ or microSDHC™ memory cards with ScanPal mobile computers for maximum performance and durability. Contact a Honeywell sales representative for additional information on qualified memory card options.

Mobile Computer Features

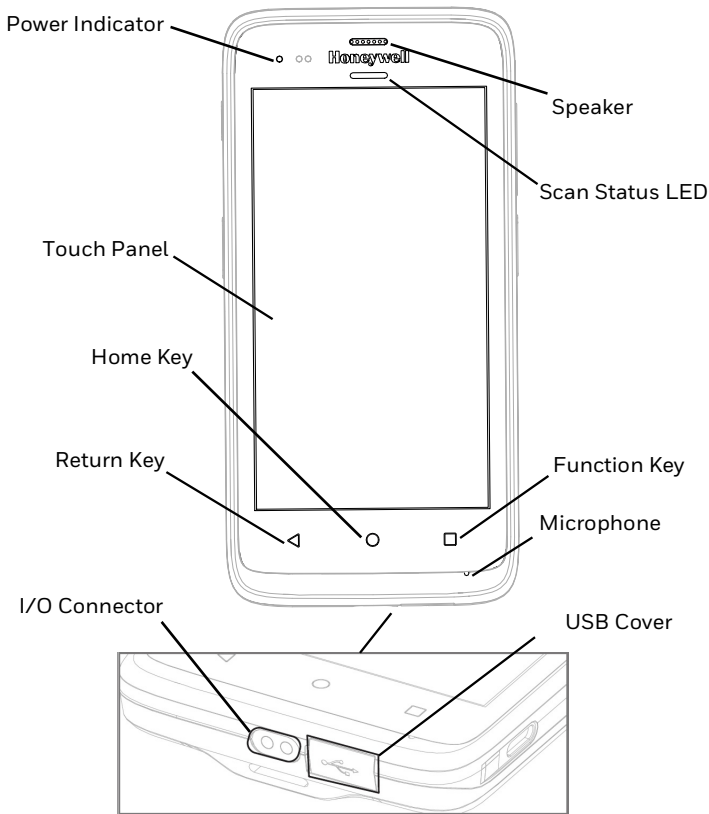

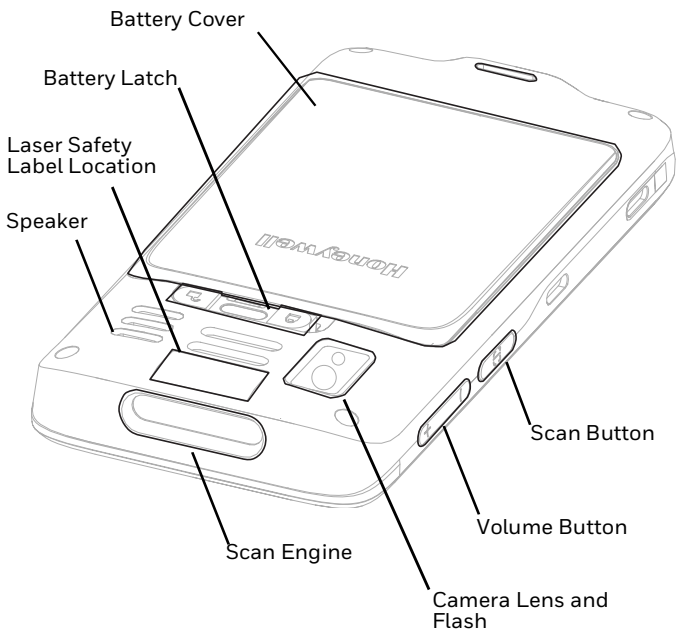

Remove the Battery Cover

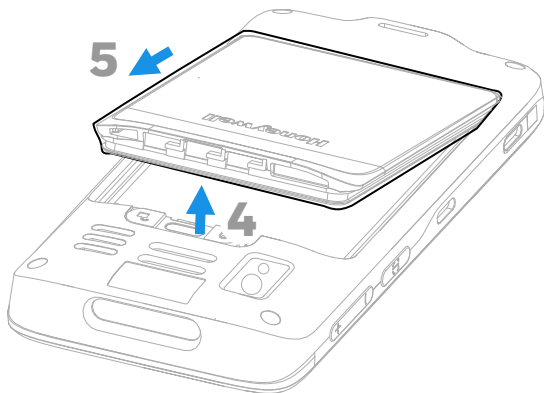
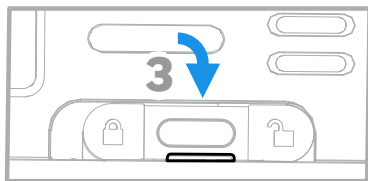
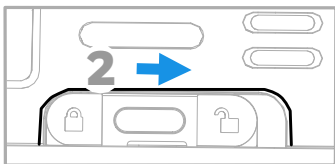
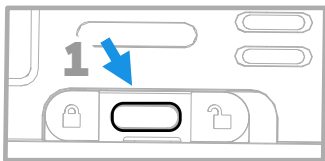

5

4

Install a Nano SIM Card

Only EDA51-1 (WWAN) models support Nano SIM card use for cellular phone feature.

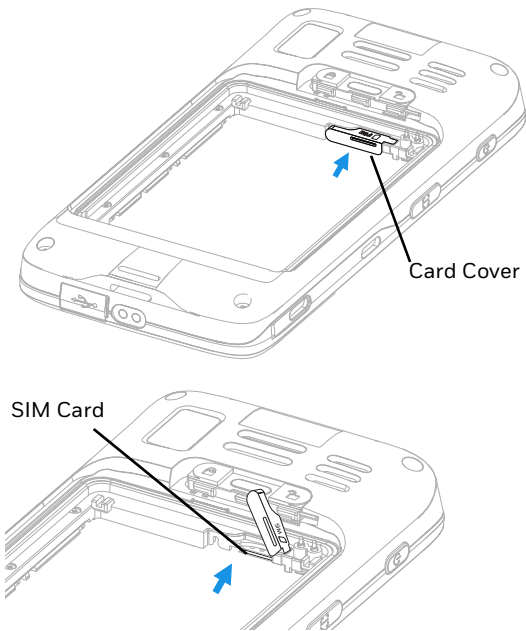

Note: Always power off the computer before attempting to install or remove a card.

Install a MicroSD Card (Optional)

Note: *Format the microSD card before initial use.*

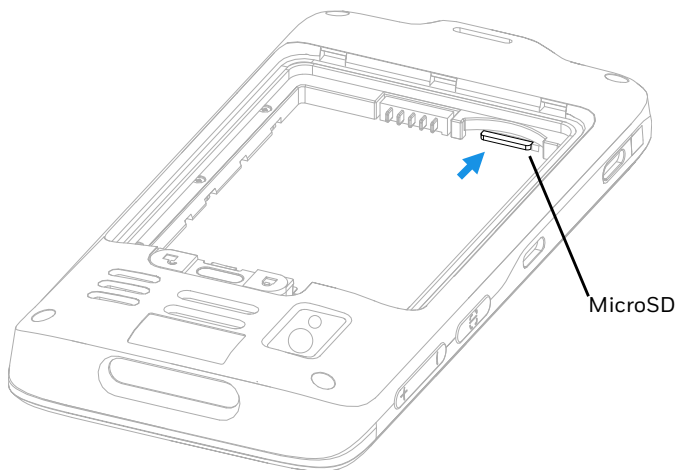

Note: *Always power off the computer before attempting to install or remove a card.*

About the Battery

The EDA51 mobile computer ships with a Li-ion battery manufactured for Honeywell International Inc.

Model Configuration	battery P/N	Power
EDA51-0	50129589-001, 50134176-001	3.8 VDC, 15.2 watt-hour
EDA51-1	50129589-001, 50134176-001	3.8 VDC, 15.2 watt-hour

Configuration number (CN) is located on the label in the battery well of the mobile computer.



We recommend use of Honeywell Li-ion battery packs. Use of any non-Honeywell battery may result in damage not covered by the warranty.



Ensure all components are dry prior to placing the battery in the computer. Mating wet components may cause damage not covered by the warranty.

Install the Battery

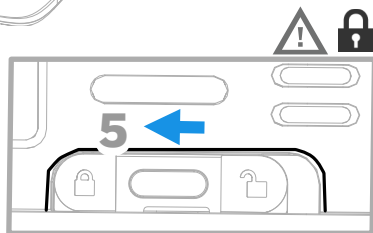
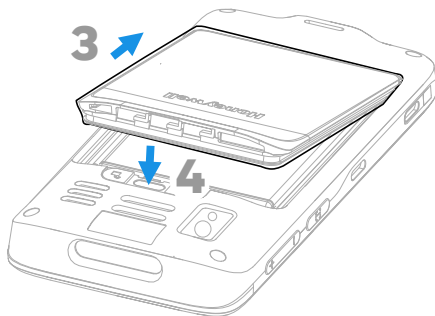
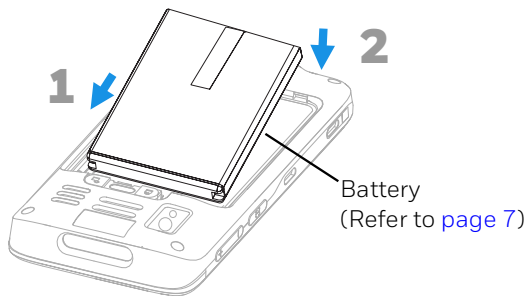

Install the Hand Strap (Optional)

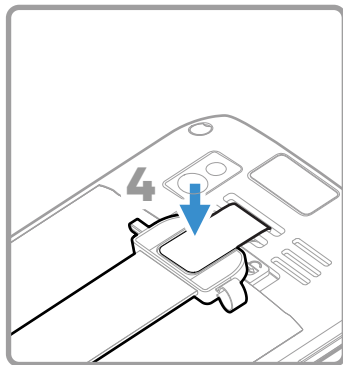
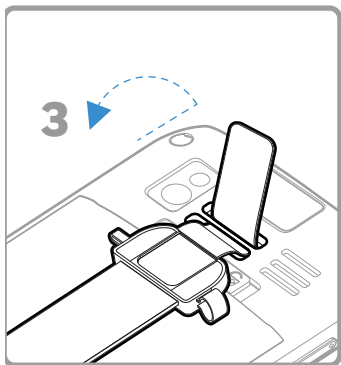
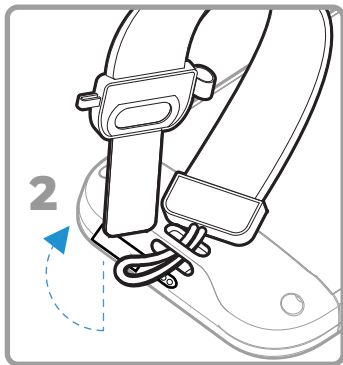
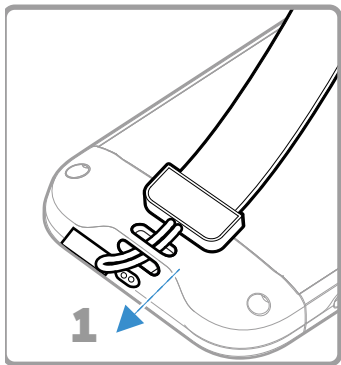

Charge the Mobile Computer

The EDA51 mobile computer ships with a partially charged battery. Charge the battery with a EDA51 Series charging device for a minimum of **4.5 hours**. Using the computer while charging the battery increases the time required to reach a full charge.



We recommend the use of Honeywell accessories and power adapters. Use of any non-Honeywell accessories or power adapters may cause damage not covered by the warranty.

EDA51 mobile computers are designed for use with the following EDA51 charging accessories: Single Charging Dock, Quad Bay Charge Base, Quad Battery Charger, and USB Cable. For more information about accessories, see the “ScanPal EDA51 Mobile Computer Accessories Guide” at www.honeywellaidc.com.



Ensure all components are dry prior to mating the computers and batteries with peripheral devices. Mating wet components may cause damage not covered by the warranty.

Turn Power On/Off

The first time you power on the computer, a Welcome screen appears. You can either scan a configuration bar code or use the Wizard to manually set up the computer. Once setup is complete, the Welcome screen no longer appears on startup and Provisioning mode is automatically turned off (disabled).

To turn the computer on:

- Press and hold the **Power** button for approximately 3 seconds, and then release.

To turn the computer off:

1. Press and hold the **Power** button until the options menu appears.
2. Touch **Power Off**.

Note: *You should always power off the computer before removing the battery.*

Sleep Mode

Sleep mode automatically turns the touch panel display off and locks the computer to save battery power when the computer is inactive for a programmed period of time.

1. Press and release the **Power** button to wake the computer.
2. Drag the  toward the top of the display to unlock the computer.

Adjust the Display Sleep Time

To adjust the amount of time before the display sleeps after inactivity:





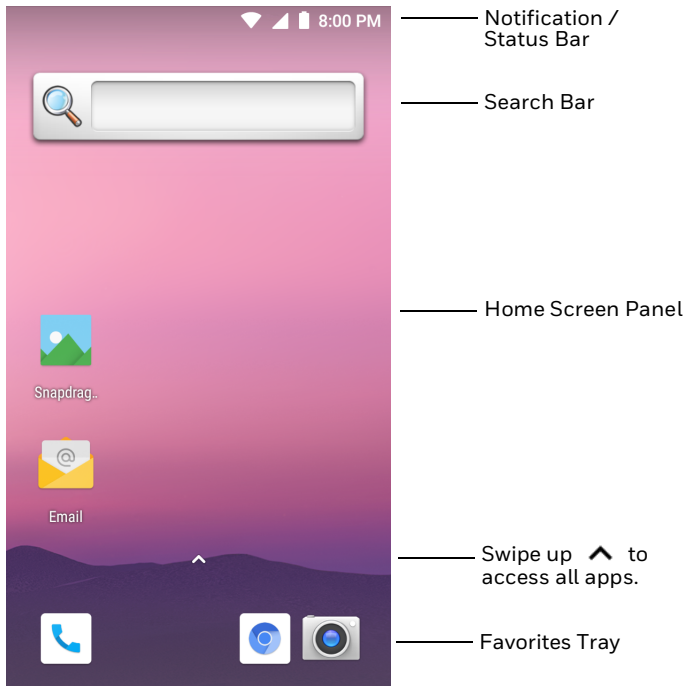

1. Swipe up on the touch screen.
2. Select **Settings > Display > Advanced > Sleep**.
3. Select the amount of time before the display goes to sleep.
4. Touch  to return to the Home screen.

About the Home Screen



To learn how to customize the Home screen, see the User Guide.

Navigation and Function Buttons

Button	Description	
	Back	Return to the previous screen.
	Home	Return to the Home screen.
	Recent Apps	View and switch between recently used apps.
	Volume	Press the top of the button to raise the speaker volume. Press the bottom of button to lower the speaker volume.
	Scan	Press left or right Scan button to trigger the scanner.
	Power button	See page 11 .

For button locations, see [Mobile Computer Features](#) on page 2.
To learn more about how to re-map a button, see the User Guide.

About Provisioning Mode

After completing the out-of-box set up process, Provisioning mode is automatically turned off. Scanning a bar code to install applications, certificates, configuration files, and licenses on the computer is restricted unless you enable Provisioning mode in the Settings app. To learn more, see the user guide.

Scan a Bar Code with the Scan Demo

For optimum performance, avoid reflections by scanning the bar code at a slight angle.

1. Swipe up on the screen.
2. Select **Demos > Scan Demo**.
3. Point the computer at the bar code.
4. Touch **Scan** on the screen or press and hold any Scan button. Center the aiming beam over the bar code.

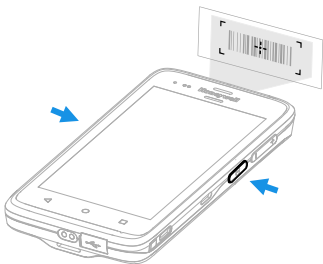

The decode results appear on the screen.

Note: *In the Scan Demo app, not all bar code symbologies are enabled by default. If a bar code does not scan, the correct symbology may not be enabled. To learn how to modify the default app settings, see the User Guide.*

Sync Data

To move files between your EDA51 and a computer:

1. Connect the EDA51 to your computer using a USB charge/communication accessory.
2. On the EDA51, swipe down from the top of the screen to see the notifications panel.
3. Touch the **Android System** USB charging notification twice to open the options menu.
4. Select either **Transfer files** or **Transfer photos (PTP)**.
5. Open the file browser on your computer.
6. Browse to the EDA51. You can now copy, delete, and move files or folders between your computer and EDA51 as you would with any other storage drive (e.g., cut and paste or drag and drop).

Note: *When Provisioning mode is turned off, some folders are hidden from view in the file browser.*

Restart the Mobile Computer

You may need to restart the mobile computer to correct conditions where an application stops responding to the system or the computer seems to be locked up.

1. Press and hold the **Power** button until the options menu appears.
2. Select **Restart**.

To restart the computer if the touch panel display is unresponsive:

- Press and hold the **Power** button for approximately 8 seconds until the computer restarts.

Note: *To learn about advanced reset options, see the User Guide.*

Support

To search our knowledge base for a solution or log into the Technical Support Portal and report a problem, go to www.hsmcontactsupport.com.

Documentation

Product documentation is available at www.honeywellaidc.com.

Limited Warranty

For warranty information, go to www.honeywellaidc.com and click **Resources > Product Warranty**.

Patents

For patent information, see www.hsmpats.com.

Trademarks

Android is a trademark of Google LLC.

Disclaimer

Honeywell International Inc. (“HII”) reserves the right to make changes in specifications and other information contained in this document without prior notice, and the reader should in all cases consult HII to determine whether any such changes have been made. The information in this publication does not represent a commitment on the part of HII.

HII shall not be liable for technical or editorial errors or omissions contained herein; nor for incidental or consequential damages resulting from the furnishing, performance, or use of this material. HII disclaims all responsibility for the selection and use of software and/or hardware to achieve intended results.

This document contains proprietary information that is protected by copyright. All rights are reserved. No part of this document may be photocopied, reproduced, or translated into another language without the prior written consent of HII.

Copyright © 2019 Honeywell International Inc. All rights reserved.