

SR5600

Bluetooth Ring Scanner

[USER GUIDE]

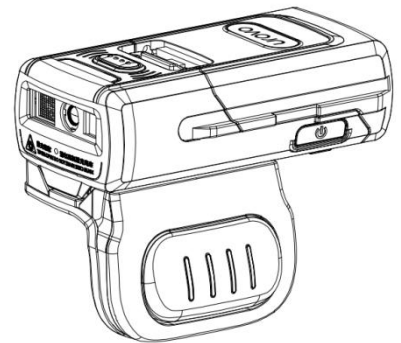

Revision History

Change	Date	Description	Author
-2	2021.06.15	First version	Liang Wang
-1	2021.07.12	Initial Release	Nolan Luo
0	2021.07.15	Version 1.0 Revision	Nolan Luo
1	2021.07.29	Version 1.1 Revision	Nolan Luo
2	2021.08.08	Version 1.2 Revision <ul style="list-style-type: none"> ✧ Add prefix/suffix setting ✧ Barcode type ✧ Bluetooth name modifying 	Nolan Luo

Index

Revision History.....	2
1. Getting Started.....	1
1.1 Introduction.....	1
1.2 Unpacking.....	1
1.3 Configuration Features.....	1
1.4 LED Status Indications.....	2
1.5 Buzzer, vibration status.....	3
1.6 Battery installation instructions.....	3
1.7 Trigger Assembly.....	4
1.7.1 Installation instructions.....	4
1.7.2 Adjust finger strap.....	4
1.8 Direct Charger installation instructions.....	5
1.8.1 Powering ON/OFF.....	5
1.9 Bluetooth Communications.....	6
1.9.1 Introduction.....	6
1.9.2 Bluetooth Connection Modes.....	6
1.9.3 Pairing Mode.....	7
1.9.4 Bluetooth Name Modifying.....	7
2. Setup.....	8
2.1. HID Bluetooth Connection to iOS/iPad/iPhone.....	8
2.2 HID Bluetooth Connection to Android.....	8
2.3 HID Bluetooth Connection to Windows.....	9
2.4 Power Save.....	12
2.5 Delay 01~10 ms to send (HID).....	12
2.6 Firmware Version.....	12
2.7 Restore Factory Setting.....	13
2.8. Indicators & Beeper setting.....	13
2.8.1. Power on alarming.....	13
2.8.2. LED indicator.....	14
2.8.3. Beeper setting.....	14
3. Scanner Setting.....	16
3.1. Scanning Type.....	16
3.2. Illumination&Aiming setting.....	16
3.3. Illumination level.....	17
3.4. Suffix&Prefix.....	18
4. Symbologies.....	21
Code 39.....	21
Code 39 Full ASCII.....	22
PDF417.....	22
Data Matrix.....	23
Interleaved 2 of 5.....	23
MaxiCode.....	24
UPC/EAN.....	25

Code 93.....	26
Code 11.....	26
Matrix 2 of 5.....	28
NEC 2of 5.....	28
Hanxicode.....	29
GridMatrix.....	29
Aztec Code.....	30
MicroPDF417.....	30
MSI/PLESSEY.....	31
Dotcode.....	31
Standard 2 of 5.....	32
CodaBlock_F.....	32
CodaBlock_A.....	33
GS1 DataBar-14.....	33
Codabar.....	34
Code 2 of 5.....	34
Trioptic.....	35
postnet.....	35
China Post.....	40
OCR.....	41
Decoding.....	41
OCR Pattern.....	42
OCR Fonts.....	43
OCR Character.....	44
OCR Character length : 00~FF.....	45

1. Getting Started

1.1 Introduction

This chapter describes the features of the SR5600 Ring Scanner and explains how to install and charge the battery, capture data and reset the SR5600.

1.2 Unpacking

Carefully remove all protective material from around the equipment and save the shipping container for later storage and shipping.

After opening the shipping box, inspect the contents. You should have received the following:

- SR5600
- Battery
- Simple Operation Guide
- USB Cable
- Power adaptor
- Direct Charger

Inspect the equipment for damage. If you are missing any equipment or if you find any damaged equipment, contact Support immediately. See Website: <http://en.urovo.com> or local agent.

1.3 Configuration Features

Figure 1 SR5600 Trigger Configuration Features

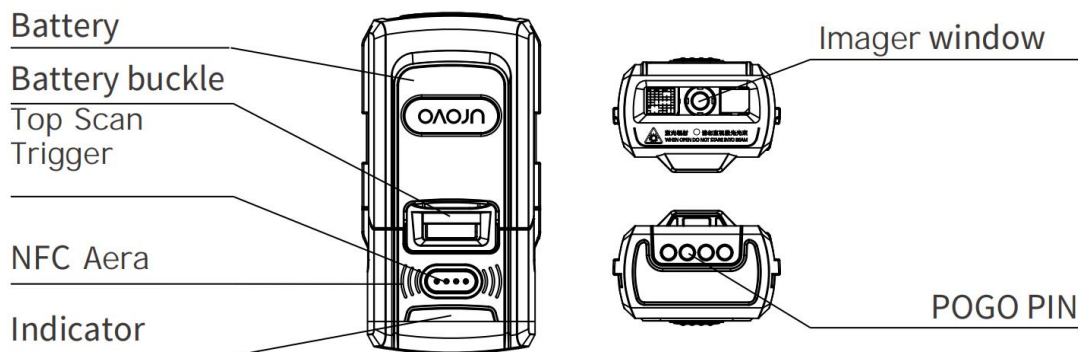

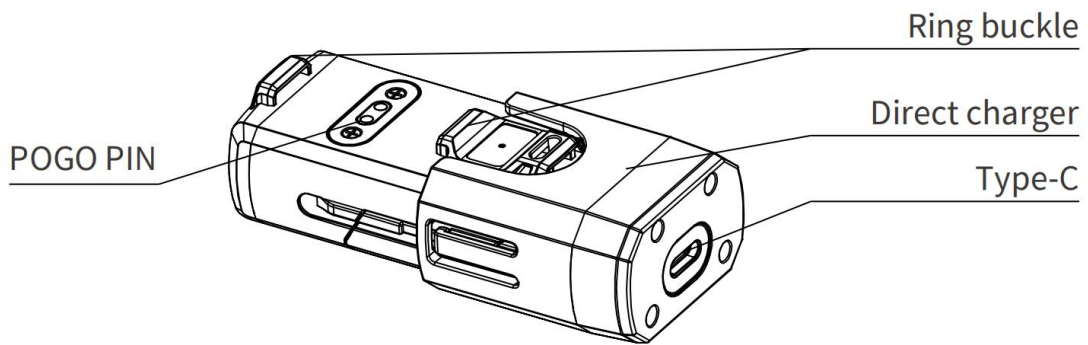
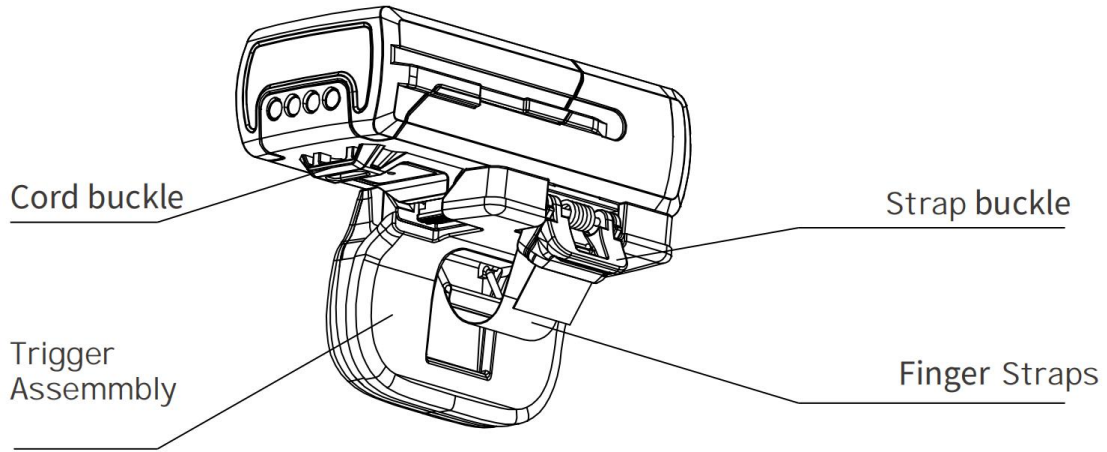

1.4 LED Status Indications

Status light	Description
Red indicator light is always on	Trigger button hold or charging
Red indicator light flashes once	Setup failure
Red indicator blinking twice	Alarming/Scanning when Bluetooth is not connected
Green indicator light flashes once	Scan bar code successfully
Green indicator light is always on	Battery fully charged
Blue indicator light keeps flashing	Bluetooth enters pairing mode
Blue indicator solid on	Successful Bluetooth connection

1.5 Buzzer, vibration status

Buzzer, vibration status	Description
Start-up sound + no vibration	Startup
One long buzz + vibration	Shutdown
One short buzz + vibration	Successful decoding
Two short buzz + no vibration	The battery is set successfully, the Bluetooth is connected successfully, and the Bluetooth is disconnected
One long buzz + no vibration	Setup failure
Four short beeps + vibration	Alarming/Scanning when Bluetooth is not connected

1.6 Battery installation instructions

Align the battery with the top of the SR5600 and insert it into the battery compartment. Slide the battery all the way into the SR5600 locking slot to ensure that the battery matches with SR5600.

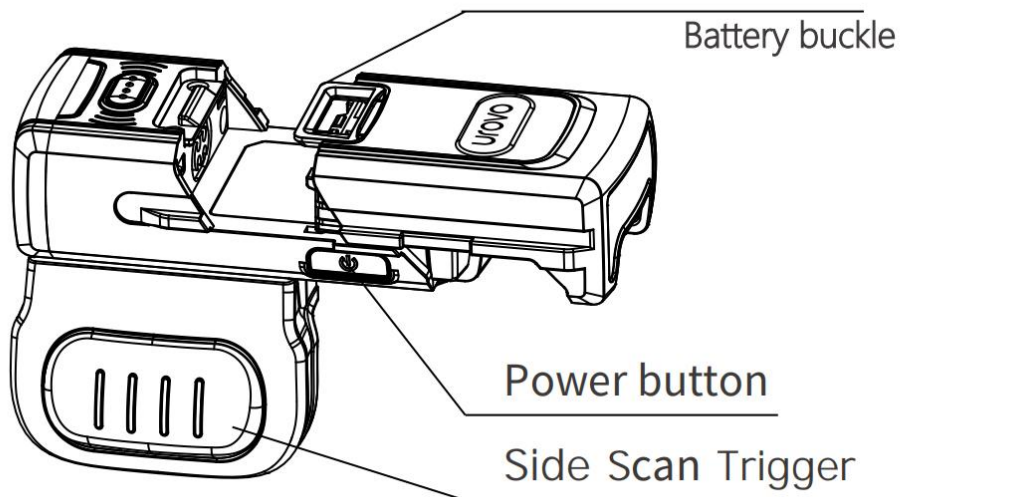

1.7 Trigger Assembly

1.7.1 Installation instructions

Align one end of the SR5600 lock catch and push the other end down until it clicks into place.

The trigger assembly can be installed as required. The following figure 1 is for the right finger, and figure 2 is for the left finger. Press the sliding buckle to remove the ring.

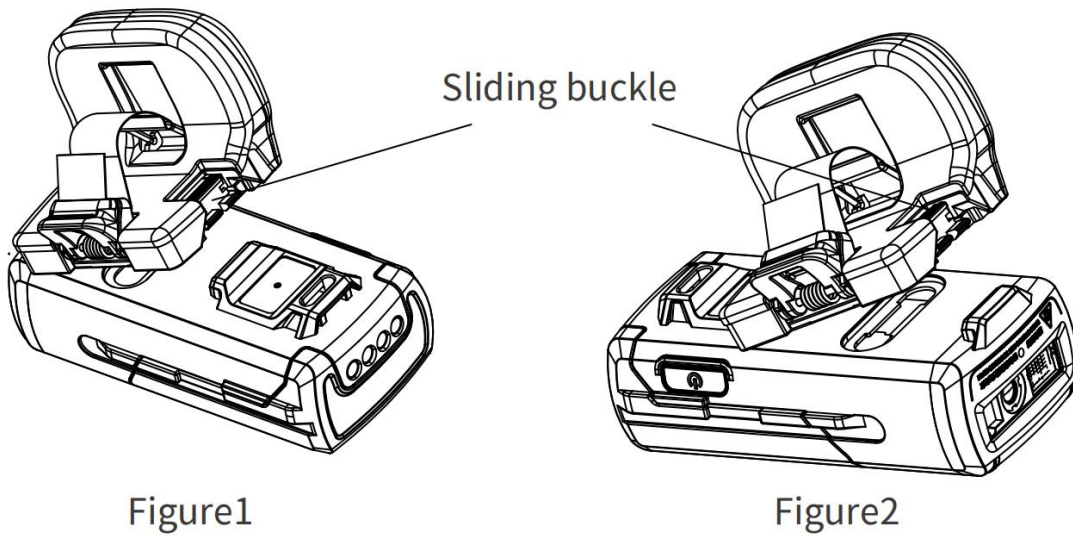

1.7.2 Adjust finger strap

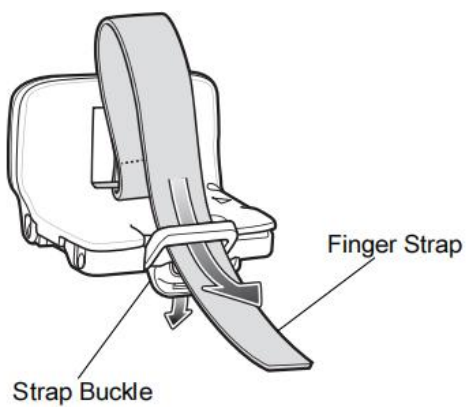

1.8 Direct Charger installation instructions

Insert the bottom of the SR5600 into the charger until it clips into place. Connect the Type-C interface at the end of the charger with the USB cable and Power adaptor. Normal charging starts when the indicator light indicates that the red light is always on.

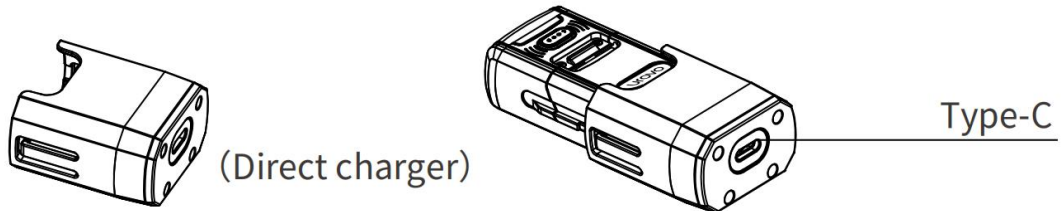

1.8.1 Powering ON/OFF

Long-press the power button for 2 second to boot, for 3 second to turn off.

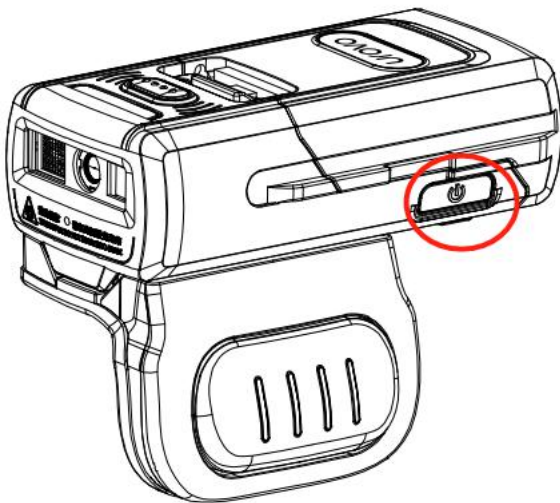

1.9 Bluetooth Communications

1.9.1 Introduction

This chapter provides information about the modes of operation and features available or Bluetooth communication between Ring Scanner and hosts. The chapter also includes the parameters necessary to configure the SR5600.

Scan a factory barcode to return all features to default values. See [page10](#).

Scan a version barcode to check the version number of the scanner. See [page10](#).

1.9.2 Bluetooth Connection Modes

The SR5600 Ring Scanner can connect to a host computer using the following Bluetooth modes, scan to switch the connection mode you need:

Human Interface Device(*HID MODE)

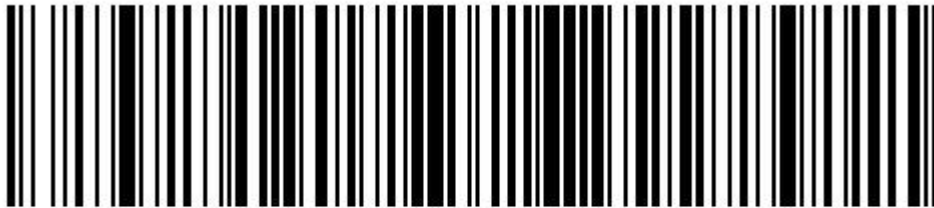

#~%INS:%4002S00%~#

Serial Port Profile(SPP MODE)

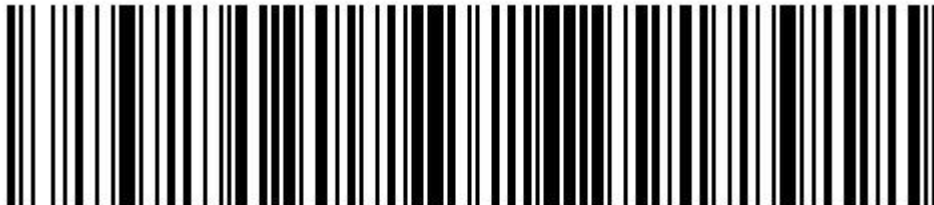

#~%INS:%4002S01%~#

Low Energy(BLE MODE)

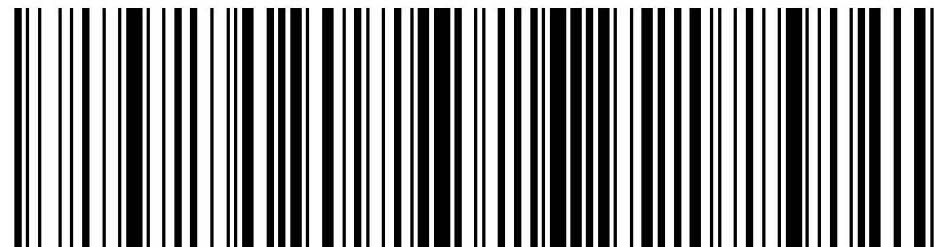

#~%INS:%4002S02%~#

1.9.3 Pairing Mode

Scan the following barcode to enter the pairing mode or release the connection.

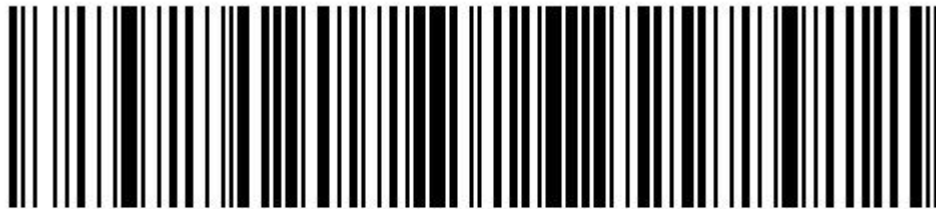

#~%INS:%4001S00%~#

1.9.4 Bluetooth Name Modifying

Generate the barcode to change the Bluetooth name, value = \$BT#SETSSID=M

M: Bluetooth name of Ring Scanner SR5600.

2. Setup

HID Setup

2.1. HID Bluetooth Connection to iOS/iPad/iPhone

1. Scan the barcode 'Pairing Mode' into connectable status.
2. Scan the HID MODE Barcode from this chapter.
3. Select Settings > General > Bluetooth(iOS)
4. Turn the iOS Bluetooth ON.
5. Select Bluetooth Settings and choose SR5600 from the list of discovered devices. The SR5600 displays as SR5600 - xxxx, where xxxx is the The last four digits of the Mac address.

2.2 HID Bluetooth Connection to Android

1. Scan the [barcode](#) 'Pairing Mode' into connectable status.
2. Scan the HID MODE [barcode](#) from this chapter.
3. Select Settings > Bluetooth(Android)
4. Turn the Android Bluetooth ON.
- 5 Select Bluetooth Settings and choose SR5600 from the list of discovered devices. The RS5100 displays as SR5600 - xxxxxx, where xxxxxx is the serial number.

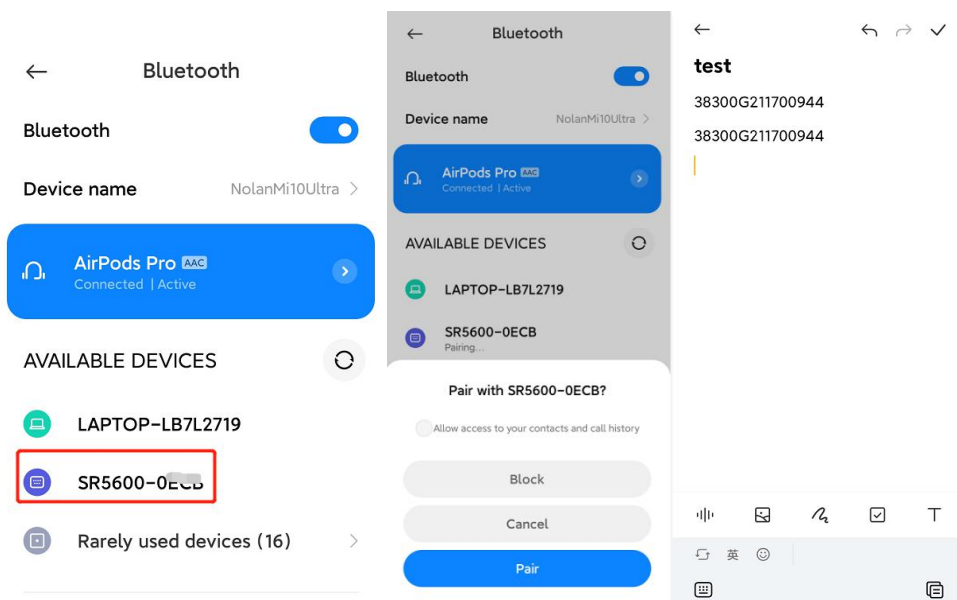

Fast-connect:

- *Make sure the Android's NFC is on and Ring Scanner is power on, Tap NFC to pair and connect.
- *Scan a QRCODE(Bluetooth MAC of urovo 's U2 wearable devices) to quick pair and connect.

2.3 HID Bluetooth Connection to Windows

To start the connection process aim the SR5600 at about 7" (18 cm) away from the computer screen and scan the [barcode](#) of the Pairing Mode.

The SR5600 Scan LEDs start flashing blue indicating that the SR5600 is attempting to establish connection with the computer. The following notifications display upon successful connection.

1. Scan the [barcode](#) 'Pairing Mode' into connectable status.
2. Scan the HID MODE [barcode](#) from this chapter.
- 3.

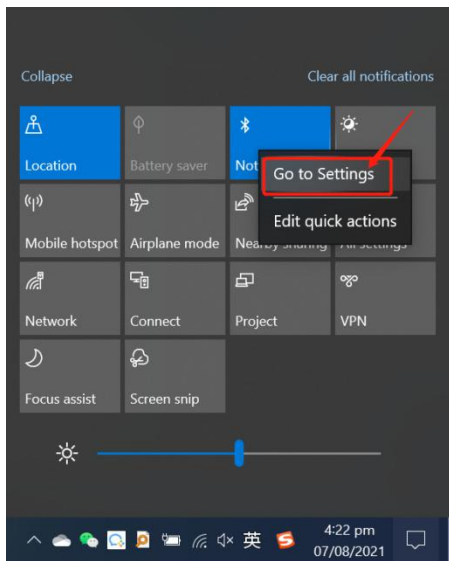

- 4.

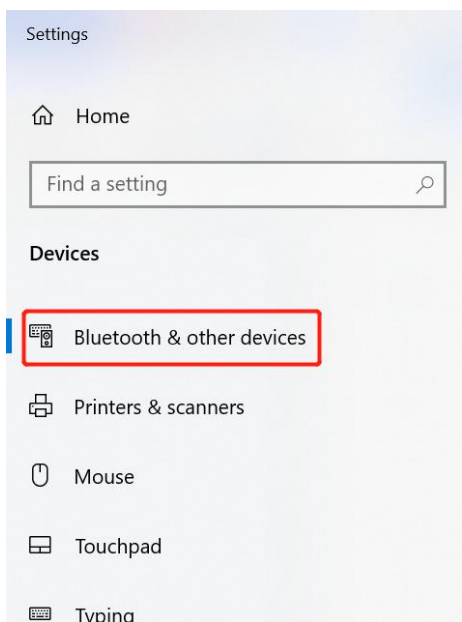

Bluetooth & other devices

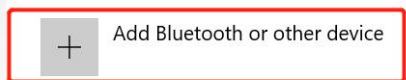

Bluetooth
 On
 Now discoverable as "DESKTOP-4JBKL70"

Mouse, keyboard, & pen

Logitech® Unifying Receiver
 — SR5600 0587

5.Default PIN code is 0000.

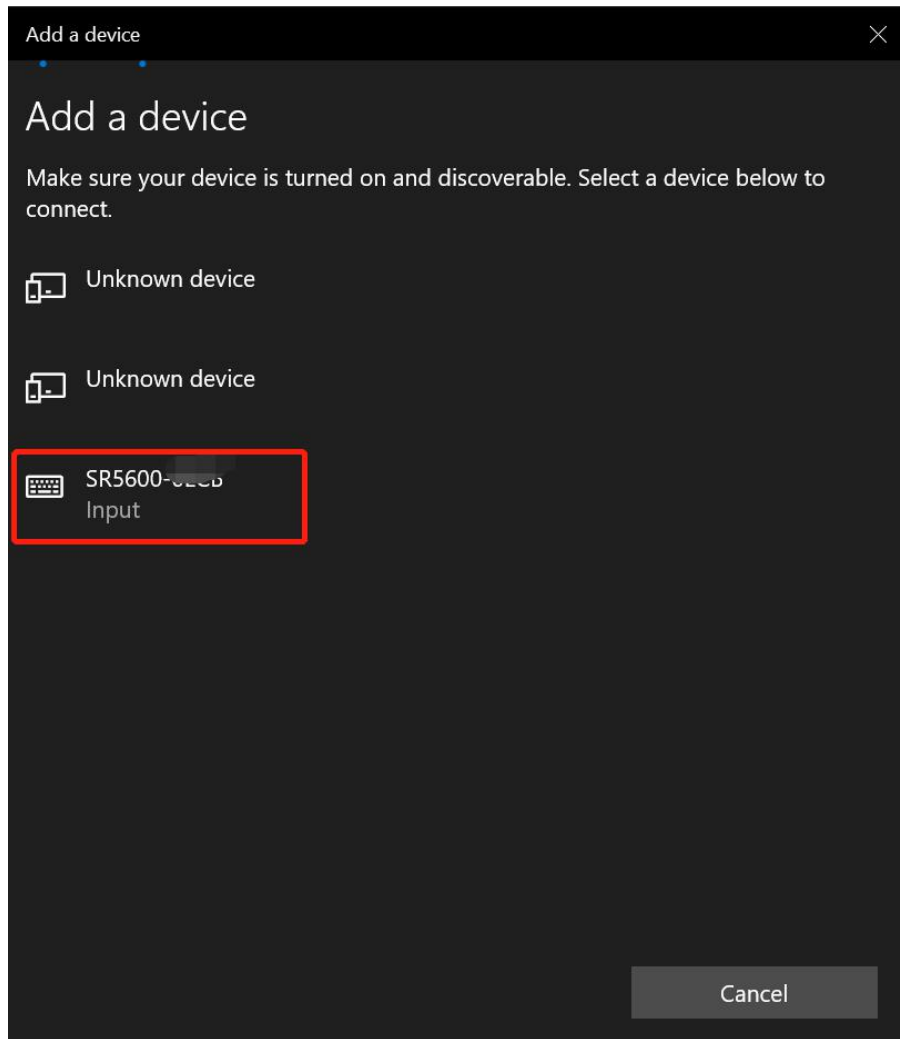

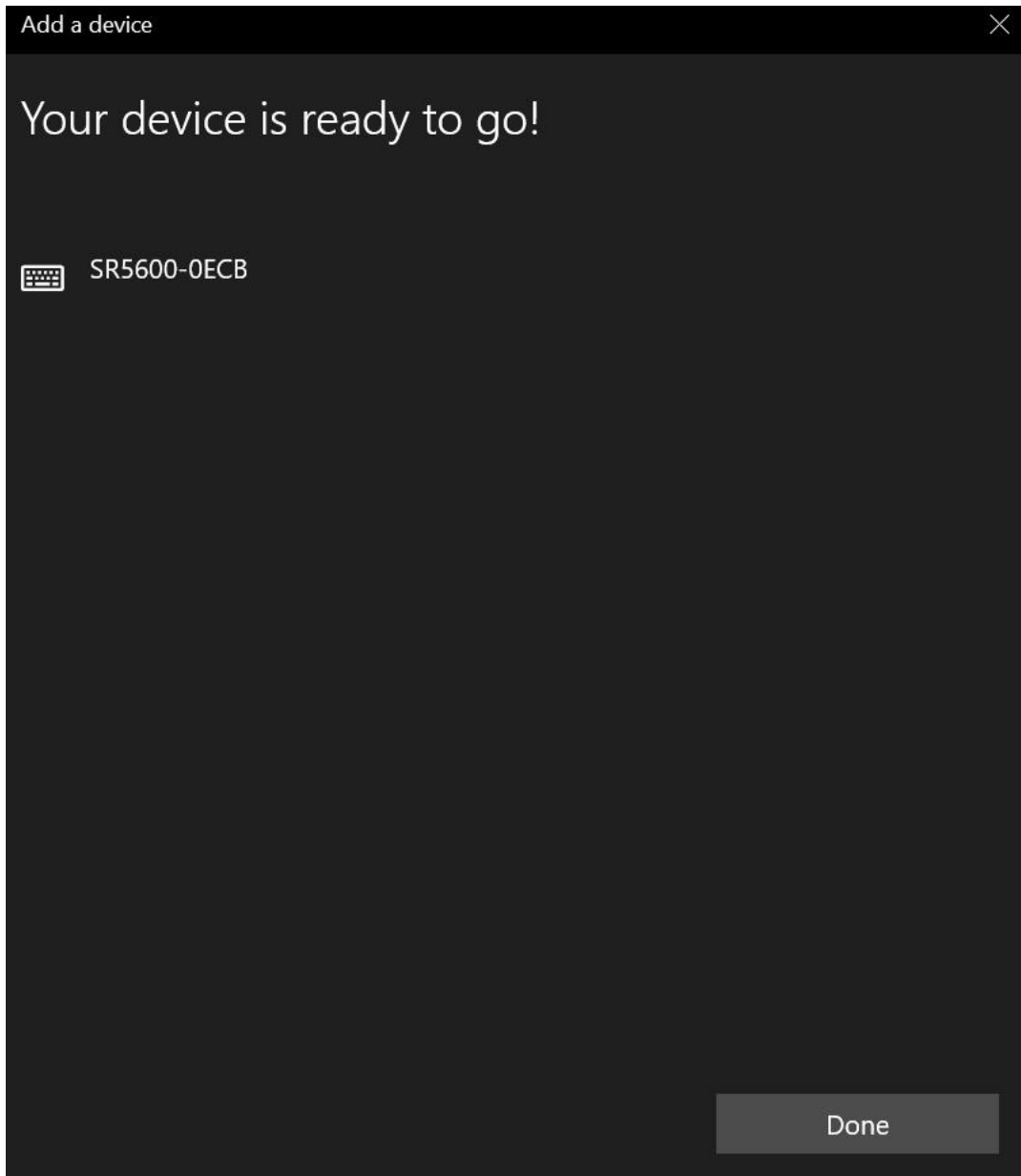

*New Text Document.txt - Notepad

File Edit Format View Help

9787505737488

<Test in text file.>

2.4 Power Save

If no Bluetooth connection is made within 5 minutes, the ring scanner will auto switch off.

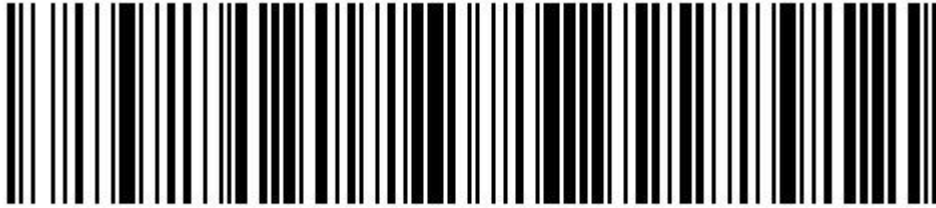

#~%INS:%4003S00%~#

Disable power off

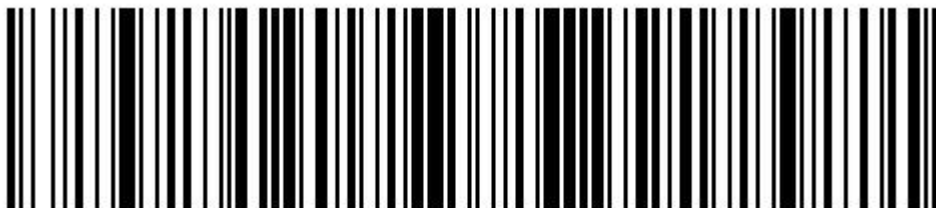

#~%INS:%4003S01%~#

*Enable power off

2.5 Delay 01~10 ms to send (HID)

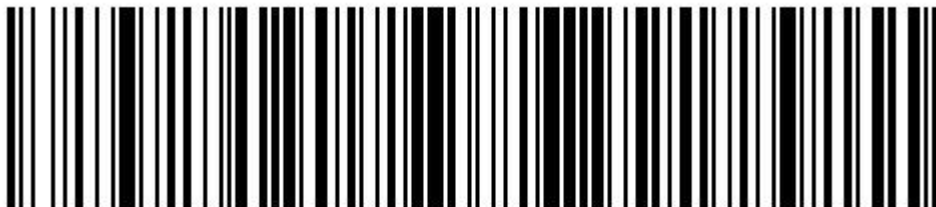

#~%INS:%4004S01%~#

*1ms

2.6 Firmware Version

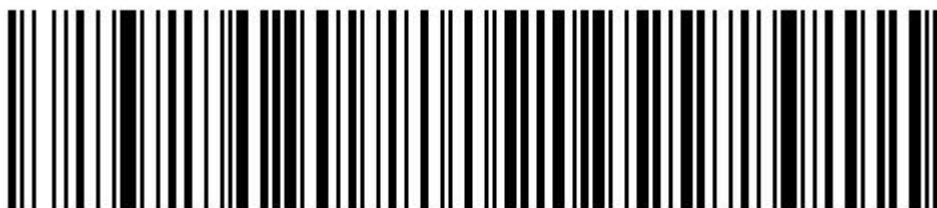

#~%INS:%FF02S00%~#

2.7 Restore Factory Setting



2.8. Indicators & Beeper setting

2.8.1. Power on alarming



2.8.2. LED indicator

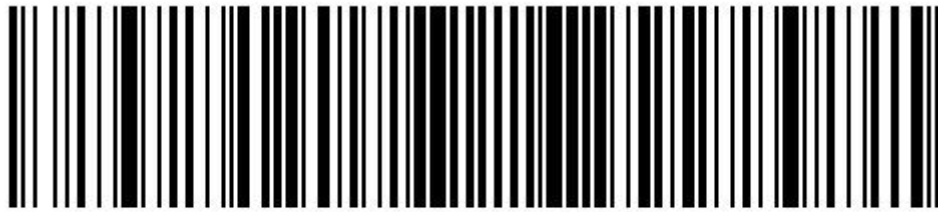

#~%INS:%0102S00%~#

OFF

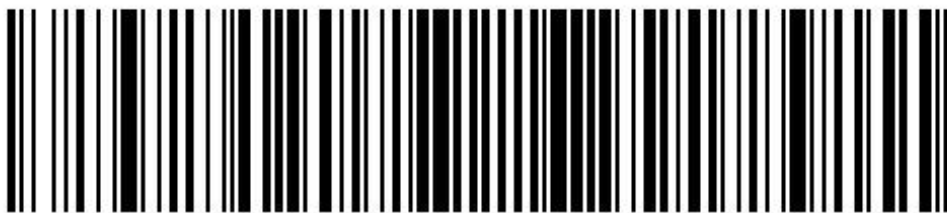

#~%INS:%0102S01%~#

*ON

2.8.3. Beeper setting



#~%INS:%0103S00%~#

OFF



#~%INS:%0103S01%~#

*ON

2.8.4. Duration

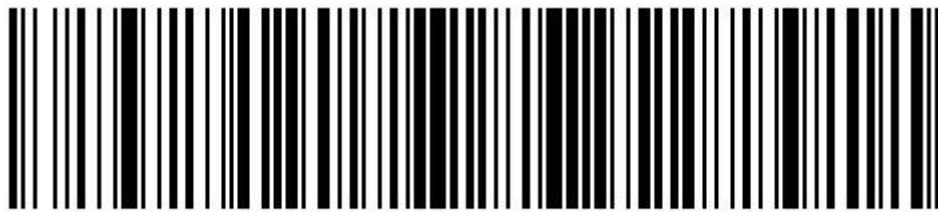

#~%INS:%0104S05%~#

*50ms

2.8.5. Volume Level

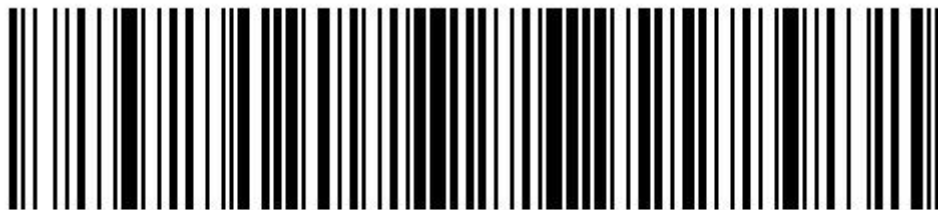

#~%INS:%0105S00%~#

Low



#~%INS:%0105S01%~#

Middle



#~%INS:%0105S02%~#

*High

3. Scanner Setting

3.1. Scanning Type

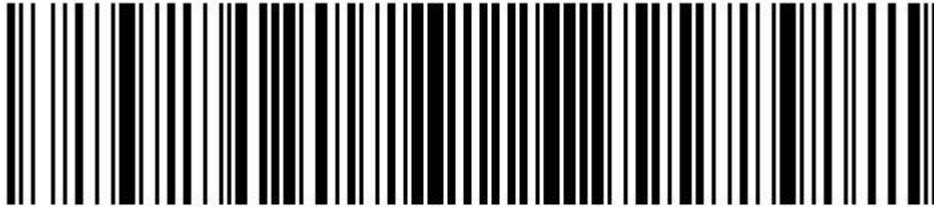

#~%INS:%0201S00%~#

Continuous Barcode Read

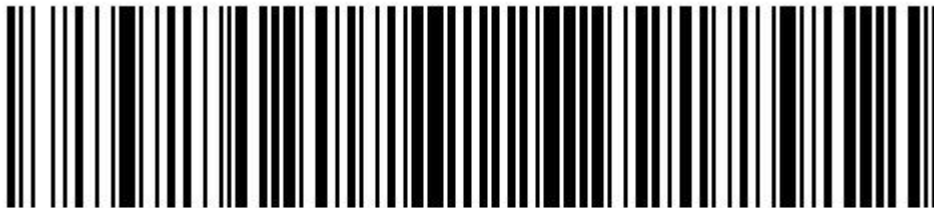

#~%INS:%0201S01%~#

Pluse

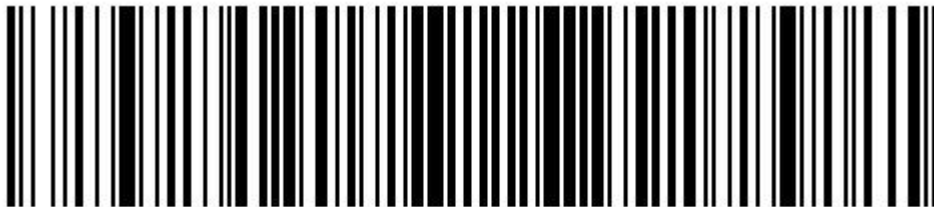

#~%INS:%0201S02%~#

*Normal(Manual)

3.2. Illumination&Aiming setting



#~%INS:%0302S00%~#

Disable both



#~%INS:%0302S01%~#

Laser aiming only



#~%INS:%0302S02%~#

Illumination only



#~%INS:%0302S03%~#

*Enable both

3.3. Illumination level

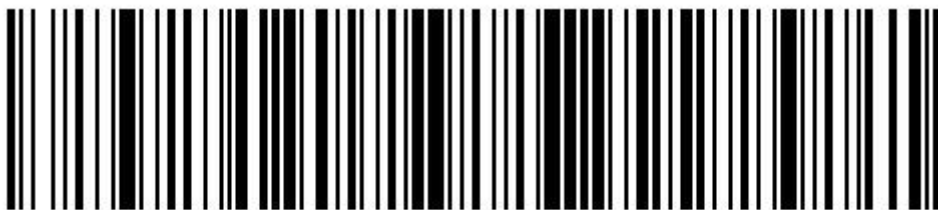

#~%INS:%0303S00%~#

Level 1



#~%INS:%0303S01%~#

Level 2



#~%INS:%0303S02%~#

*Level 3

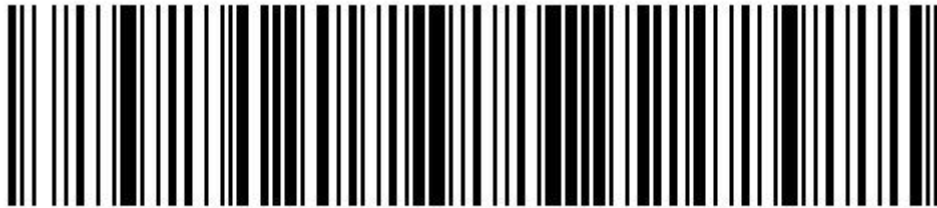

#~%INS:%0303S03%~#







Level 4

3.4. Suffix&Prefix

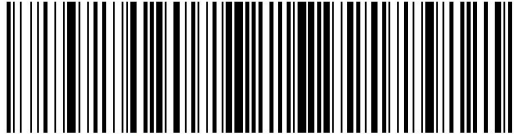
SR5600 can add 1 prefix and 2 suffix.

'*'represent default.

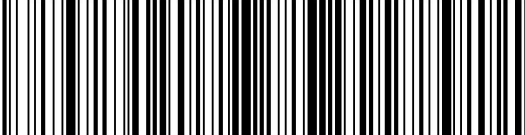
Multi-step			Single-step
Function	Description	Parameter	Description
Option %3001M %	Disable	00	<p>#~%INS:%3001S00%~#</p>
	Enable	01*	<p>#~%INS:%3001S01%~#</p>
Format %3002M %	<data><suffix 1><suffix 2>	00*	<p>#~%INS:%3002S00%~#</p>

	<data><suffix 1>	01	 #~%INS:%3002S01%~#
	<data><suffix 2>	02	 #~%INS:%3002S02%~#
	<prefix><data>	03	 #~%INS:%3002S03%~#
	<prefix><data> <suffix 1> <suffix 2>	04	 #~%INS:%3002S04%~#
	<prefix><data> <suffix 1>	05	 #~%INS:%3002S05%~#
	<prefix><data> <suffix 2>	06	 #~%INS:%3002S06%~#
Prefix %3003M %	Prefix value	00~FF	...
		00*	 #~%INS:%3003S00%~#
Suffix 1 %3004M %	suffix 1 value	00~FF	...
		0A*	 #~%INS:%3004S0A%~#

		0D	 <p>#~%INS:%3004S0D%~#</p>
Suffix 2 %3005M %	suffix 2 value	00~FF	...
		0D*	 <p>#~%INS:%3005S0D%~#</p>
		0A	 <p>#~%INS:%3005S0A%~#</p>

4. Symbologies

Code 39

To enable or disable Code39, scan the appropriate barcode below.



#~%INS:%0602S00%~#

*Disable Code 39

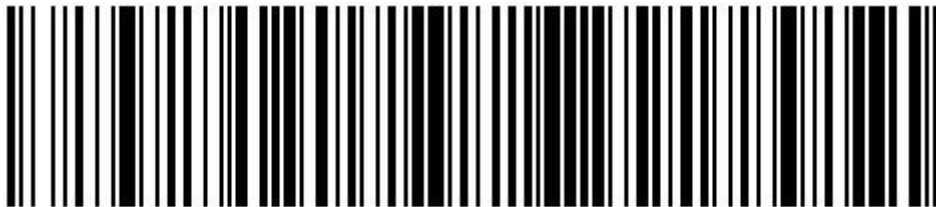

#~%INS:%0602S01%~#

1 Check digit



#~%INS:%0602S02%~#

2 Check digit



#~%INS:%0602S03%~#

*Do not Transmit Code39 Check Digit(Disable)



#~%INS:%0602S04%~#

*Do not Transmit Code39 2 Check Digit(Disable)

Code 39 Full ASCII

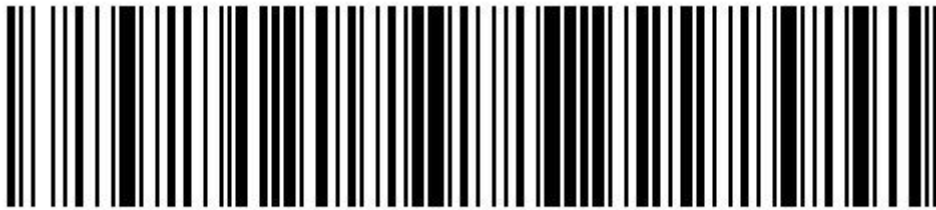

#~%INS:%0603S00%~#

*Disable Code 39 Full ASCII

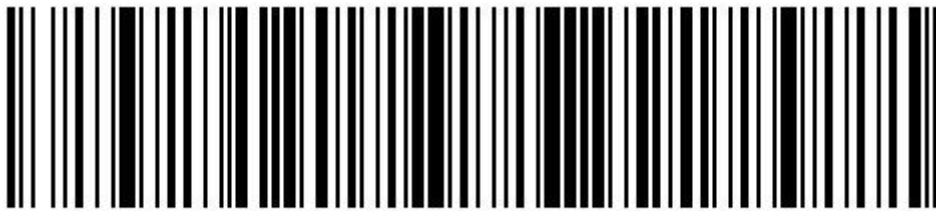

#~%INS:%0603S01%~#

Enable Code39 Full ASCII

PDF417



#~%INS:%0701S00%~#

Disable PDF417



#~%INS:%0701S01%~#

*Enable PDF417

Data Matrix

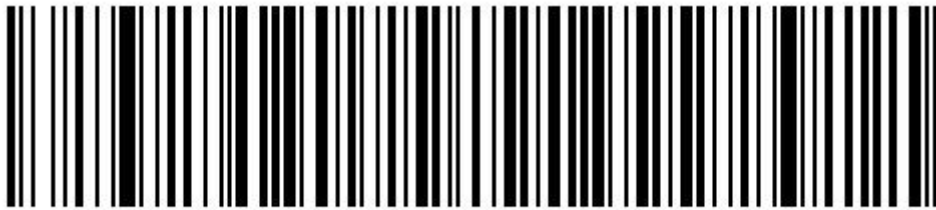

#~%INS:%0A01S00%~#

Disable Data Matrix

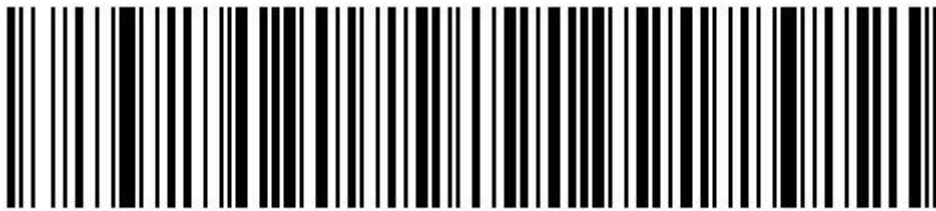

#~%INS:%0A01S01%~#

*Enable Data Matrix

Interleaved 2 of 5



#~%INS:%0B01S00%~#

*Disable ITF



#~%INS:%0B01S01%~#

Enable ITF

MaxiCode



#~%INS:%0C01S00%~#

*Disable MaxiCode



#~%INS:%0C01S01%~#

Enable MaxiCode

UPC/EAN

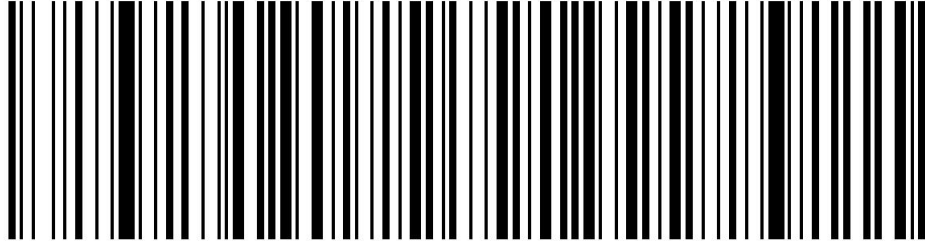

#~%INS:%0D01S00%~#

Disable UPC/EAN

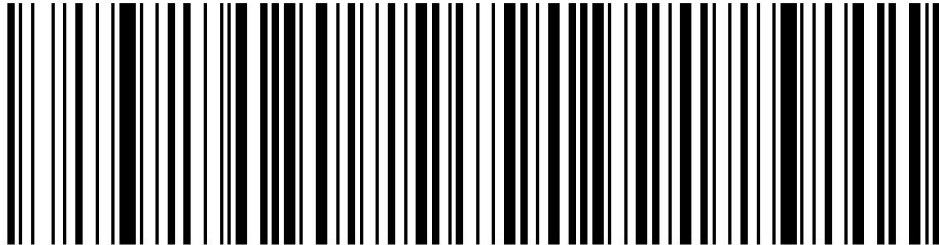

#~%INS:%0D01S01%~#

*Disable UPC/EAN

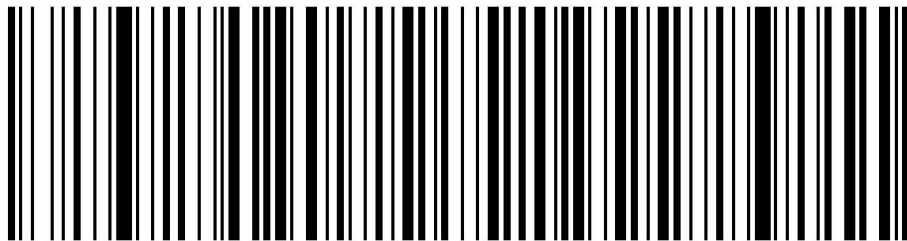

#~%INS:%0D02S00%~#

Disable 2and5 digit supplemental

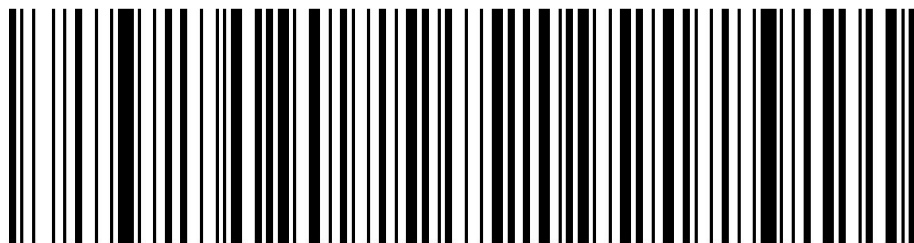

#~%INS:%0D02S01%~#

Enable 2 and 5 supplemental

Code 93

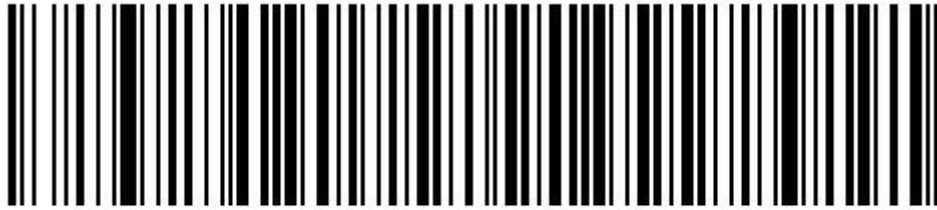

#~%INS:%0F01S00%~#

*Disable Code 93

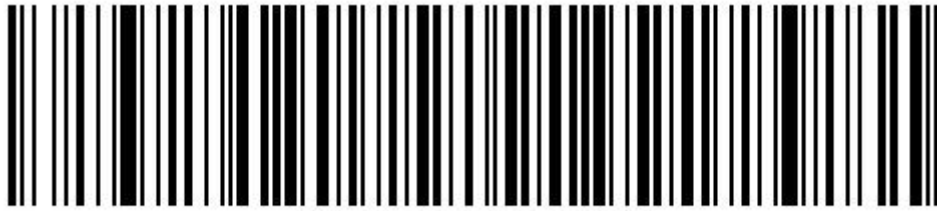

#~%INS:%0F01S01%~#

Enable Code 93

Code 11



#~%INS:%1001S00%~#

*Disable Code11

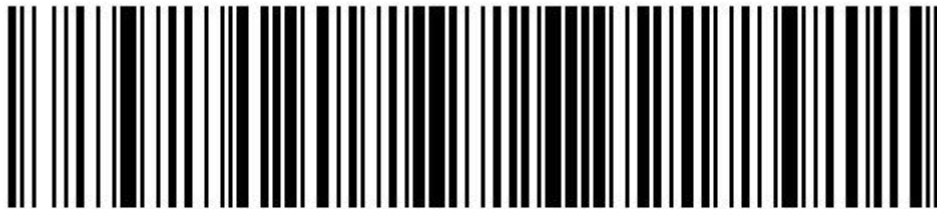

#~%INS:%1001S01%~#

Enable Code11

Check digit and transmit



#~%INS:%1002S00%~#

Disable Code11



#~%INS:%1002S01%~#

*1 check digit

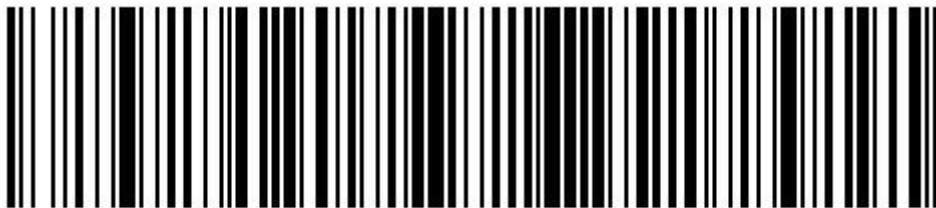

#~%INS:%1002S02%~#

2 check digit

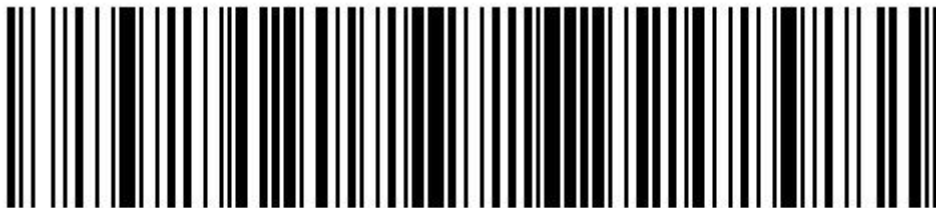

#~%INS:%1002S03%~#

Do not transmit 1 check digit



#~%INS:%1002S04%~#

Do not transmit 2 check digit

Matrix 2 of 5



#~%INS:%1101S00%~#

*Disable Matrix 2 of 5



#~%INS:%1101S01%~#

Enable Matrix 2 of 5

NEC 2 of 5



#~%INS:%1201S00%~#

*Disable NEC 2 of 5



#~%INS:%1201S01%~#

Enable NEC 2 of 5

Hanxincode

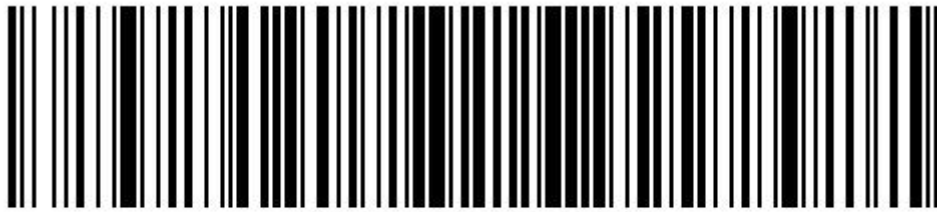

#~%INS:%1301S00%~#

*Disable Hanxin Code



#~%INS:%1301S01%~#

Enable Hanxin Code

GridMatrix

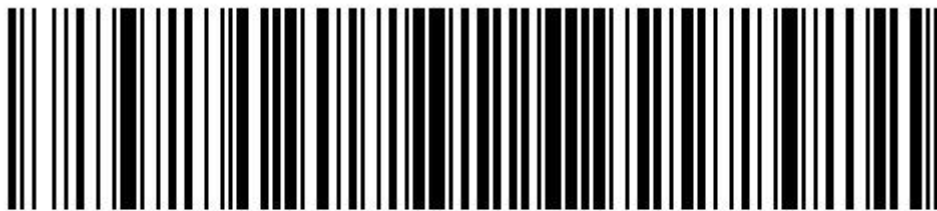

#~%INS:%1401S00%~#

*Disable GridMatrix



#~%INS:%1401S01%~#

Enable GridMatrix

Aztec Code



#~%INS:%1501S00%~#

*Disable Aztec Code



#~%INS:%1501S01%~#

Enable Aztec Code

MicroPDF417

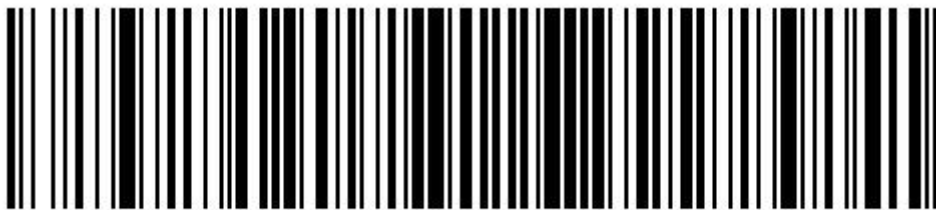

#~%INS:%1701S00%~#

*Disable Micro PDF417

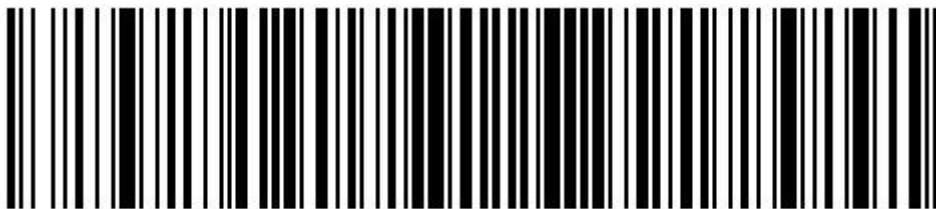

#~%INS:%1701S01%~#

Enable Micro PDF417

MSI/PLESSEY

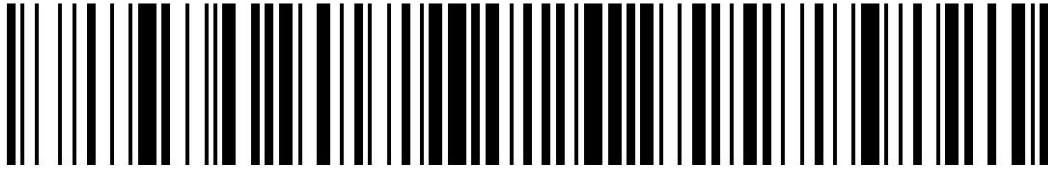

#~INS:%2101S00%~#

Disable MSI/PLESSEY(*)

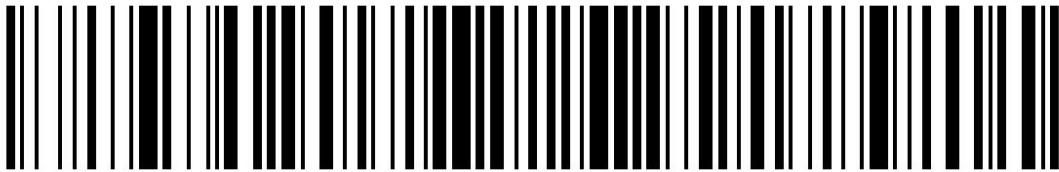

#~INS:%2101S01%~#

Enable MSI/PLESSEY

Dotcode

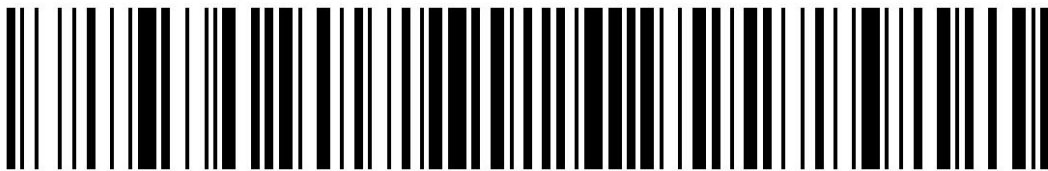

#~INS:%2201S00%~#

Disable Dotcode(*)

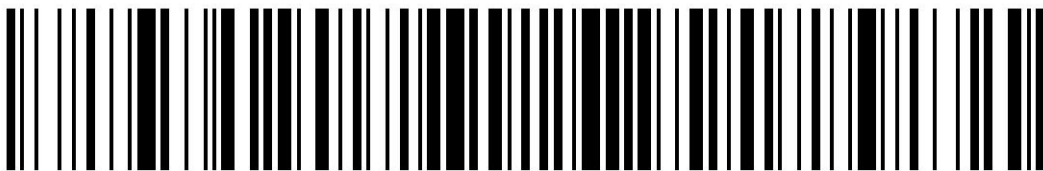

#~INS:%2201S01%~#

Enable Dotcode

Standard 2 of 5

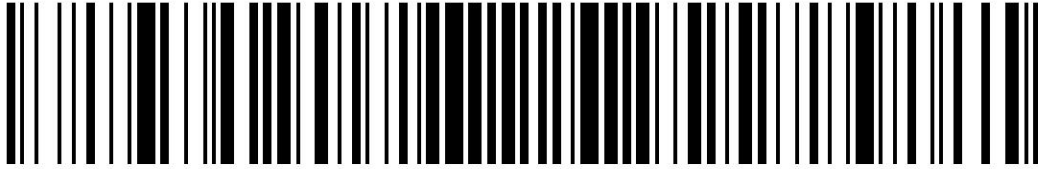

#~INS:%2301S00%~#

Disable Standard 2 of 5

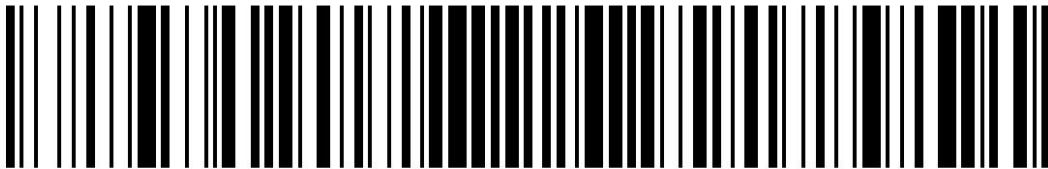

#~INS:%2301S01%~#

Disable Standard 2 of 5

CodaBlock_F



#~%INS:%1801S00%~#

*Disable CodaBlock_F



#~%INS:%1801S01%~#

Enable CodaBlock_F

CodaBlock_A



#~%INS:%1901S00%~#

*Disable CodaBlock_A



#~%INS:%1901S01%~#

Enable CodaBlock_A

GS1 DataBar-14



#~%INS:%1A01S00%~#

*Disable GS1 DataBar-14

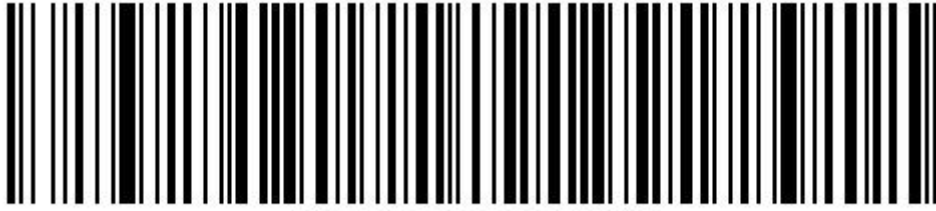

#~%INS:%1A01S01%~#

Enable GS1 DataBar-14

Codabar

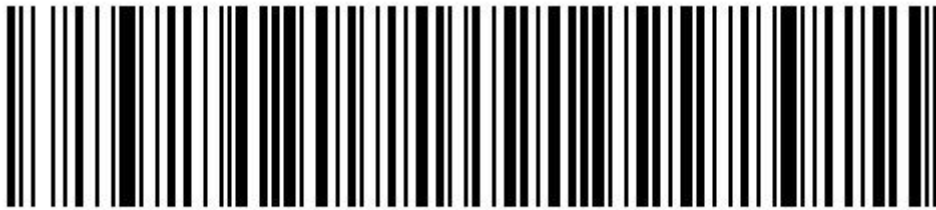

#~%INS:%1B01S00%~#

*Disable Codabar

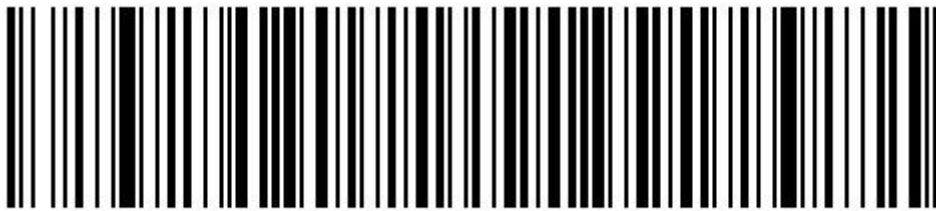

#~%INS:%1B01S01%~#

Enable Codabar

Code 2 of 5



#~%INS:%1C01S00%~#

*Disable code 2 of 5



#~%INS:%1C01S01%~#

Enable code 2 of 5

Trioptic

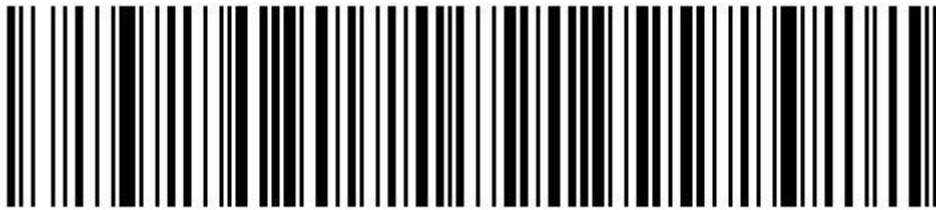

#~%INS:%1D01S00%~#

*Disable Trioptic

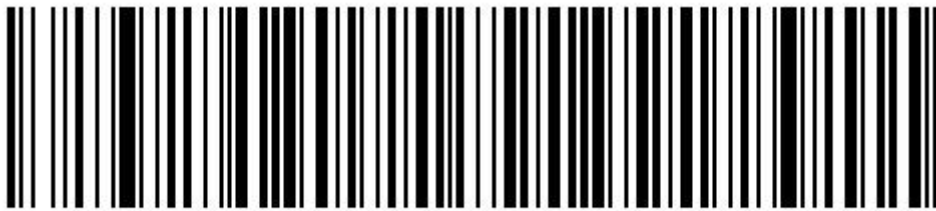

#~%INS:%1D01S01%~#

Enable Trioptic

postnet



#~%INS:%1E01S00%~#

*Disable postnet



#~%INS:%1E01S01%~#

Australian Post

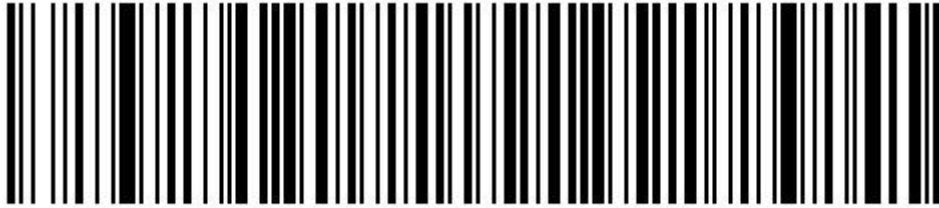

#~%INS:%1E01S02%~#

Royal Mail(BPO-4-State)

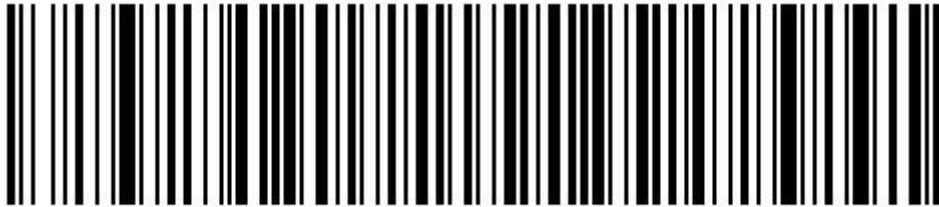

#~%INS:%1E01S03%~#

Japan Post

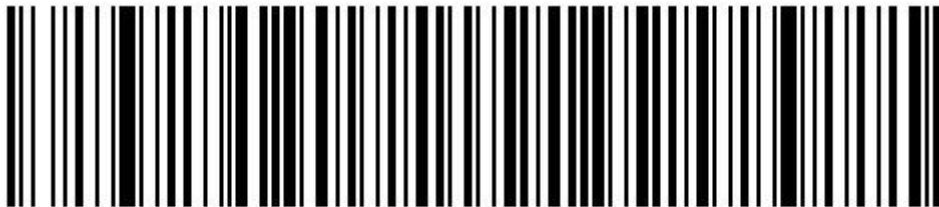

#~%INS:%1E01S04%~#

Dutch Post(KIX code)



#~%INS:%1E01S05%~#

US Planet



#~%INS:%1E01S06%~#

US Postnet

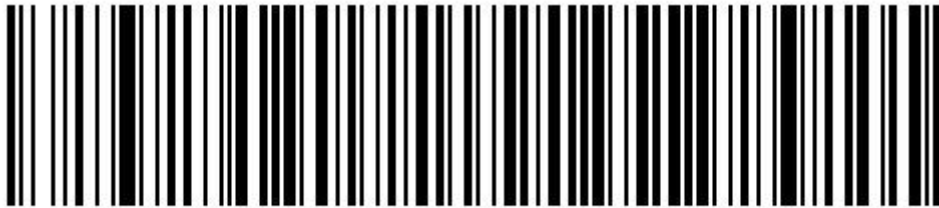

#~%INS:%1E01S07%~#

US4State FICS(UPUID-Tag)

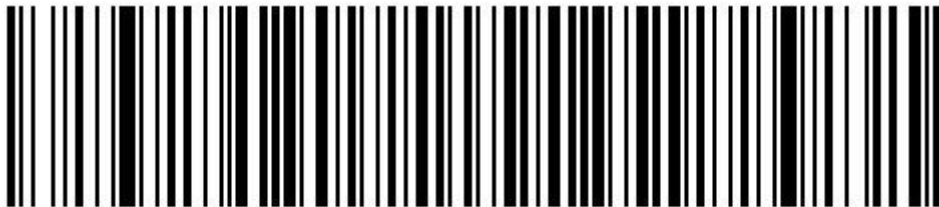

#~%INS:%1E01S08%~#

USPS 4CB(Intelligent Mail)

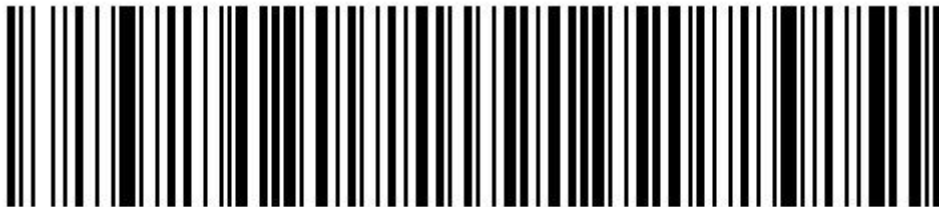

#~%INS:%1E01S09%~#

Canadian Post



#~%INS:%1E01S0A%~#

Planet,Postnet



#~%INS:%1E01S0B%~#

Planet,UPU

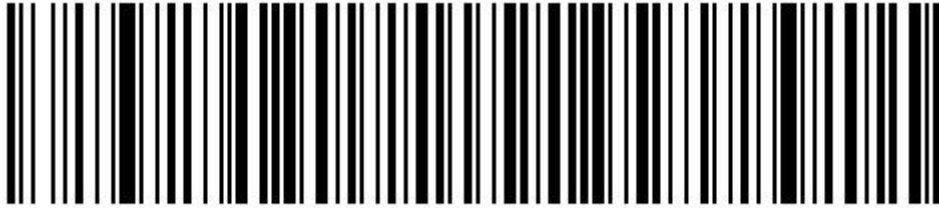

#~%INS:%1E01S0C%~#

Postnet,UPU

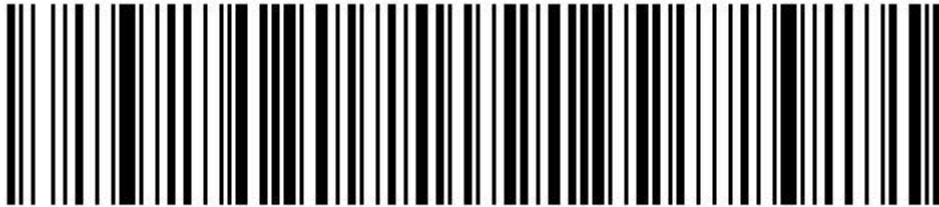

#~%INS:%1E01S0D%~#

Planet,USPS 4CB

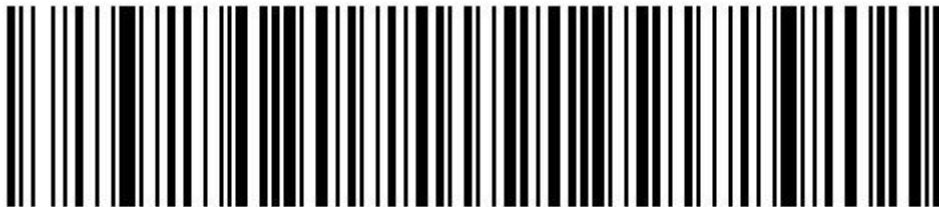

#~%INS:%1E01S0E%~#

Postnet,USPS 4CB

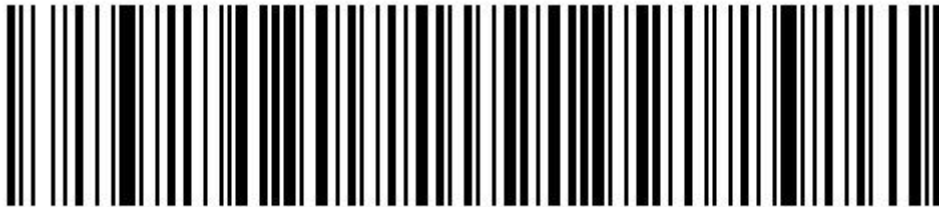

#~%INS:%1E01S0F%~#

UPU,USPS 4CB



#~%INS:%1E01S10%~#

Planet,Postnet,UPU

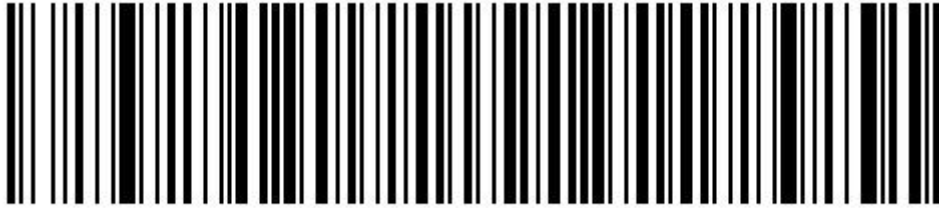

#~%INS:%1E01S11%~#

Planet,Postnet,USPS 4CB

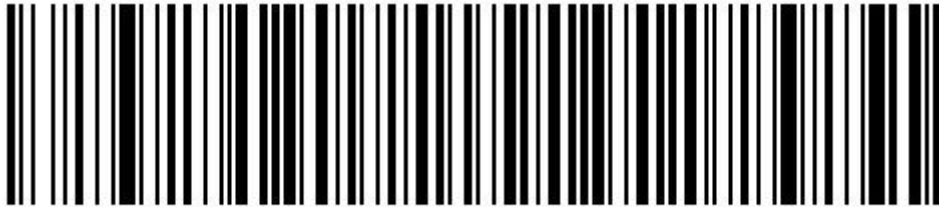

#~%INS:%1E01S12%~#

Planet,UPU,USPS 4CB

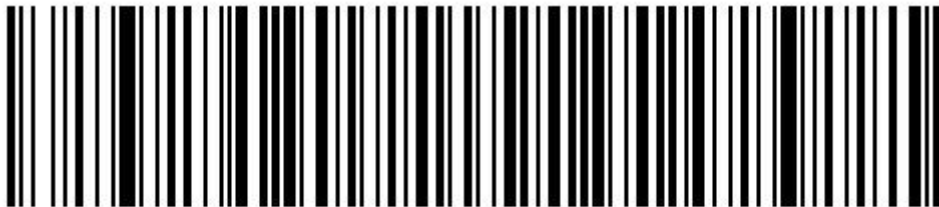

#~%INS:%1E01S13%~#

Postnet,UPU,UPS 4CB



#~%INS:%1E01S14%~#

Planet,Postnet,UPU,USPS 4CB

China Post

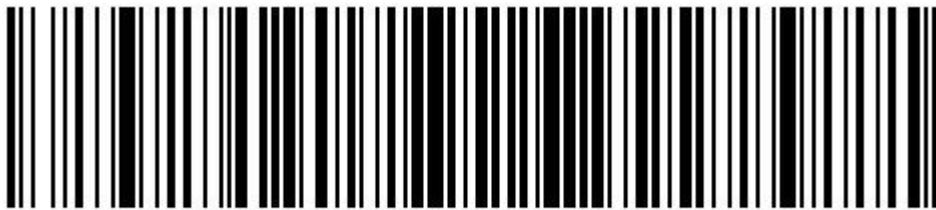

#~%INS:%2001S00%~#

*Disable China Post

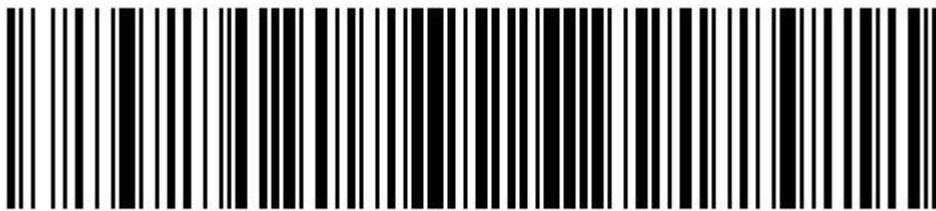

#~%INS:%2001S01%~#

Enable China Post

OCR

Decoding



#~%INS:%1F01S00%~#

*Disable OCR



#~%INS:%1F01S01%~#

Normal



#~%INS:%1F01S02%~#

Inverse



#~%INS:%1F01S03%~#

Both

OCR Pattern



#~%INS:%1F02S00%~#

User Defined



#~%INS:%1F02S01%~#

*Passport



#~%INS:%1F02S02%~#

ISBN



#~%INS:%1F02S03%~#

Price Field



#~%INS:%1F02S04%~#

MicrE-13 B

OCR Fonts

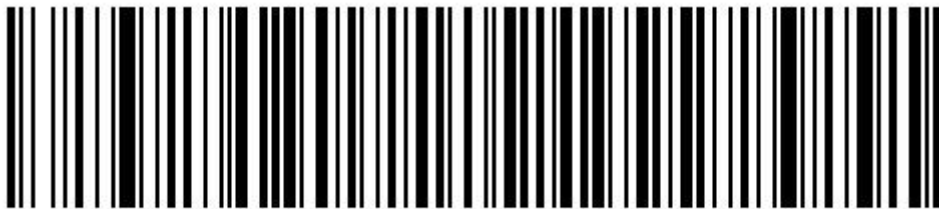

#~%INS:%1F03S00%~#

OCR-A

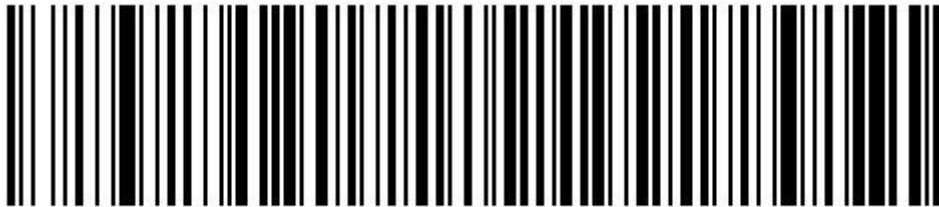

#~%INS:%1F03S01%~#

OCR-B

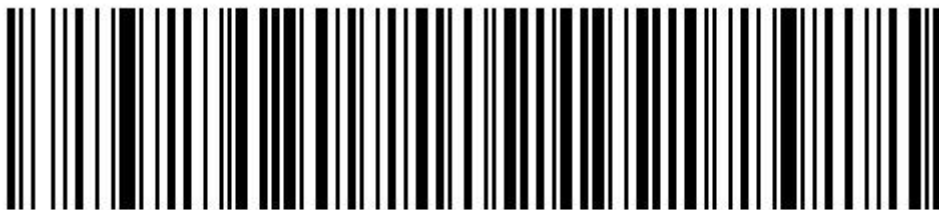

#~%INS:%1F03S02%~#

*OCR-A or B



#~%INS:%1F03S03%~#

MICR



#~%INS:%1F03S04%~#

SEMI

OCR Character

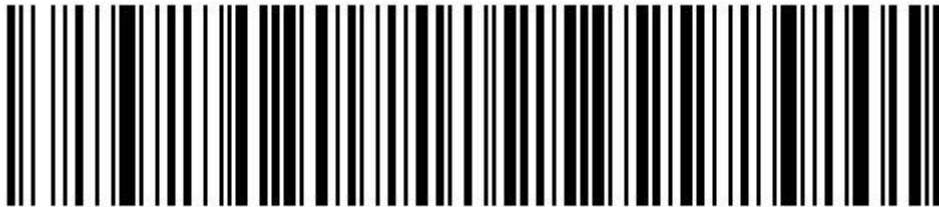

#~%INS:%1F04S00%~#

Numeric



#~%INS:%1F04S01%~#

Alpha



#~%INS:%1F04S02%~#

Alphanumeric



#~%INS:%1F04S03%~#

*Any (include space)

OCR Character length : 00~FF



#~%INS:%1F05S12%~#

*18