

Syndicate's MOM 6024 TP is a non-transferable tamper-proof label for on metal applications demanding a small form factor and good read range. Supplied in roll form with a high performance permanent adhesive as finished label, it can be encoded and printed with typical RFID printers that are capable of printing labels.

These labels feature a film face to print logos, product information, or scannable barcodes directly on the label and its additional flexibility for curved surfaces makes it perfect for tracking a variety of transit items.

With good performance on metal, this product is ideal for tracking assets in the healthcare, IT (Information Technology), oil & gas industries, industrial manufacturing, and many other industry verticals.

**TYPICAL APPLICATIONS**

Only for metal surfaces

- Indoor Asset Management: IT Assets, furniture's, home appliances and kitchen equipment
- Automotive: Components, spare parts and RTI's
- Healthcare: Hospital Assets & Equipment's
- Industrial: Metal assets, structural steel and RTI's
- Retail: RTI's

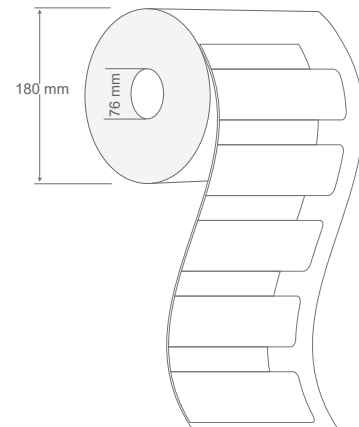

PHYSICAL SPECIFICATION	
Face Stock	Printable white PET, resin ribbon is recommended
Label Sizes	60 x 24 x 1.2 mm 2.36 x 0.94 x 0.047 in
Adhesive	High performance acrylic adhesive
Weight	0.6 g
Delivery format	Roll form
No. of Labels/ Reel	500 pcs
Label Pitch	35.75 mm / 1.41 in
Core inner diameter	76 mm / 3 in
Roll outer diameter	180 mm / 7.08 in

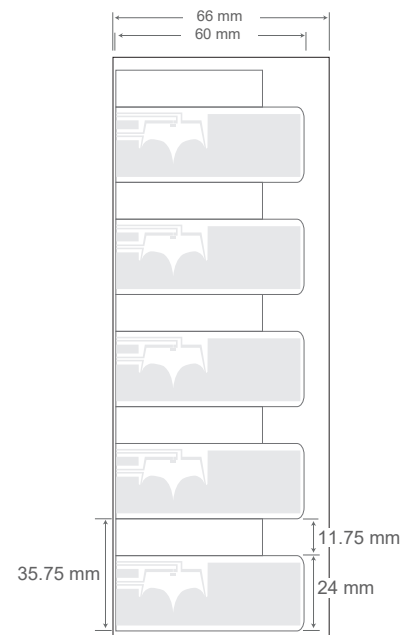

## RF SPECIFICATION

Mode of Operation	Passive
Device type	Class 1 Gen 2 Passive UHF RFID transponder
Air interface protocol	EPC Global Class 1 Gen 2 ISO 18000-6C
Operational frequency	ETSI : 865-868 MHz FCC : 902-928 MHz
IC type*	NXP UCODE 8
Memory configuration	Upto 128 bits
Data Retention	Upto 20 years
Write cycle endurance	100,000
Read range (2W ERP)**	ETSI: On Metal Upto 1.55 m FCC: On Metal Upto 1.7 m
Applicable Surface Materials	Metallic surfaces

## ENVIRONMENTAL RESISTANCE

Operating Temperature	-20°C to +70°C / -4°F to +158°F
Withstands Exposure To	95% humidity, 60°C × 100 h, 50% humidity, 80°C × 100 h
Peak Temperature	+80°C (Label remains securely attached with object. No physical or performance changes observed.)
Adhesive Service Temperature	-20°C to +70°C / -4°F to +158°F
Recommended Application Temperature	+10°C to +38°C
Water Resistance	IP67
Chemical Resistance	Resistant to chemical solvents and moisture
Ideal Storage Condition	+20°C / 50% RH
Expected Lifetime	Years in normal operating conditions

## PRODUCT INSTALLATION

Attach label in close proximity to edge of metal surface for optimum read range performance, as shown in image below.

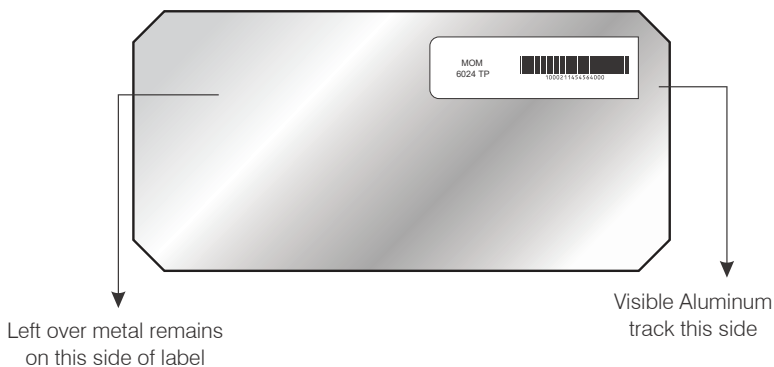

- Ensure the application surface is not uneven and is clean and dry, to obtain maximum bond strength. If required, use approved cleaning solvents to clean surface.
- Avoid touching the backside of the label while mounting it

## PERSONALIZATION OPTIONS

### Pre-encoding

- Customer specific encoding of EPC

### Customized Printing

- Customer specific layout including logo, text, numbers, barcodes etc.

## ORDER INFORMATION

### Part Number

- RF.LI.TT.MOM.6024TP.ETSI
- RF.LI.TT.MOM.6024TP.FCC

### Roll Sizes

- 500 Labels per Roll / 4 Rolls per Carton

# RADIATION PATTERN & READ RANGE GRAPH

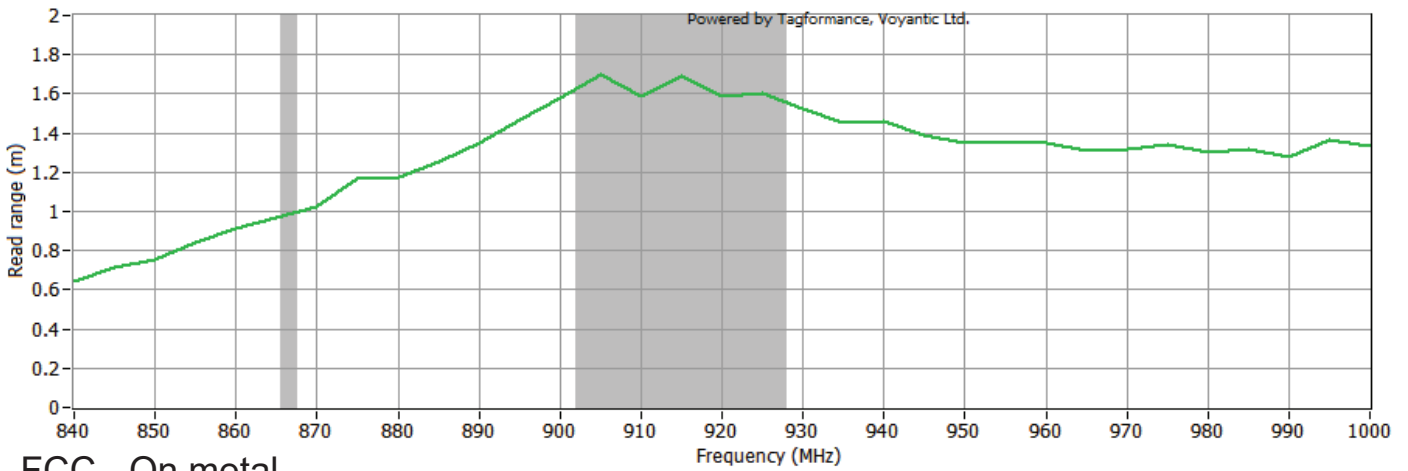
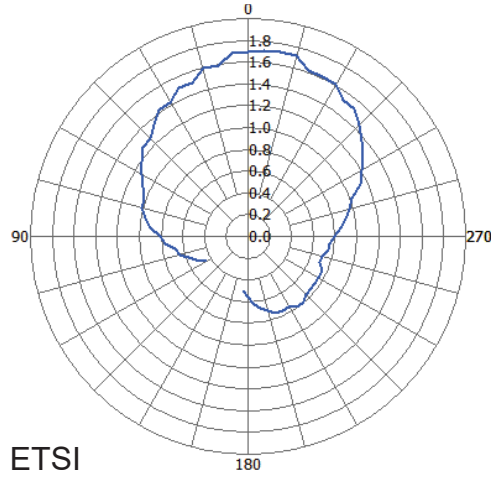
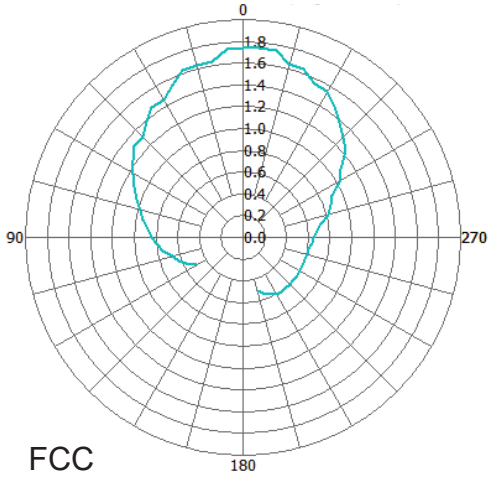

FCC - On metal

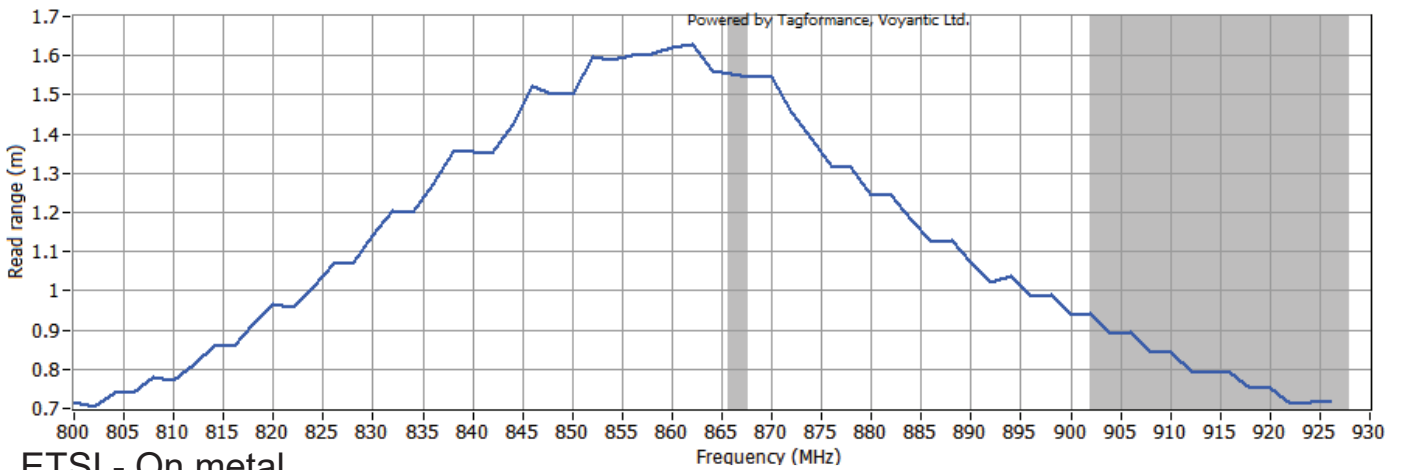

ETSI - On metal

\* Other IC's available on request

\*\* The indicated read range values are measured in our laboratory testing environment, where antennas with optimum directivity are used with maximum allowed operating power. Different surface materials and environments may exhibit different results.



Version : 260719.01