

# **EDISecure<sup>®</sup>** **XID 8600 Retransfer Printer**

## **Instruction Manual**

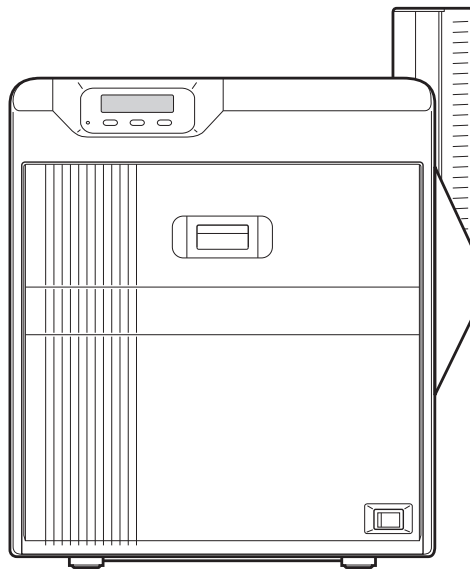

- Thank you for purchasing this product.
- Please read this manual carefully before use to ensure correct operation. It is particularly important to read the “Safety Precautions” in the “READ ME FIRST” for safe operation. After reading, retain this manual carefully for future reference.
- The product number is important for quality control. Upon purchase, check the back of the unit to make sure that the product number is correctly displayed.

#### Notes about this manual

- (1) This manual may not be reprinted in any way without permission.
- (2) The contents of this manual, as well as the specifications and design of this product, may change without notice.
- (3) The illustrations used in this manual may differ slightly from the actual product.

---

## Contents

---

### Before Use

About this Manual .....	3
Precautions .....	3
Disclaimer .....	7
Name and Functions of Parts .....	7
Specifications .....	10
Accessories/Products Sold Separately .....	10
Options .....	11

---

### Operating the Printer

Printing a Card .....	12
Operation Panel .....	13
Setting Mode .....	15
Sequence of Setting Modes .....	17
Factory Settings .....	19
Security Lock .....	20
Setting Using the Operation Panel .....	20

---

### Replacement

Cards .....	29
Ink Ribbon .....	30
Retransfer Film .....	31

---

### Maintenance

Servicing of Parts .....	33
Servicing Based on Print Output .....	41

---

### Troubleshooting

When an Error Message is Displayed .....	42
Cards .....	44
Ink Ribbon .....	52
Retransfer Film .....	54
Unable to Produce Desired Printing Results .....	55
Printer not Operating as Desired .....	56

---

### Setup

Installation and Connection .....	57
Printing Media .....	58
Printer and Computer Connection .....	62

## About this Manual

### Contents of this Manual

- The copyright of this manual belongs to our company. Reprint and duplicate of this manual in part or full without the prior consent of our company is strictly prohibited.
- Product names of other companies described in the manual are the trademarks or registered trademarks of the respective companies. Symbols such as ™, ® and © are omitted in this manual.
- Designs, specifications, or other details described in this manual may be modified for improvement without prior notice.
- Microsoft and Windows are either registered trademarks or trademarks of Microsoft Corporation in the United States and/or other countries. Microsoft® Windows® 8 operating system, Microsoft® Windows® 7 operating system, Microsoft® Windows Vista™ operating system and Microsoft® Windows® XP operating system are represented as Windows 8, Windows 7, Windows Vista and Windows XP respectively in this manual.
- Microsoft product screen shot(s) reprinted with permission from Microsoft Corporation.
- This product includes software developed by the OpenSSL Project for use in the OpenSSL Toolkit. (<http://www.openssl.org/>) This product includes cryptographic software written by Eric Young (eay@cryptsoft.com). This product includes software written by Tim Hudson (tjh@cryptsoft.com).

## Precautions

### Safety Precautions

- Please read through all the following items before using the printer.

### Graphical Symbols

- A number of graphical symbols are used in this manual as well as on the printer. They are intended to ensure the safe use of this product, protect users against safety hazards, as well as prevent damage of property. Make sure that you read through this manual after gaining a proper understanding of the symbols' meaning.



- If you ignore the warning with this mark, and handle the unit in a wrong way, death or serious injuries may occur.



- If you ignore the caution with this mark, and handle the unit in a wrong way, injuries or damages to properties may occur.

### Warnings



■ **If the abnormal phenomena as listed below are seen, immediately stop operating the unit. Continuing operation may cause a fire or electric shock.**

- Smoke or odd smell comes out from the machine.
- Water or metal went into the machine.
- The unit fell to the floor, or the cabinet was broken.
- The power cable is damaged (exposed lead, broken cable, etc.)

If you see these phenomena, turn off the power, pull out the power plug, and contact your dealer as soon as possible. Do not try to repair it by yourself. It is dangerous.

■ **Do not remove the screws, or disassemble or alter the machine.**

- High-voltage components are contained in the unit. Touching these areas may result in an electric shock.
- Ask your dealer if you want your printer inspected or repaired.
- Do not remove the external covers of the machine. You may get an electric shock.

■ **Do not work on the power cable, or give excessive force on it. Do not put heavy objects such as furniture on the cable.**

- The cable may be damaged, causing a fire or electric shock.
- When you find a defect on the power cable, such as exposed lead, stop using the unit, and consult your dealer.

■ **Do not use the machine with the power plug inserted incompletely.**

- The machine generates heat due to incomplete contact, causing a fire or electric shock.
- Do not put many cords on a single plug socket. The power cords also heats up.

■ **Do not use the machine with dusts piled on the power plug. Do not put a metallic material adjacent to the power plug.**

- Dusts and metal are conductive, causing a fire or electric shock.
- Pull out the power plug from the outlet every six months, and clean the dusts piled on the legs and body of the plug.

■ **Do not use a line voltage other than instructed.**

- Using a line voltage or power supply which is not specified may cause a fire or electric shock.

■ **Do not put foreign materials from the openings of the machine (e.g., vents, card slots, cassette inlet, etc.)**

- Metals, flammable things, and other foreign materials may cause a fire or electric shock if entering into the machine.

- If these things went into the machine, immediately turn off the power, pull out the power plug, and ask your dealer to repair. Do not try to repair it by yourself. It is dangerous.

■ **Do not put a container with liquid in it, or small metal ornaments and the like on the machine.**

- The liquid or metal entering into the machine acts as a conductor, causing a fire or electric shock.

- If liquid or metal went into the machine, immediately turn off the power, pull out the power plug, and ask your dealer to repair. Do not try to repair it by yourself. It is dangerous.

■ **Do not place the machine on a rickety table or slanting places.**

- The machine may fall out of the table or fall over, which may damage the machine or injure you.

- If the machine is damaged by falling or turnover, immediately turn off the power, pull out the power plug, and ask your dealer to repair. Do not try to repair it by yourself. It is dangerous.

■ **Do not wet the machine with water.**

- Using the machine at a place where water splashes on the machine, or wetting the machine with water (applying, throwing, or spilling water over the machine) may cause a fire or electric shock.

- If water entered into the machine, immediately turn off the power, pull out the power plug, and ask your dealer to repair. Do not try to repair it by yourself. It is dangerous.

■ **Do not touch the machine with wet hands.**

- Touching the machine with wet hands may cause an electric shock.

■ **Do not use the printer when cards are jammed inside.**

- Cards may not be discharged correctly such as when the retransfer setting for the card is inappropriate. Stop using and remove the jammed cards immediately. Otherwise, you may have problems removing the cards, and fire or electric shock may also occur as a result.

■ **Do not touch the power plug during electrical storms.**

- Lightning may cause an electric shock.

■ **Ground the machine with the attached electric cord when connecting it to the utility outlet.**

- Using a cord other than the one supplied for grounding may cause an electric shock when the machine fails.

■ **Do not put your head or yourself into the packaging bag.**

- Do not play with the packaging bag. You may suffocate yourself.

- Give close attention to small children who may want to play with the packaging bag.

■ **Do not use the machine while it has a fault.**

- Do not use the machine while it has a fault, as this may cause a fire or electric shock.

- Immediately turn off the power, pull out the power plug, and ask your dealer to repair. Do not try to repair it by yourself. It is dangerous.

■ **Keep the mounting part of a cardiac pacemaker away from the machine.**

- Radio waves used by the RF-ID function inside the printer system may affect the operation of the cardiac pacemaker.

## Caution



■ **Pull out the power plug before cleaning the machine.**

- This is for preventing electric shocks.

■ **Pull out the power plug when you won't use the machine for a prolonged period of time to assure safety.**

- Remove the power plug from the outlet for safety when you won't use the machine for a long time.

■ **Do not move the machine with the power cable and other electric cables connected.**

- The cables may be damaged while being moved, which may cause a fire or electric shock.
- You may stumble over the cable and get injured.

■ **Do not move the machine with objects placed on it.**

- They may fall on you and hurt you.

■ **Do not put heavy objects on the machine.**

- They may fall on you and hurt you.

■ **Do not block the vents.**

- Heat generated inside the machine cannot escape, which may cause a fire.

■ **Do not rest your body on the machine, or leave it suspended above the ground.**

- The machine may drop, causing damage or injury. Pay particular attention when there are young children around.

■ **Be sure to work with two persons when you unpack, move or lift the machine.**

- If you work alone, you may be injured by the fallen machine or hurt your back by lifting a heavy machine by yourself.

■ **Inspection**

- Ask your dealer or a qualified person to inspect the machine, typically once every two to three years. Operating the machine with dusts piling on the components for a prolonged period of time may cause a fire or a malfunction of the machine. It will be particularly effective to inspect the machine before wet rainy season. Consult your dealer on the costs of inspection.

■ **Do not place the machine in the following locations.**

Doing so may cause fire or electric shock.

- Places that are highly humid or dusty.
- Places that are exposed to oily smoke or steam, such as near a cooking table or humidifier.
- Places near a heating equipment.
- Places that are subject to water droplet condensation, such as beside a window.

Also, placing it at a place that is exposed to direct sunlight may result in deterioration of the cabinet.

■ **Hold the body of the power plug when pulling it out.**

- Do not pull out the plug by holding the cable. The cable may be broken or damaged which may in turn cause a fire or electric shock.

■ **Do not touch the power plug with a wet hand**

- You may get an electric shock.

■ **Do not lay the power cable near the heating equipment.**

- The covering of the cable will melt due to heat from such equipment, which may cause a fire or electric shock.

■ **The heat rollers and adjacent areas become hot during operation.**

- Be careful not to touch the heat rollers and adjacent areas when replacing the ink ribbon or retransfer film, or remove jammed cards.
- Wait until the heat rollers get cooled down to prevent burns.

■ **Be careful not to catch your fingers in the card bracket of the card hopper, printer door and others.**

- Do not catch your fingers when replenishing the cards, attaching the ink ribbon and retransfer film, or when removing the card from the card hopper. It may cause injury.

■ **Be sure to use the power cord supplied with this printer.**

- Using a power cord that is of a different voltage or a damaged power cord will result in fire or electric shock.

■ **The power cord should be used only with this printer.**

- Do not use the power cord with products other than this printer. Doing so may result in fire or electric shock.

■ **When installing or moving the printer, hold the bottom (handle) of the printer with one hand on each side.**

- Carrying the printer by its corners or front and back may result in catching your fingers in between the printer and the floor or table.

### Precautions During Use

- Please read through all the following items before using the printer.

### Printer Installation

- When the printer is not in use, it is recommended that you turn off the power, and use a cover that is large enough to cover up the entire printer unit.
- Do not place the printer unit in the following locations. Doing so may have adverse effects on the printer.
  - Carpeted room.
  - Places with a busy flow of people.
  - Places where paper (corrugated boards, etc.) is handled or stored.
  - Places near photocopiers.
  - Places exposed to direct sunlight or near a heating equipment (such as a stove).
  - Inclined or unstable surfaces.
  - Places exposed directly to cold air, such as near an air-conditioner outlet, or places subject to high temperatures.
- When installing the printer, ensure there is sufficient space around the printer. (Install the printer by allowing a clearance of at least 20 cm between its sides and surrounding walls. Allow a clearance of at least 10 cm between the rear of the printer and the wall.)
- When installing or moving the printer, hold the bottom (handle) of the printer with one hand on each side to avoid jamming your hands or fingers.

#### ■ Canceling the transport mode

- While in the transport mode during installation, the retransfer film cannot be loaded. If the printer is turned on without loading the retransfer film, a [Film Search] message appears and the transport mode is canceled.

#### ■ During transport or moving of the printer

- Make sure to set to the transport mode.  
"Transport Mode Setting" (☞ page 27)

### Precautions on Retransfer Film/Ink Ribbon/Card

#### ■ Handling instructions

Pay careful attention of the following when handling a printing media (retransfer film or ink ribbon) or card.

- Using a deformed or scratched card may cause card feed errors.
- Touching the printing surface of the printing media or card directly with your hand may cause the print to turn out uneven.
- Foreign particles attached to the printed areas may result in printing voids. Install the printing media or card in a clean environment.
- Use of electrically-charged printing media or cards may cause printing errors. Do not allow static to occur, such as due to cards rubbing against each other.
- When replacing or replenishing a printing media or card that is stored under a low temperature, use after leaving the media or card in the operating ambient temperature of the printer for at least one hour. Otherwise, condensation may occur, causing printing errors or malfunction of the printer.

#### ■ Storage instructions

- The storage conditions of the printing media (retransfer film or ink ribbon) and card have a significant effect on the printing quality. Store the printing media or card in one of the following locations.

#### ■ Storage environment

- Temperature: 5 °C to 25 °C
- Relative humidity: 40 % to 60 %

#### ■ Storage location

Do not store the printing media or card in the following locations. Doing so may cause the media or card to deteriorate.

- Places exposed to direct sunlight.
- Places with a high temperature and humidity.
- Places near organic solvents or diazo copiers.

#### ■ Storage period

- Use the printing media (retransfer film or ink ribbon) within half a year after purchase. For details on the cards, please consult our authorized dealers.

### Precautions on Retransfer Film/Ink Ribbon

- Put on the supplied gloves when handling the retransfer film/ink ribbon. Direct contact of your hand with the printing surface may result in printing errors.

#### ■ When retransfer film/ink ribbon is dismantled

- Winding misalignment may occur. If an improperly wound retransfer film/ink ribbon is loaded, printing failure or error may occur.

#### ■ When loading the retransfer film/ink ribbon

- Use your hands to adjust the media at the supply and take-up sides so that they are parallel to each other. When doing so, make sure you do not touch the printing surface.
- Refer to the label adhered to the cassette for alignment of the image position. Printing errors may occur if the position is not properly aligned.

Winding misalignment

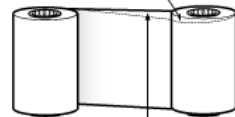

Adjust the position with your hands so that the media position is parallel at the take-up and supply sides

### Precautions on Cards

- Put on the supplied gloves when handling the cards. Direct contact of your hand with the printing surface of the card may result in printing errors.

#### ■ Handling and storage of cards after printing

Avoid storing cards at places that are exposed to direct sunlight or subject to high temperature and humidity.

Discoloration or fading may occur if a card comes into contact with the following chemicals or stationery.

- Organic solvents, including alcohol, film cleaner, and diazo copies.
- Files, document cases, pass holders, or erasers made of flexible polyvinyl chloride.
- Hair wax or cosmetic products.

#### ■ Card types

Thin cards and certain card materials may not be suitable for printing using this printer. For details on the card material to use and other specifications, please consult our authorized dealers in advance.

#### ■ When a card is jammed inside the printer

Cards may not be discharged correctly such as when the retransfer setting for the card is inappropriate.

Stop using and remove the jammed cards immediately. Otherwise, you may have problems removing the cards, and fire or electric shock may also occur as a result.

- When a card is jammed, remove it according to the procedure described in the Instruction Manual.
- If the card cannot be removed, do not try to do so forcibly. Consult our authorized dealers or the servicing personnel.

#### ■ Cautions:

- If the card thickness of card hopper is not properly adjusted, printing error or printer malfunction may occur. Please adjust thickness in accordance with the card which will be used.

"Adjusting card thickness" (☞ page 61)

---

## Disclaimer

■ We do not provide compensation for any malfunction during card printing caused by breakdown of the machine, ink ribbon defects or card characteristics. In addition, we also do not provide compensation for insufficient print quality as a general rule. Please evaluate carefully beforehand.

### ■ Card Material

Some card material may not be suitable for printing. Using a contact-type IC card other than those specified by the dealer, may cause damage to the thermal head. No compensation is made for the life reduction and failures that were caused by unsuitable card material. Warp of card or uneven thickness of IC cards, even though they are within the tolerance of JIS or ISO standards, may not be suitable for printing or feeding. For details on the specifications about card material or others, consult the dealer in advance

### ■ Version upgrade

The following defects may occur as a result of the version upgrade for the firmware of the printer or for the printer driver.

- Card printing is disabled for the application software that has been used.
- The operation of the printer or application software becomes unstable.
- Defects in print result occurs.
- Print color or shade differs.
- The performance of reproducing fine letters, changes.
- Others

Be sure to retain a copy of the current version when performing version upgrade. Reinstall the previous version immediately if these problems occur. We are not liable for any damage such as defective cards or interruptions during printing as a result of the version upgrade.

## Name and Functions of Parts

### Internal Mechanism Diagram

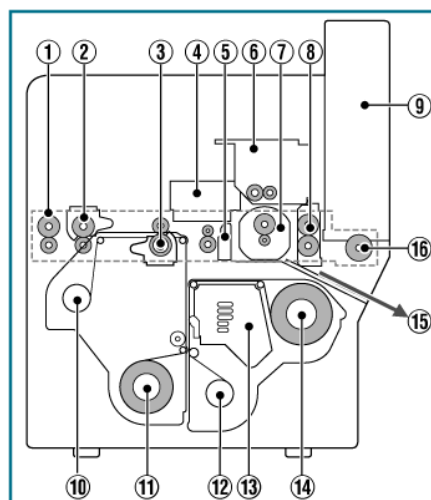

- ① Card feeder unit
  - This is the roller for feeding cards.
- ② Bend remedy unit (optional)
  - Corrects bending of the card after retransfer.
- ③ Retransfer heating roller
  - Transfers images printed on the retransfer film to the card.
- ④ Non-contact IC encoder (optional)
  - Writes data to a non-contact IC card.
- ⑤ Contact section of contact IC encoder (optional)
  - Writes data to a contact IC card.
- ⑥ Magnetic encoder (optional)
  - Writes data to a magnetic stripe card.
- ⑦ Card turn over unit (double-sided printer only)
  - Inverts the card.
- ⑧ Cleaning roller
  - Removes dust or dirt attached to the card.
- ⑨ Card hopper
  - For loading cards.
- ⑩ Retransfer film (take-up side)
  - For attaching the take-up side of the retransfer film.
- ⑪ Retransfer film (supply side)
  - For attaching the unused side of the retransfer film.
- ⑫ Ink ribbon (take-up side)
  - For attaching the take-up side of the ink ribbon.
- ⑬ Thermal head
  - Prints images on the retransfer film.
- ⑭ Ink ribbon (supply side)
  - For attaching the unused side of the ink ribbon.
- ⑮ NG card outlet
  - Discharges NG cards, such as during card jams.
- ⑯ Card load roller
  - Roller for loading cards.

Front

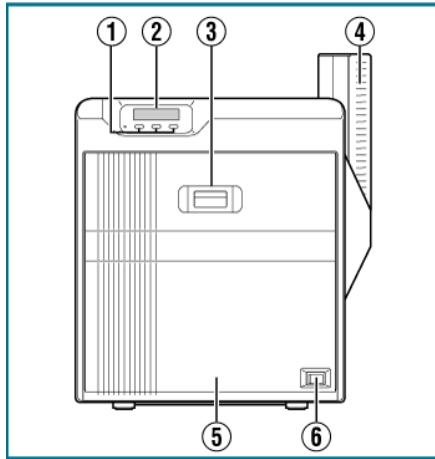

- ① Operation buttons
  - For selecting and confirming information on the operation panel.
- ② Operation panel
  - Displays the settings, operating status, and error messages.
- ③ Sliding knob
  - Opens/closes the printer door.
  - Slide it upward, and pull toward you to open the printer door.
- ④ Card hopper
  - For loading cards.
- ⑤ Printer door
  - Turns the power On/Off.
- ⑥ Power switch

Right

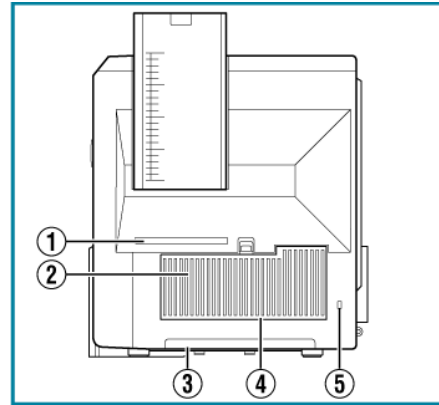

- ① NG card outlet
  - If a card is left inside the printer when the power is turned on or reset, the card will be automatically discharged.
  - Cards in the printer are discharged when an error occurs in the magnetic stripe card or IC card.
- ② Air suction fan opening
  - Air inlet of the internal cooling fan.
- ③ Handle
  - Hold this area when moving the printer.
- ④ Filter cover
  - Cover of the fan filter.
- ⑤ Security slot
  - An anti-theft device that supports Kensington locks can be installed.

Rear

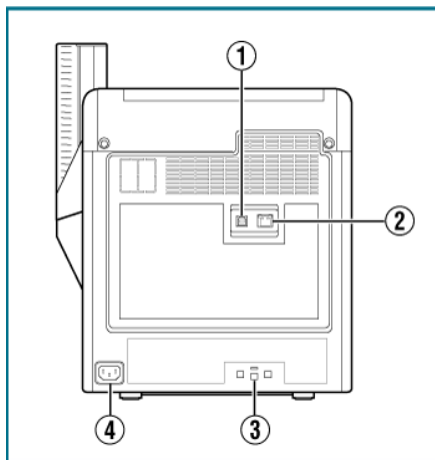

- ① USB cable connection terminal
  - For connecting a USB 2.0 interface cable.
- ② LAN cable connection terminal
  - For connecting a LAN cable.
- ③ Cable clamp
  - For securing the supplied USB cable.
- "Connection" (☞ page 62)
- ④ AC inlet
  - For connecting the power cord.

Left

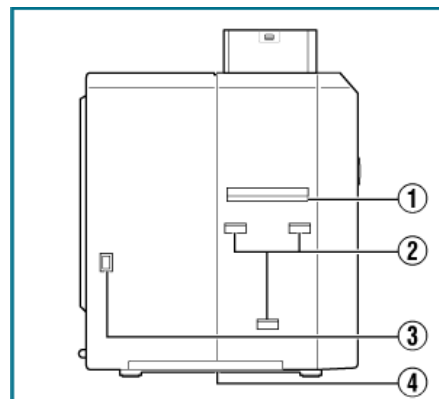

- ① Card outlet
  - Outlet for discharging the cards.
- ② Card stacker (supplied) attachment slot
  - For installing the supplied card stacker.
- ③ Infrared window
  - Sends or receives data via infrared communication by connecting with an external unit.
- ④ Handle
  - Hold this area when moving the printer.



### When Printer Door is Open

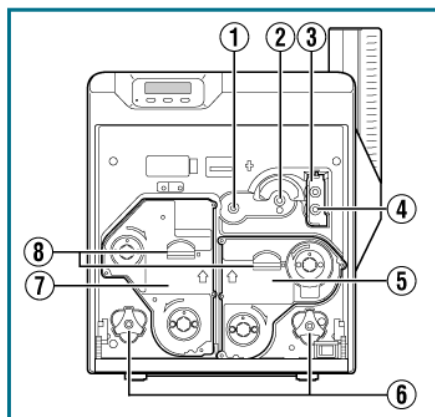

- ① Card feed roller shaft
  - When a card jam occurs, attach a jog dial to turn the card feed roller.
- ② Card turn over unit shaft
  - When a card jam occurs, attach a jog dial to turn the card turn over unit.
- ③ Cleaning unit
  - Removes dust or dirt attached to the card.
- ④ Cleaning roller shaft
  - When a card jam occurs, attach a jog dial to turn the cleaning roller.
- ⑤ Ink ribbon cassette
  - For installing the ink ribbon.
- ⑥ Jog dials
  - For removing jammed cards by turning it after it is detached from the printer unit and attached to the shaft.
- ⑦ Retransfer film cassette
  - For installing the retransfer film.
- ⑧ Cassette buttons
  - Press these buttons in order to pull out the ink ribbon cassette or retransfer film cassette.

### Retransfer Film Cassette

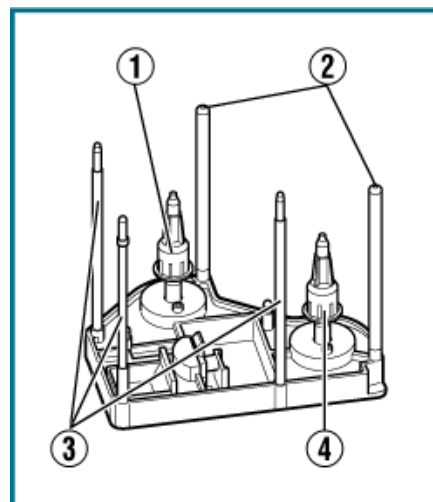

- ① Bobbin holder (black)
  - For securing the take-up side of the retransfer film.
- ② Guide shaft
  - Provides guide to the position for installing the cassette.
- ③ Shafts
  - For installing the retransfer film.
- ④ Bobbin holder (green)
  - For securing the unused side of the retransfer film.

### Ink Ribbon Cassette

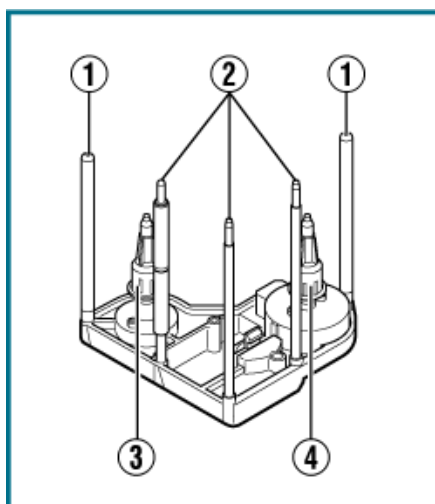

- ① Guide shaft
  - Provides guide to the position for installing the cassette.
- ② Shafts
  - For installing the ink ribbon.
- ③ Bobbin holder (black)
  - For securing the take-up side of the ink ribbon.
- ④ Bobbin holder (yellow)
  - For securing the unused side of the ink ribbon.

## Specifications

### Main Specifications

Item	Description
Recording system	Dye sublimation retransfer
Paper feed mode	Automatic
Recording density	600 dpi
Reproduction gradation	256 levels each for Y, M and C 2 levels for Resin K
Interface	USB2.0(Hi-speed/Full Speed) Ethernet(100BASE-TX/10BASE-T)
Operating environment conditions	Temperature: 15 °C to 30 °C (When peel-off ink, UV ink is used: 17 °C to 28 °C) Humidity: 35 % to 70 % No condensation (When peel-off ink, UV ink is used: 35 % to 60 %)
Storage environment conditions	<Printer unit> Temperature: -15 °C to 55 °C Humidity: 20 % to 80 % <Printing media (retansfer film or ink ribbon) / card> Temperature: 5 °C to 25 °C Humidity: 40 % to 60 %
Power supply	AC 100 V - 120 V, 50 Hz/60 Hz AC 220 V - 240 V, 50 Hz/60 Hz
Current consumption	3.5 A (100 V system) 1.6 A (200 V system)
Power consumption	310 W (maximum power when all options are installed)
Mass	approx. 14.6 kg (double-sided printer, excluding optional built-in items)
Dimensions	343 mm x 411 mm x 322 mm (W x H x D)

### Outline Dimensional Drawing

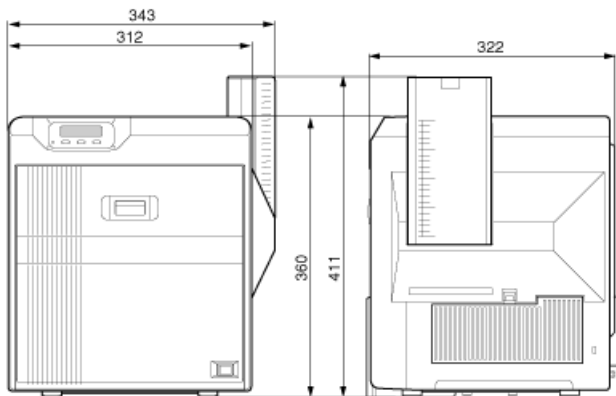

\*The specifications and appearance of this product may be modified for improvement without prior notice.

## Accessories/Products Sold Separately

### Accessories

Please check to ensure that the printer accessories are in place when unpacking the product package.

- CD-ROM x 1
- Getting started guide x 1
- "READ ME FIRST"(LST1013) x 1
- Power Cord (2 m) x 2
- Cleaning Card x 1
- Card Stacker x 1
- USB 2.0 Cable (2 m) x 1
- Gloves x 1
- Tweezers x 1

### Products Sold Separately

To purchase these items, please consult our authorized dealers. Use the retransfer film or ink ribbon within half a year after purchase.

- Ink Ribbon (YMCK), 1,000 frames/roll (Model: DIC10216)
- Ink Ribbon (YMCKK), 750 frames/roll (Model: DIC10217)
- Ink Ribbon (YMCK-PO), 750 frames/roll (Model: DIC10218)
- Ink Ribbon (YMCK-UV), 750 frames/roll (Model: DIC10313)
- ART Retransfer Film, 1,000 frames/roll (Model: DIC10319)
- Cleaning Kit (Model: DIK10044)  
Set incl. 10 print head cleaning swabs, 10 cleaning tissues for rollers and 10 special cleaning cards
- Magnetic Stripe Encoder Head Cleaning Cards (Model: DIC10311)  
Box of 10 cards

## Options

### Options

- Bend remedy unit  
Device for correcting card bend after printing.
- Magnetic encoder  
Device for writing data to a magnetic stripe card.  
It can only be installed on a double-sided printer.
- Contact IC encoder  
Device for writing data to a contact IC card.
- Non-contact IC encoder  
Device for writing data to a non-contact IC card.

## Printing a Card

### Cautions:

- If you see an [Initializing..] or [Preheating..] message on the LCD panel of the printer, this means the printer is not ready yet. Printing cannot be performed until a [Ready] message appears.
- Printing the card on the side with the magnetic stripe may cause printing errors or damage to the card's functions. If you want to do so, please consult our authorized dealers in advance.
- For printing using application software prepared by the user, refer to the instruction manual of the corresponding application.

1 Turn on the power

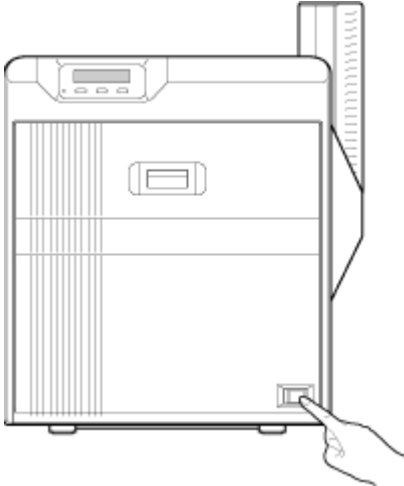

2 Check to ensure that cards are inserted into the card hopper

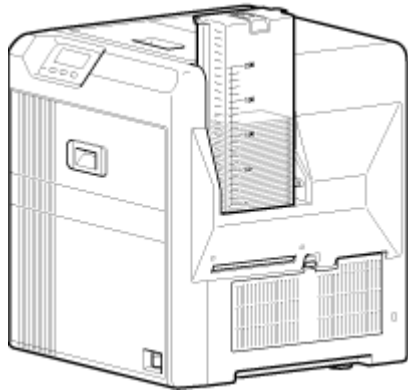

3 Open the application's print settings screen, and select this printer in [Name]

- If there are multiple printers, select the name of the printer that you want to perform printing on.

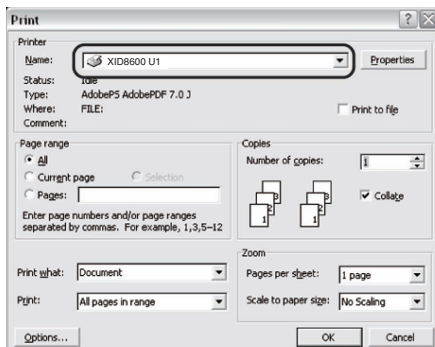

4 After ensuring that a [Ready] message appears on the LCD panel of the printer, start printing

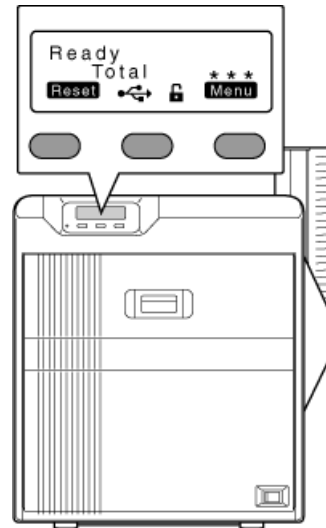

## Operation Panel

### Name and Functions of Parts

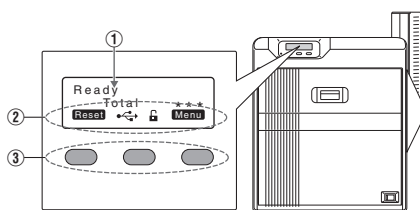

- ① Operation panel
  - Displays the settings, operating status, and error messages.
- ② Status icon/operation button display
  - Displays the status icon and function of the operation button.
- ③ Operation buttons
  - For selecting a button function displayed on the operation panel.

### Operation Buttons

#### ■ Resets the printer.

**Reset**

- Press **Reset** →  in sequence.

#### ■ Enters the setting mode.

**Menu**

#### ■ Exits setting.

Pressing it each time brings you to the setting item on the next higher level.

**Exit**

#### ■ Displays the setting item on the next lower level.

**Enter**

#### ■ Confirms or executes the setting.



#### ■ Pressing it each time displays the next setting item.

**Next**

#### ■ Pressing it each time displays the next setting.



#### ■ Enters the settings change mode.

**Change**

- If **Change** is not displayed for an item, you can adjust the settings on the status monitor of a computer.

#### ■ Enters the scroll mode for the displayed characters.

**Scroll**

#### ■ Scrolls to the next displayed character on the left.



#### ■ Scrolls to the next displayed character on the right.



### Icon Displays on the Operation Panel

#### ■ USB connection

- IP address established

Printer information can be viewed through the network. However, printing is performed through USB connection.



- IP address not established



#### ■ Network connection

- IP address established



- IP address not established



#### ■ Security lock status

- Locked



- Unlocked



## Operation Panel Operation Display

### Background color

Changes according to the printer's operating status.

- During startup  
Bright green
- Under normal circumstances  
Sky blue
- During initialization using **Reset**, during test printing using the operation panel, cleaning and downloading  
Light purple
- During error  
Red

### ■ Starting up

Boot Up..

### ■ Initializing

Initializing..

### ■ Preheating

Preheating..

### ■ Ready

Ready

### ■ Feeding card or discharging NG card

Moving..

### ■ Printing

Printing..

### ■ Test print in progress

Testing..

### ■ Loading card

Loading..

### ■ Downloading

Downloading..

### ■ Magnetic encoding in progress

MG Encoding..

### ■ IC encoding

IC Encoding..

### ■ Adjusting heating roller to the preset temperature

Heating..

### ■ Retransferring

Retransfer..

### ■ Cleaning

Cleaning..

### ■ Power Saving mode

Sleeping..

## Setting Mode

- Settings can be viewed on the printer's operation panel.
- Settings can be changed on the status monitor of the computer.

"Setting Using the Operation Panel" (☞ page 20)

"Sequence of Setting Modes" (☞ page 17)

"Factory Settings" (☞ page 19)

## Cleaning

- For setting during cleaning of the card feed roller, heating roller or magnetic head.

"Card Feed Roller/Heating Roller" (☞ page 35)

"Magnetic Head" (☞ page 37)

### Settings

- Rollers

Select this value when cleaning the card feed roller or heating roller.

- MG

Select this value when cleaning the magnetic head.

## Counter Reset

- This is used to reset the free counter and error counter.

"Counter Reset" (☞ page 25)

## Test Print

- Prints the printer's built-in test pattern, or the different settings.

"Test Print" (☞ page 22)

### Settings

- Test Print: Test Pattern, Printer Setting, Network Setting, Lami Setting

## Download

- Updates the firmware.

"Firmware Update" (☞ page 22)

## Transport Mode

- For setting the transport mode.

"Transport Mode Setting" (☞ page 27)

## Media

- Displays the settings of the printing media.

### Settings

- Ink Type: YMCK, YMCKPO, YMCKK, YMCKUV

Displays the ink ribbon type.

- Film Type: 1000, 750

Set according to the type of retransfer film.

- Card Thickness: Standard, Thin

Set according to the thickness of the card.

Standard: Supports card thickness of 0.76 mm

Thin: Supports card thickness of 0.25 mm

## Print

- Displays the printing settings.

### Settings

- YMC Level: -3, -2, -1, 0, 1, 2, 3

For setting the YMC (color) density level.

Selecting a larger value increases the density level.

- Black Level: -3, -2, -1, 0, 1, 2, 3

For setting the K (black) density level.

Selecting a larger value increases the density level.

- Black Mode: Standard, Fine

For setting the printing mode for the K (black) component.

If the characters still appear faded after raising the [Black Level], set to [Fine]. However, printing time required will be longer than the [Standard] setting.

- UV Level: -3, -2, -1, 0, 1, 2, 3

For setting the UV ink density level.

Selecting a larger value increases the density level.

During UV printing, card bend may increase if the card has a low heat resistance or in an environment with high temperature.

- PO Level: -3, -2, -1, 0, 1, 2, 3

For setting the density level of the peel-off ink.

Selecting a larger value increases the density level.

## Retransfer

- Displays the retransfer mode settings.

### Settings

- Temp Level: -2, -1, 0, 1, 2

For setting the retransfer heating roller temperature.

Selecting a larger value increases the temperature.

Retransfer may fail depending on the card used. If retransfer fails, raise the setting to the next higher value.

A higher retransfer heating roller temperature helps to enhance the card retransfer performance, but the stronger heat may cause the card to deform more.

If the printer is not reset after changing the temperature setting, temperature is adjusted after the printing operation starts.

- Speed (Front): -3, -2, -1, 0, 1, 2

For setting the front side retransfer speed.

Selecting a larger value increases the speed.

Retransfer may not be successful on some parts of the card depending on the card used. Lowering the setting value helps to enhance the retransfer performance, but the stronger heat may cause the card to deform more.

- Speed (F-UV): -3, -2, -1, 0, 1, 2

For setting the retransfer speed of the second panel on the front side during UV ink printing of retransfer films in two panels. Selecting a larger value increases the speed.

- Speed (Back): -3, -2, -1, 0, 1, 2

For setting the back side retransfer speed.

Selecting a larger value increases the speed.

Some types of cards may bend during double-sided printing. If card bend occurs, raise the back side retransfer speed to one level higher than the front side retransfer speed setting.

- Speed (B-UV): -3, -2, -1, 0, 1, 2

For setting the retransfer speed of the second panel on the back side during UV ink printing of retransfer films in two panels. Selecting a larger value increases the speed.

- MG Peel Mode: Standard, MG Stripe

For setting the method for peeling the retransfer film.

Retransfer at areas close to the magnetic stripe may not be performed correctly for some card types. When a magnetic stripe card is used, this problem may be remedied by setting to [MG Stripe].

- Standby Mode: Front wait, Back wait

During double-sided printing by connecting to a laminator, retransfer remains in the standby state until the laminator is in the [Ready] mode. Select whether to standby using the front or back side.

- Backside Cool: On, Off

For setting the time interval for cooling the card before performing retransfer on the back side during double-sided printing. Setting this to [On] may help to reduce card bend.

## Bend Remedy

- Displays the bend remedy mode settings.

### Settings

- Temp Level: -5, -4, -3, -2, -1, 0, Off

For setting the bend remedy heating roller temperature.

Selecting a larger value increases the temperature.

If the printer is not reset after changing the temperature setting, temperature is adjusted after the printing operation starts.

- Speed: -2, -1, 0, 1, 2

For setting the bend remedy speed.

Selecting a larger value increases the speed.

## Heat Roller

- Displays the settings of the Power Saving mode or HR Control mode.

### Settings

- Power Saving: 5, 10, 15, 20, 25, 30, 45, 60, Off (unit: minutes)

For setting the time for the Power Saving mode.

While in the [Ready] mode, if the printer is not operated for a specific time interval, the retransfer heating roller, bend remedy heating roller, and backlight of the operation panel will turn off automatically to save power.

While in the Power Saving mode, [Sleeping..] is displayed.

To cancel the setting temporarily using the operation panel, press

**Reset** →  to reset the printer.

- HR Control: Off, On

For setting whether to standby the printer by lowering the retransfer heating roller temperature if cards are not printed for 30 minutes or longer.

The printer will automatically be restored to the original mode during the next card printing, but it may take a longer time before the first card is printed.

## Setting

- Displays the printer settings.
- Setting can also be performed using the printer's operation panel.

### Settings

- Display:

Mode: Counter, Laminator State

This is used for setting the information to be displayed on the operation panel.

"Display Mode Setting" (☞ page 23)

Counter: Total Cnt, Head Cnt, Free Cnt, Cleaning Cnt, Error Cnt

This is used for setting the type of counter displayed on the operation panel.

"Counter Setting" (☞ page 24)

Contrast: -3, -2, -1, 0, 1, 2, 3

For setting the contrast of the operation panel display.

"Contrast Setting" (☞ page 25)

- Buzzer: On, Off

For setting whether to sound the buzzer when an error occurs or when settings are changed.

"Buzzer Setting" (☞ page 26)

- Unit No.: No.1 - No.10

For setting the printer's unit number according to the USB environment.

"Unit Number Setting" (☞ page 27)

## Option

- Displays the optional settings.

### Settings

- MG: None, ISO

Displays the availability of a magnetic encoder or the type of magnetic encoder used.

- IC Antenna: None, Installed

Displays the availability of a non-contact IC encoder.

- IC Contact: None, ISO Type

Displays the availability of a contact IC encoder (contact section) or the type of IC encoder used.

- Contact IC R/W: None, Installed

Displays the availability of a contact IC R/W.

- Bend Remedy HR: None, Installed

Displays the availability of a bend remedy unit.

- Turn Over: None, Installed

Displays the availability of a card turn over unit.

## MG

- Displays the magnetic encoder settings.

### Settings

- ISO Type: Loco, Hico

For setting the coercivity when writing data to an ISO magnetic stripe card.

- Retry Count: 0, 1, 2, 3

For setting the maximum number of retries when writing to or reading of the magnetic stripe fails.

## Network

- Displays the network settings.

### Settings

- Printer Name: ASCII character strings (10 characters)

For setting the printer name.

- Host IF: LAN, USB

For setting the interface.

If the printer is connected via USB interface, the setting switches automatically to USB when initialization starts even if the LAN setting is selected.

- IPv4:

DHCP: On, Off

Setting: IP Address, Subnet Mask, Gateway

Effective IP: IP Address

For setting IPv4.

- IPv6:

Adrs Config: Auto, Manual

Setting: IP Address, Prefix Len, Gateway

Effective IP: IP Address1, IP Address2, IP Address3

For setting IPv6.

- Session Time Out: Off, 10 min, 20 min, 30 min, 60 min

For setting the session timeout interval.

- MAC Address: Hexadecimal character strings

Displays the MAC address.

- IPsec Mode: Off, On

For setting the availability of IPsec.

- IPsec Type: not Setting, Preshard, Certificate

Displays the method of IPsec authentication.



### Sequence of Setting Modes

- Settings can be viewed on the printer's operation panel.
  - Settings can be changed on the status monitor of the computer.
- "Setting mode" (page 15)

1 Press **Menu**

- Enters the setting mode.

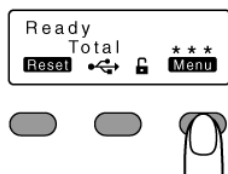

2 Press **Next**

- Pressing it each time displays the next setting item.
- Pressing **Enter** displays the setting item on the next lower level.
- Pressing **Change** enters the settings change mode.
- Pressing **←** confirms or executes the setting.
- Pressing **Exit** displays the setting item on the next higher level.

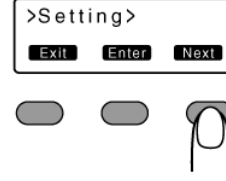
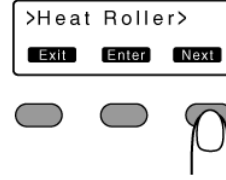
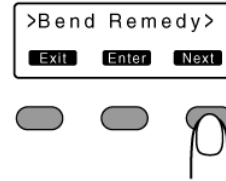
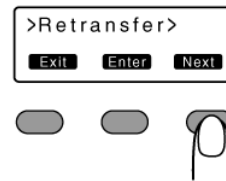
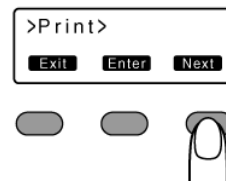
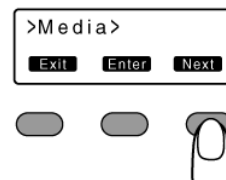
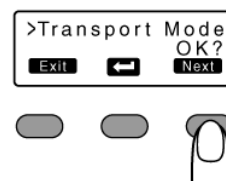
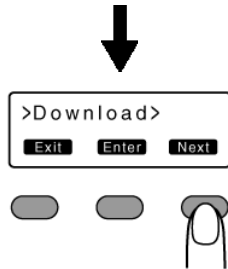
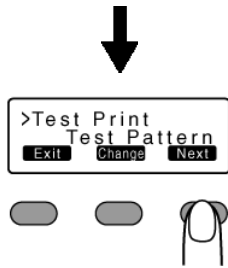
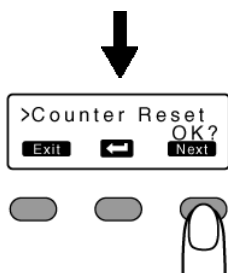
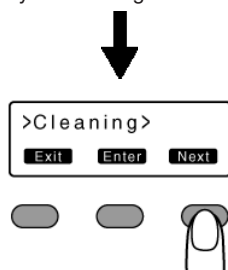

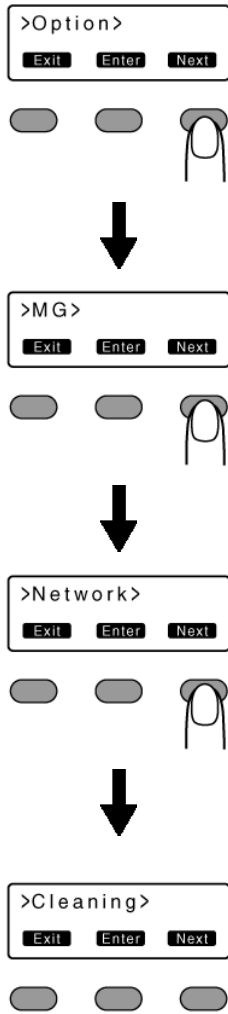

**Factory Settings**

■ **Media**

Item	Factory Settings
Ink Type	-
Film Type	1000
Card Thickness	Standard

■ **Print**

Item	Factory Settings
YMC Level	0
Black Level	0
Black Mode	Standard
UV Level	3
PO Level	0

■ **Retransfer**

Item	Factory Settings
Temp Level	1
Speed (Front)	2
Speed (F-UV)	2
Speed (Back)	2
Speed (B-UV)	2
MG Peel Mode	Standard
Standby Mode	Front Wait
Backside Cool	Off

■ **Bend Remedy**

Item	Factory Settings
Temp Level	Off
Speed	2

■ **Heat Roller**

Item	Factory Settings
Power Saving	Off
HR Control	Off

■ **Setting**

Item	Factory Settings	
Display	Mode	Laminator State
	Counter	Total Cnt
	Contrast	0
Buzzer	On	
Unit No.	No.1	

■ **MG**

Item	Factory Settings
ISO Type	Hico
Retry Count	1

■ **Network**

Item		Factory Settings	
Printer Name		PRINTER01	
Host IF		LAN	
IPv4	DHCP		On
	Setting	IP Address	192.168.0.141
		Subnet Mask	255.255.255.0
		Gateway	192.168.0.1
	Effective IP	IP Address	-
IPv6	Adrs Config		Auto
	Setting	IP Address	None
		Prefix Len	64
		Gateway	None
	Effective IP	IP Address 1	-
		IP Address 2	-
		IP Address 3	-
Session Time Out		Off	
Mac Address		-	
IPSec Mode		Off	
IPSec Type		not Setting	

### Security Lock

- The security lock function can be applied to the printer door and card hopper to prevent opening of the printer door as well as removal of cards.
- The lock can be turned on/off using the status monitor on the computer.

### Setting Using the Operation Panel

#### Initialization

- Whenever the power is turned on, cue (initialization) is performed automatically on the ink ribbon and retransfer film.
- You can also perform initialization manually using the operation button on the operation panel.

1 Press **Reset**

- An [Initialize OK?] message appears.

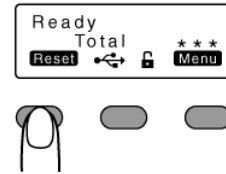

2 Press **←**

- An [Initializing..] message appears, and initialization of the printer starts.

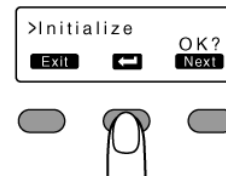

## Initializing Printer When Installing the Cassette

### Memo:

- When detaching the ink ribbon cassette or retransfer film cassette from the printer body, dust may adhere to the ink ribbon or retransfer film. Errors such as discoloring may occur depending on the size of the dust particles. To avoid these problems, it is recommended that you forward by one or two images after installing the cassette.

1 Press **Reset**

- An [Initialize OK?] message appears.

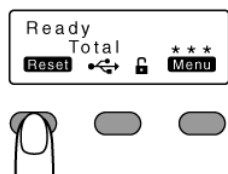

### Initializing printer without feeding the image

1 Press **Left Arrow**

- An [Initializing..] message appears, and initialization of the printer starts.

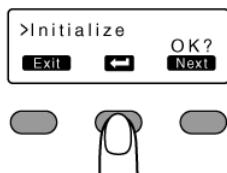

### Initializing printer after feeding by one image

1 Press **Next** to set to [Next Panel, OK?]

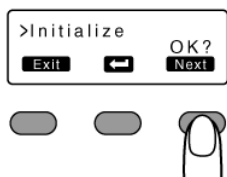

2 Press **Left Arrow**

- An [Initializing..] message appears, and the printer is initialized after feeding the ink ribbon and retransfer film by one image.

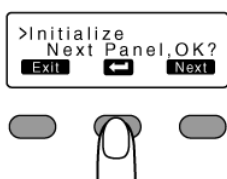

### Initializing printer after feeding by two images

1 Press **Next** to set to [2'nd Panel, OK?]

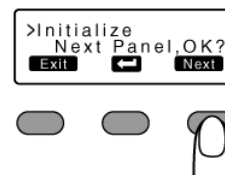

2 Press **Left Arrow**

- An [Initializing..] message appears, and the printer is initialized after feeding the ink ribbon and retransfer film by two images.

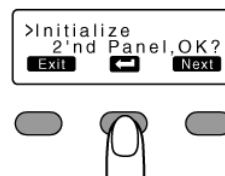

## Test Print

- Prints the printer's built-in test pattern, or the different settings.
- The printer unit can be made to run alone when a system error occurs by separating the computer from the printer.

### Test Pattern Types

- **Test Pattern:**  
Prints standard color pattern on a single side of a card.
- **Printer Setting:**  
Prints the printer settings.
- **Network Setting:**  
Prints the network settings.
- **Lami Setting:**  
Prints the laminator settings.

1 Press **Menu**

- A [Cleaning] message appears.

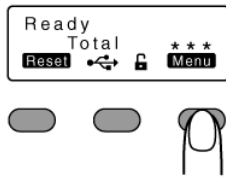

2 Press **Next** to set to [Test Print]

- Pressing it each time displays the next setting item.

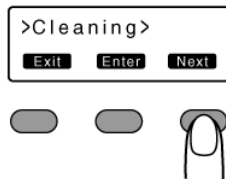

3 Press **Change**

- A test pattern selection screen appears.

4 Press **↓** and select a test pattern type

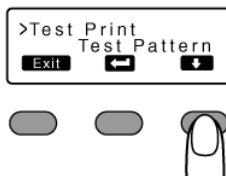

5 Press **↵**

- Test print starts.

## Firmware Update

1 Press **Menu**

- A [Cleaning] message appears.

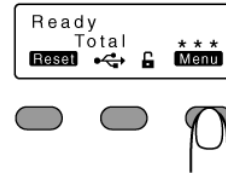

2 Press **Next** to set to [Download]

- Pressing it each time displays the next setting item.

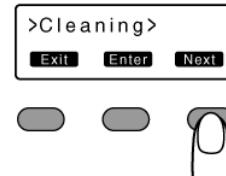

3 Press **Enter**

- A [Download Ready] message appears, indicating that the printer is ready to download data from the computer.

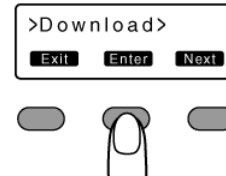

4 Start data download from the computer

- A [Downloading..] message appears.



### Cautions:

- Do not turn off the power during data download from the computer. Doing so may damage the printer firmware and cause malfunction.
- A [Download Ready] message appears when data download from the computer is complete.



5 When [Download Ready] appears, press **Exit**

6 When the [Please Power Off] message appears, turn off the power

- The firmware is updated after the power is turned on again.

■ If download fails and printer cannot be started up

- If download of the printer firmware fails, the printer may not be able to start up when it is rebooted. When this occurs, download the firmware again according to the following procedure.
  - ① Turn on the power while holding down the operation button (center)
  - A [SBP2 Running] message appears, indicating that the printer is ready to download data from the computer.

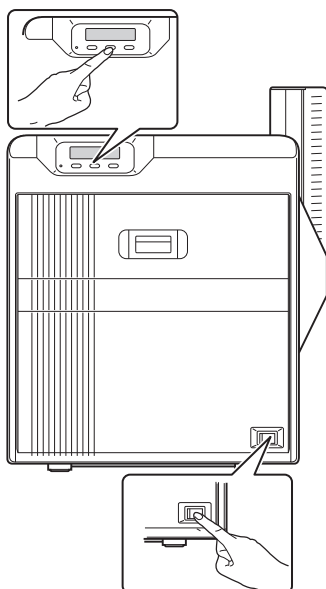

- ② Start data download from the computer
  - A [Downloading..] message appears.
  - A [SBP2 Running] message appears when data download from the computer is complete.
- ③ When the [SBP2 Running] message appears, turn off the power
  - The firmware is updated after the power is turned on again.

Display Mode Setting

- This is used for setting the information to be displayed on the operation panel.

**Settings**

- Counter:  
Displays the counter preset in "Counter setting".
- Laminator State:  
Displays the operating status of the connected laminator. If a laminator is not connected, the counter is displayed.

1 Press **Menu**

- A [Cleaning] message appears.

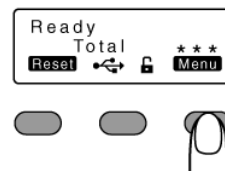

2 Press **Next** to set to [Setting]

- Pressing it each time displays the next setting item.

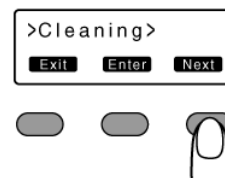

3 Press **Enter**

- A [Display] message appears.

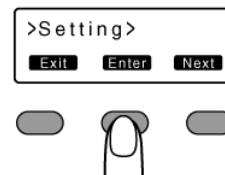

4 Press **Enter**

- A [Mode] message appears.

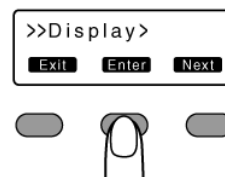

5 Press **Change**

- Enters the settings change mode.

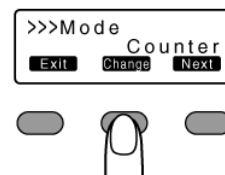

6 Press **Down Arrow** and select a setting

7 Press **Left Arrow** to confirm the setting

- Pressing **Left Arrow** confirms the setting and returns you to the previous screen.

8 Press **Exit** to exit the setting mode

- Pressing it each time displays the setting item on the next higher level.

## Counter Setting

- This is used for setting the type of counter displayed on the operation panel.

### Counter Types

- Total Cnt:** total counter  
Displays the total number of cards that are correctly printed.
- Head Cnt:** head counter  
Displays the total number of printed sides for the same head.
- Free Cnt:** free counter  
Displays the number of cards that are correctly printed. This number can be reset.
- Cleaning Cnt:** cleaning counter  
Displays the number of cards that are correctly printed after the last cleaning.
- Error Cnt:** error counter  
Displays the number of cards that are not correctly printed. This number can be reset.

1 Press **Menu**

- A [Cleaning] message appears.

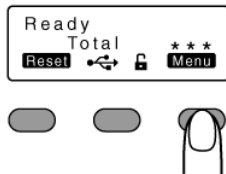

2 Press **Next** to set to [Setting]

- Pressing it each time displays the next setting item.

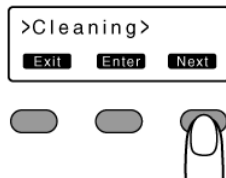

3 Press **Enter**

- A [Display] message appears.

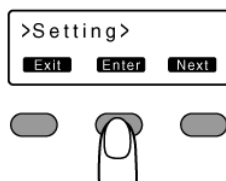

4 Press **Enter**

- A [Mode] message appears.

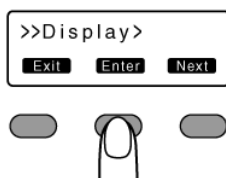

5 Press **Next** to set to [Counter]

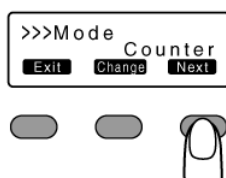

6 Press **Change**

- Enters the settings change mode.

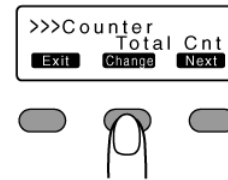

7 Press **Down Arrow** and select a setting

8 Press **Left Arrow** to confirm the setting

- Pressing **Left Arrow** confirms the setting and returns you to the previous screen.

9 Press **Exit** to exit the setting mode

- Pressing it each time displays the setting item on the next higher level.



### Counter Reset

- This is used to reset the free counter and error counter.

1 Press **Menu**

- A [Cleaning] message appears.

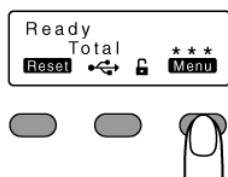

2 Press **Next** to set to [Counter Reset]

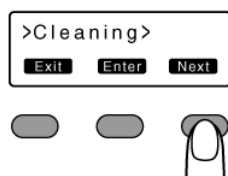

3 Press **Left Arrow**

- Resets the free counter and error counter.

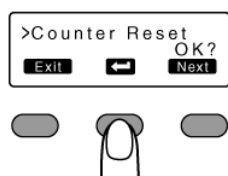

#### ■ Checking reset

- Select [Free Cnt] or [Error Cnt] for "Counter setting".

### Contrast Setting

- For setting the contrast of the operation panel display.

**Settings**

- -3, -2, -1, 0, 1, 2, 3

Selecting a larger value increases the contrast.

1 Press **Menu**

- A [Cleaning] message appears.

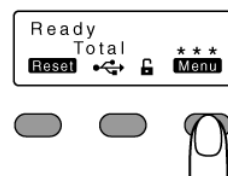

2 Press **Next** to set to [Setting]

- Pressing it each time displays the next setting item.

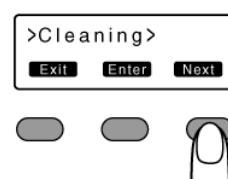

3 Press **Enter**

- A [Display] message appears.

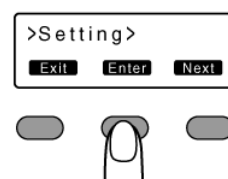

4 Press **Enter**

- A [Mode] message appears.

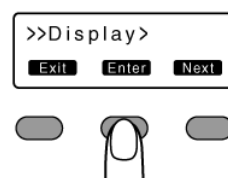

5 Press **Next** to set to [Contrast]

- Pressing it each time displays the next setting item.

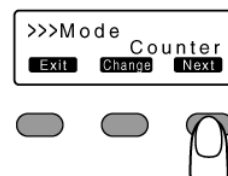

## Operating the Printer

### 6 Press **Change**

- Enters the settings change mode.

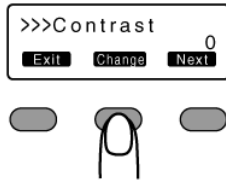

### 7 Press **↓** and select a setting

### 8 Press **←** to confirm the setting

- Pressing **←** confirms the setting and returns you to the previous screen.

### 9 Press **Exit** to exit the setting mode

- Pressing it each time displays the setting item on the next higher level.

## Buzzer Setting

- For setting whether to sound the buzzer when an error occurs or when settings are changed.

### Settings

- On: turns on buzzer sound, Off: turns off buzzer sound

### 1 Press **Menu**

- A [Cleaning] message appears.

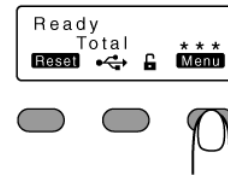

### 2 Press **Next** to set to [Setting]

- Pressing it each time displays the next setting item.

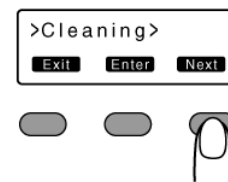

### 3 Press **Enter**

- A [Display] message appears.

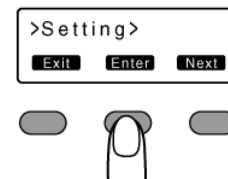

### 4 Press **Next** to set to [Buzzer]

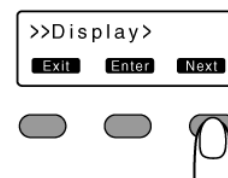

### 5 Press **Change**

- Enters the settings change mode.

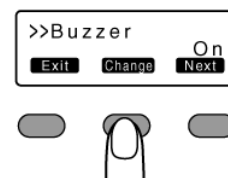

### 6 Press **↓** and select a setting

### 7 Press **←** to confirm the setting

- Pressing **←** confirms the setting and returns you to the previous screen.

### 8 Press **Exit** to exit the setting mode

- Pressing it each time displays the setting item on the next higher level.

## Unit Number Setting

- For setting the printer's unit number according to the USB environment.

### Settings

- No.1 - No.10

1 Press **Menu**

- A [Cleaning] message appears.

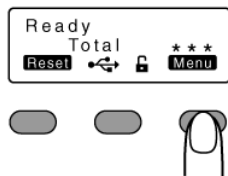

2 Press **Next** to set to [Setting]

- Pressing it each time displays the next setting item.

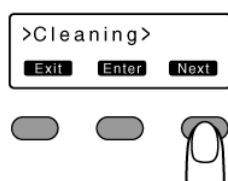

3 Press **Enter**

- A [Display] message appears.

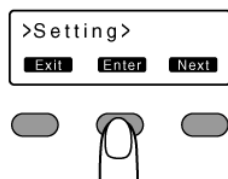

4 Press **Next** to set to [Unit No.]

- Pressing it each time displays the next setting item.

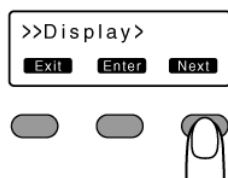

5 Press **Change**

- Enters the settings change mode.

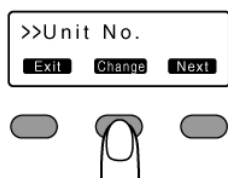

6 Press **↓** and select a setting

- You can select the unit number from No. 1 to No. 10.

7 Press **←** to confirm the setting

- Pressing **←** confirms the setting and returns you to the previous screen.

8 Press **Exit** to exit the setting mode

- Pressing it each time displays the setting item on the next higher level.

9 Turn off the power

- The changes to the setting will be reflected when you turn on the power again.

## Transport Mode Setting

- When transporting or moving the printer, ensure that the heating roller is fastened to a safe position.

### Cautions:

- Make sure that you set to the transport mode when transporting or moving the printer. Failure to do so will cause the printer to malfunction.

1 Open the printer door



2 Press and hold down the cassette button, and remove the ink ribbon cassette (on the right) to remove the ink ribbon

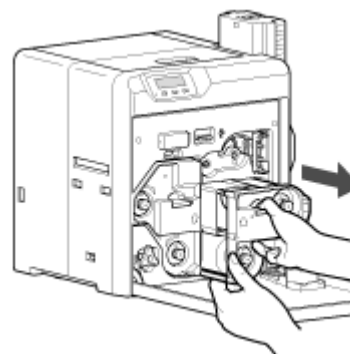

3 Press and hold down the cassette button, and remove the retransfer film cassette (on the left) to remove the retransfer film



4 Close the printer door

## Operating the Printer

5 Press **Reset** → **←** to reset the printer



6 Check to ensure that [Film Search] is displayed on the operation panel of the printer

7 Press **Menu**

- A [Cleaning] message appears.

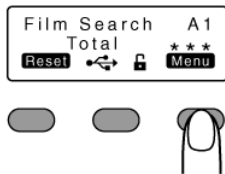

8 Press **Next** to set to [Transport Mode]

- Pressing it each time displays the next setting item.

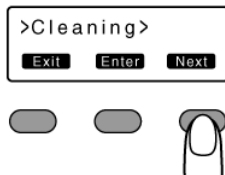

9 Press **←**

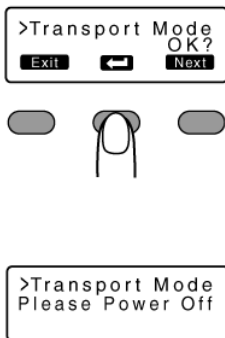

- After setting to the transport mode, a [Please Power Off] message appears.

10 Turn off the power, and install the cassette

### Cautions:

- While in the transport mode, the retransfer film cassette cannot be installed to the printer with the retransfer film loaded.

### ■ Canceling the transport mode

- With the printer door closed, turn on the power to cancel the transport mode.

## Cards

### Cards have Run Out

- Replenish the cards.
- The card hopper is able to store up to about 200 cards with a thickness of 0.76 mm.

### Cautions:

- Get ready cards that are designated by the authorized dealer.
- If the security lock function is turned on, the card hopper will be locked. Turn off the function from the computer. After loading the card, turn on the function again from the computer.
- Do not touch the printing surface of the card. Touching it may cause printing errors. Put on the supplied gloves when handling the cards.
- To prevent card jams from occurring, limit the number of cards stored in the card hopper at any time to about 100 pieces regardless of the card thickness.
- When using new cards, set them after making sure that they are not adhered to each other due to static.
- Align the cards before setting them in the printer. Otherwise, the card hopper cover may not close properly, and this may damage the printer.
- Printing the card on the side with the magnetic stripe may cause printing errors or damage to the card's functions. If you want to do so, please consult our authorized dealers in advance.
- To set cards with both functions (magnetic stripe and contact IC), follow the procedure for setting the contact IC card.

1 Set the card hopper knob to [OPEN]

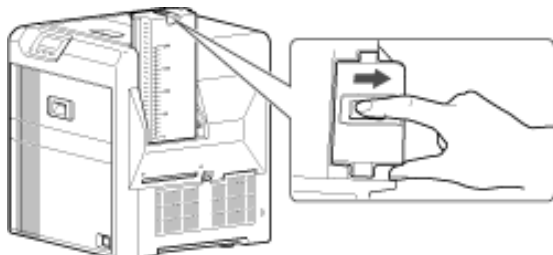

2 Lift to remove the card hopper cover

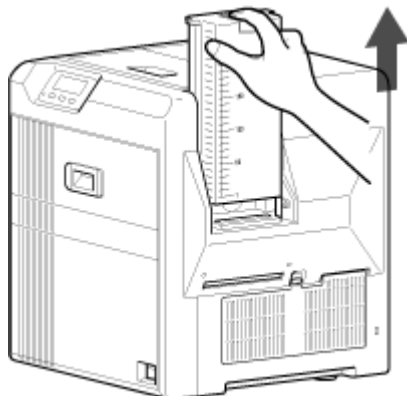

3 Align the orientation of the cards, and set them in the printer

#### ■ Magnetic stripe cards

- Set the card with the magnetic stripe facing upward and toward the printer, or facing downward and toward you.

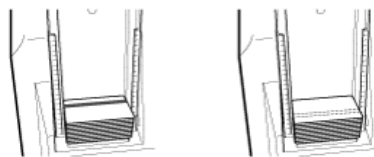

#### ■ ISO contact IC cards

- Set the card with the Contact IC terminal facing upward and toward the rear of the printer, or downward and toward the rear of the printer.
- For single-sided printers, set the cards with the IC terminal facing down and toward the rear of the printer.



4 Install the card hopper cover, and set the card hopper knob to [LOCK]

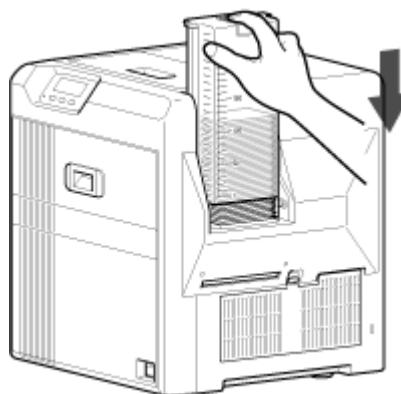

## Ink Ribbon

### Ink Ribbon has Run Out

- Replace with a new ink ribbon.

#### Cautions:

- If the security lock function is turned on, turn off the function from the computer to unlock the printer. After closing the door, turn on the function again from the computer.
- Stand the cassette on a flat surface as illustrated in the diagram. Avoid doing so on the floor as dust attached to it may cause printing errors.

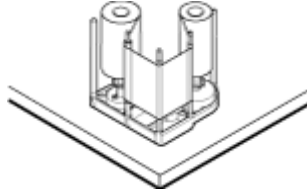

- Do not touch the inked surface (the side that faces outward when installed) with your hand. Touching it may cause printing errors. Put on the supplied gloves when handling the ink ribbon.
- When installing a used ink ribbon, align the yellow side of the unused ribbon with the arrow indicated on the label of the cassette. If the position of the yellow side is not properly aligned, the print may turn out light.
- The cassette is heavy when the ink ribbon is loaded. To prevent the cassette from dropping during handling, make sure to hold it with both hands.
- Do not perform any work on the printer door. Do not place heavy objects or apply load on the printer. Doing so may damage it.
- During replacement, clean the four bobbin holders on the printer. If burrs produced by friction with the bobbins are attached to the bobbin holders, they may fall onto the card, ink ribbon, or retransfer film, causing printing errors.

"Cleaning the bobbin holders" (page 38)

#### 1 Open the printer door



#### 2 Press and hold down the cassette button, and pull out the ink ribbon cassette (on the right) to remove the ink ribbon

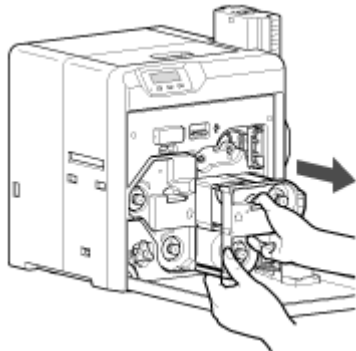

#### 3 Install a new ink ribbon

- Install while referring to the indication on the label of the cassette.

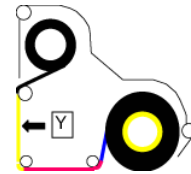

- ① With the inked surface facing outward, align the yellow side of the unused ribbon with the arrow on the cassette, and unwind it along the three shafts.
- ② Insert the ink ribbon firmly into the bobbin holders with the ribbon set to the far end of the guides.
  - A: take-up side (black)
  - B: unused side (yellow)

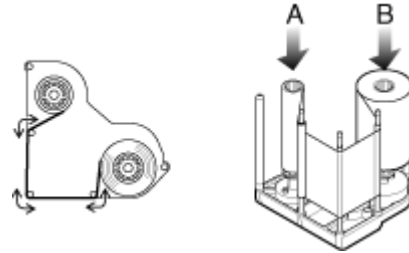

#### 4 Remove any slack in the ink ribbon

- ① Hold the cassette.
- ② Turn the knob in the direction indicated by the arrow.

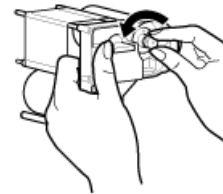

#### 5 Insert the cassette all the way in along the guide rail until a "click" sound is heard, followed by closing the printer door

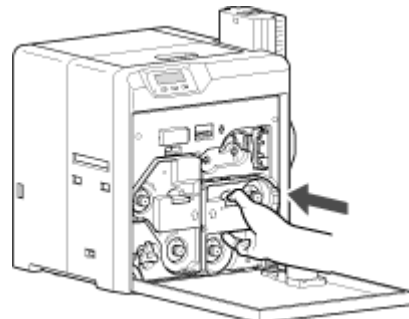
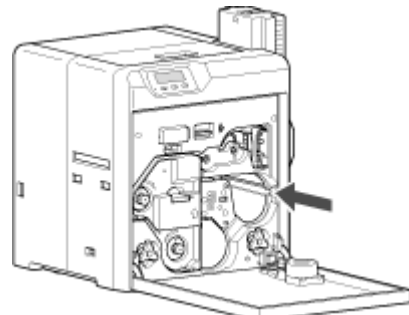

6 Press **Reset** →  to reset the printer



**Memo:**

- To avoid printing errors, it is recommended that you forward by one or two images after installing the ink ribbon cassette or retransfer film cassette.

"Initializing printer when installing the cassette" (page 21)

## Retransfer Film

### Retransfer Film has Run Out

- Replace with a new retransfer film.

**Cautions:**

- If the security lock function is turned on, turn off the function from the computer to unlock the printer. After closing the door, turn on the function again from the computer.
- Stand the cassette on a flat surface as illustrated in the diagram. Avoid doing so on the floor as dust attached to it may cause printing errors.

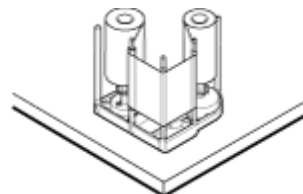

- Do not touch the retransfer face (the side that faces outward when installed) with your hand. Touching it may cause printing errors. Put on the supplied gloves when handling the retransfer film.
- The cassette is heavy when the retransfer film is loaded. To prevent the cassette from dropping during handling, make sure to hold it with both hands.
- When installing a used retransfer film, align the unused side of the film with the arrow indicated on the label of the cassette. Improper alignment may result in errors, or the print may turn out light.
- When installing a new film, make sure that at least three black lines are wound onto the take-up side. Insufficient winding may cause the printer to malfunction.
- Do not perform any work on the printer door. Do not place heavy objects or apply load on the printer. Doing so may damage it.
- During replacement, clean the four bobbin holders on the printer. If burrs produced by friction with the bobbins are attached to the bobbin holders, they may fall onto the card, ink ribbon, or retransfer film, causing printing errors.

"Cleaning the bobbin holders" (page 38)

1 Open the printer door



2 Press and hold down the cassette button, and pull out the retransfer film cassette (on the left) to remove the retransfer film



## Replacement

### 3 Install a new retransfer film

- Install while referring to the indication on the label of the cassette.
  - ① When installing the retransfer film, make sure that at least three black lines are wound onto the take-up side.

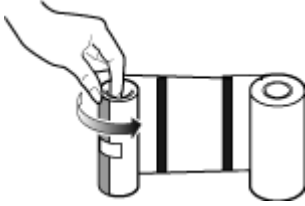

- ② With the retransfer face facing outward, align the unused side of the film with the arrow on the cassette, and unwind it along the three shafts.
  - ③ Insert the retransfer film firmly into the bobbin holders with the film set to the far end of the guides.
- A: take-up side (black)
  - B: unused side (green)

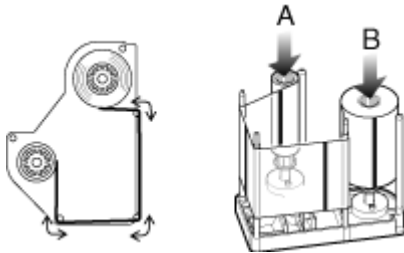

### 4 Remove any slack in the film

- ① Hold the retransfer film cassette.
- ② Turn the knob in the direction indicated by the arrow.

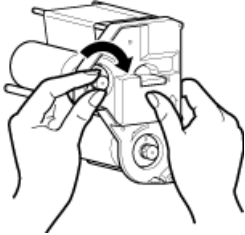

- 5 Insert the cassette all the way in along the guide rail until a “click” sound is heard, followed by closing the printer door

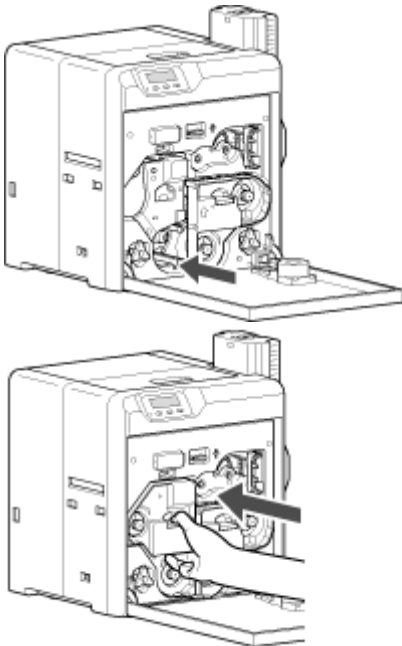

- 6 Press **Reset** →  to reset the printer



### Memo:

- To avoid printing errors, it is recommended that you forward by one or two images after installing the ink ribbon cassette or retransfer film cassette.

"Initializing printer when installing the cassette" (☞ page 21)



## Servicing of Parts

### Request for routine servicing

- In order to prevent printing errors and malfunctions from occurring in advance, please request for routine servicing by the servicing personnel. For details on servicing, please consult our authorized dealers.

### Cleaning Roller

- The function of the cleaning roller is to remove any dirt or dust attached to the card.
- The color of the printed card may appear faded or dirt may appear conspicuous if the cleaning roller is dirty. Card jams may also occur as a result.

### Cautions:

- If the security lock function is turned on, turn off the function from the computer to unlock the printer. After closing the door, turn on the function again from the computer.
- Start work after ensuring that the power has been turned off.
- If the printer is used every day, make sure to clean the cleaning roller daily at the end of the operation.
- Do not perform any work on the printer door. Do not place heavy objects or apply load on the printer. Doing so may damage it.
- After washing, allow the cleaning roller to dry completely before installing it to the printer.
- Do not wash the cleaning roller with anything other than water (e.g., alcohol).
- Replace the cleaning unit with a new one after using it for about one year. For details on its replacement, please consult our authorized dealers.
- After cleaning is complete, check to ensure that all dismantled parts are restored to their original positions. Failure to restore the parts may result in malfunction of the printer.

#### 1 Open the printer door



#### 2 Remove the cleaning unit

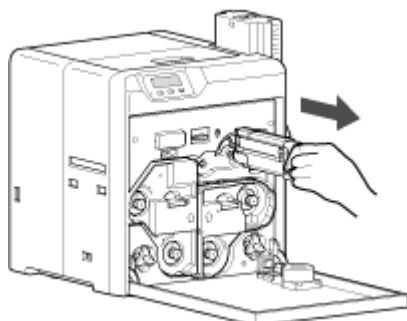

#### 3 Wash the cleaning roller with water

- Wash the roller with water, and remove any dirt from the surface of the cleaning roller with your finger.

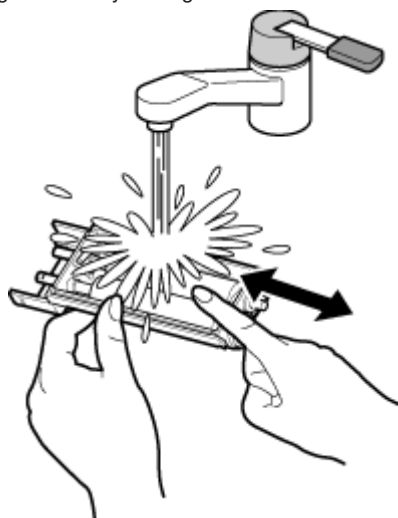

#### 4 Allow the cleaning roller to air dry

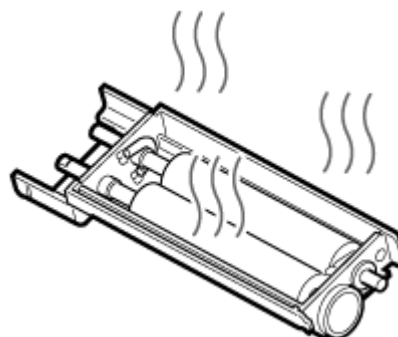

#### 5 Set the cleaning unit, and close the printer door

- With the roller facing the right, insert it all the way in.

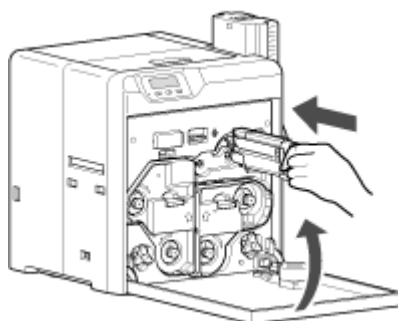

## Card Load Roller

- Card jams may occur if the card load roller is dirty.

### Cautions:

- If the security lock is on, deactivate it. After work is complete, activate the security lock again.
- Start work after ensuring that the power has been turned off.
- After cleaning is complete, check to ensure that all dismantled parts are restored to their original positions. Failure to restore the parts may result in malfunction of the printer.
- For details on separately sold items, please consult our authorized dealers.

1 Remove the card hopper

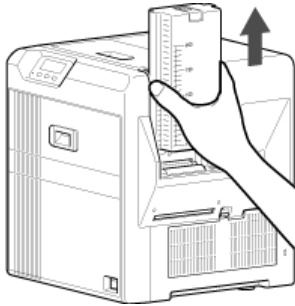

2 Apply alcohol (sold separately) to a wiper (sold separately), and use it to wipe the surface of the card load roller

- Wipe while turning the card load roller in the anti-clockwise direction.



3 Install the card hopper

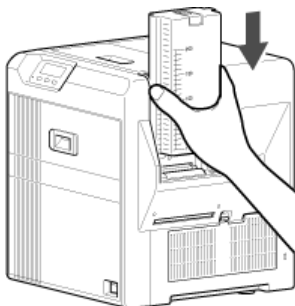

## Fan Filter

- The color of the printed card may appear faded or dirt may appear conspicuous if the fan filter is dirty.
- Perform cleaning after printing about 10,000 cards.

### Cautions:

- Start work after ensuring that the power has been turned off.
- After cleaning is complete, check to ensure that all dismantled parts are restored to their original positions. Failure to restore the parts may result in malfunction of the printer.
- Replace the fan filter with a new one after using it for about one year. For details on its replacement, please consult our authorized dealers.

1 Remove the filter cover located on the side of the printer

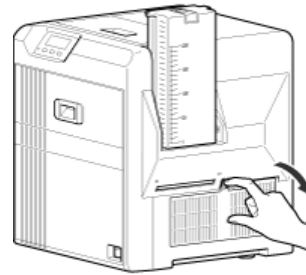

2 Remove the fan filter

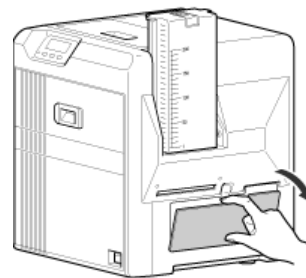

3 Remove any dirt that is attached to the fan filter using a vacuum cleaner

- Hold the filter with your hand to prevent it from being sucked into the vacuum cleaner.

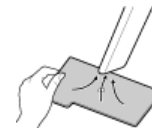

4 Set the fan filter



5 Set the filter cover

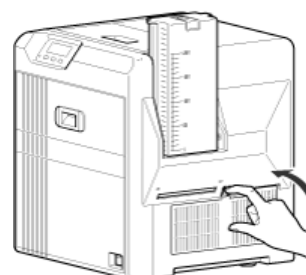

**Card Feed Roller/Heating Roller**

- The color of the printed card may appear faded or dirt may appear conspicuous if the card feed roller or heating roller is dirty.
- Perform cleaning after printing about 1,000 cards.

**Cautions:**

- If the security lock is on, deactivate it. After work is complete, activate the security lock again.
- Before cleaning the card feed roller and heating roller, make sure that you clean the cleaning roller. Otherwise, dirt on the cleaning roller may be attached to the cleaning card, causing its cleaning capability to deteriorate.
- Stand the cassette on a flat surface as illustrated in the diagram. Avoid doing so on the floor as dust attached to it may cause printing errors.

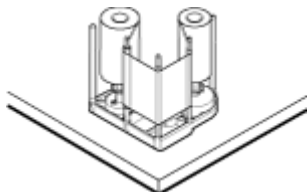

- If card jam occurs when the cleaning card is inserted, turn off and on the power of the printer. Doing so automatically discharges the card.
- Do not perform any work on the printer door. Do not place heavy objects or apply load on the printer. Doing so may damage it.
- Each cleaning card can only be used once. Reusing a dirty card may dirty the roller or cause the printer to malfunction.
- After cleaning is complete, check to ensure that all dismantled parts are restored to their original positions. Failure to restore the parts may result in malfunction of the printer.
- For details on separately sold items, please consult our authorized dealers.

1 Open the printer door. Press and hold down the cassette button, and remove the retransfer film cassette (on the left)

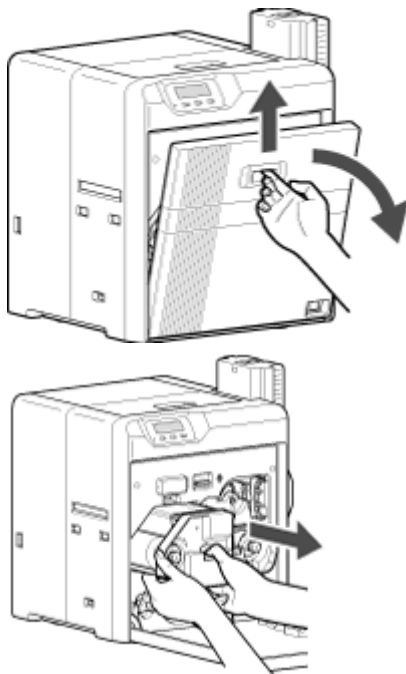

2 Close the printer door

3 Remove the card hopper

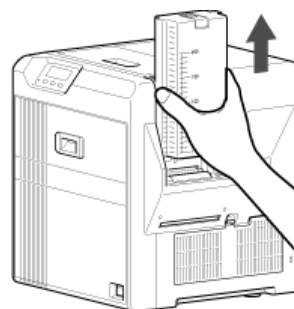

4 Turn on the power

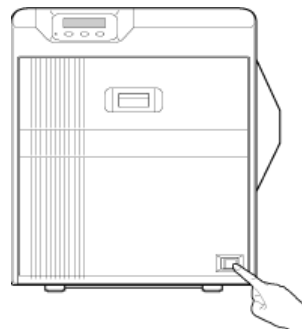

5 Press **Menu** to set to [Cleaning]

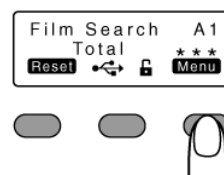

6 Press **Enter** to set to [Rollers]

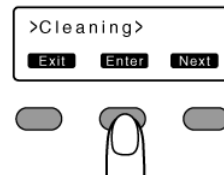

7 Press **Left Arrow**

- A [Film Checking..] message appears, followed by a [Cleaning Start OK?] message.

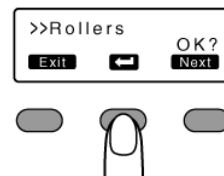

8 Peel off the backing paper from the cleaning card (sold separately)



### 9 Press

- A [Cleaning..] message appears.

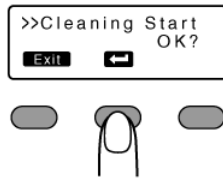

### Cautions:

- If the retransfer heating roller is hot, a [HR is too hot!] message will be displayed. Turn off the power, and perform cleaning after the retransfer heating roller has cooled down completely.

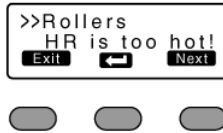





### 10 Insert the cleaning card (sold separately) within 20 seconds

- The roller draws in the card, and cleaning starts automatically.
- A [Cleaning Start OK?] message appears after the card is discharged.



### Cautions:

- Insert the card within 20 seconds after pressing .
- After pressing , the buzzer sounds upon a lapse of 20 seconds, and a [Jam(Hopper)] error message appears about 10 seconds later. Press   to cancel the error.
- When a standard-sized card is inserted, the card is automatically discharged from the NG card outlet, and a [Cleaning Start OK?] message appears.

### 11 Press , and insert the cleaning card again

- Reverse the adhesive face, and insert the card.



- ### 12 After the cleaning card is discharged, turn off the power, install the retransfer film cassette, close the printer door, and install the card hopper

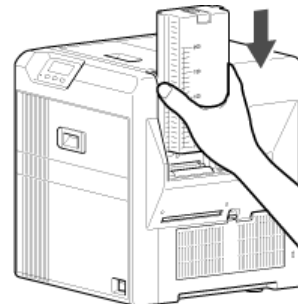
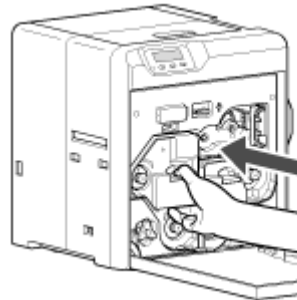
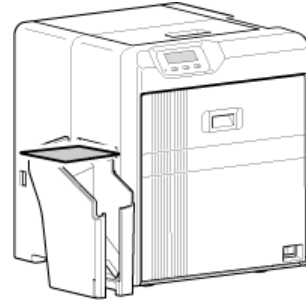

- To turn on the power again, do so after an interval of at least 10 seconds.

**Magnetic Head**

- If the magnetic head is dirty, errors may occur during writing to or reading of the magnetic stripe card.
- Clean the magnetic head after approximately every 1,000 cards.

**Cautions:**

- If the security lock is on, deactivate it. After work is complete, activate the security lock again.
- Before cleaning the magnetic head, make sure that you clean the cleaning roller. Otherwise, dirt on the cleaning roller may be attached to the cleaning card, causing its cleaning capability to deteriorate.
- After cleaning is complete, check to ensure that all dismantled parts are restored to their original positions. Failure to restore the parts may result in malfunction of the printer.
- Do not perform any work on the printer door. Do not place heavy objects or apply load on the printer. Doing so may damage it.
- For details on separately sold items, please consult our authorized dealers.
- Replace the magnetic head cleaning card accordingly if it has become dirty. Using a dirty card may dirty the head and cause malfunction.

1 Turn on the power

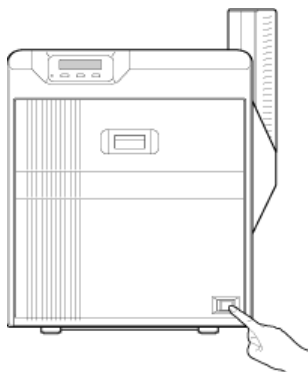

2 Check to ensure that [Ready] or [Preheating..] is displayed on the operation panel of the printer

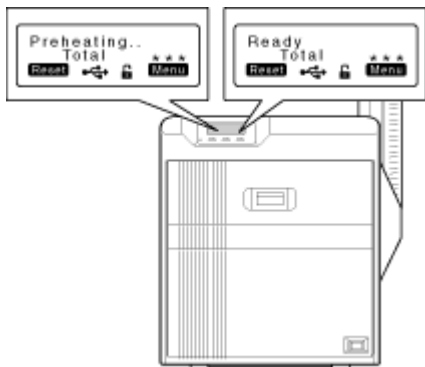

3 Remove the card hopper

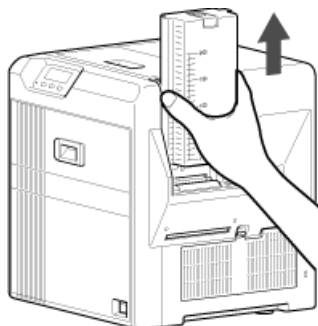

4 Press **Menu** to set to [Cleaning]

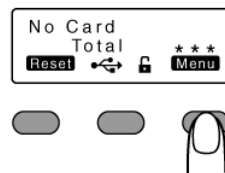

5 Press **Enter** → **Next** to set to [MG]

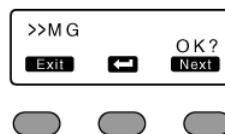
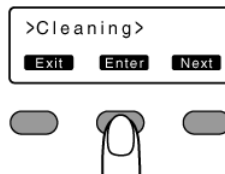

6 Apply alcohol on the magnetic head cleaning card (sold separately)

- Apply about three to four drops of alcohol on the position of the magnetic stripe.



7 Press **←**

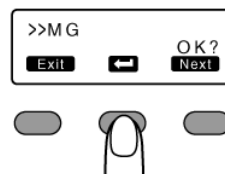

8 Insert the magnetic head cleaning card within 20 seconds

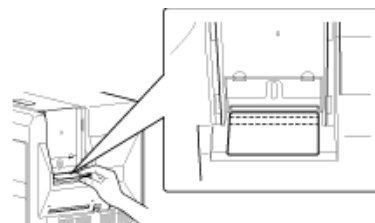

**Cautions:**

- Insert the card within 20 seconds after pressing **←**.
- After pressing **←**, the buzzer sounds upon a lapse of 20 seconds, and a [Jam(Hopper)] error message appears about 10 seconds later. Press **Reset** → **←** to cancel the error.

- 9 After the cleaning card is discharged, turn off the power, and install the card hopper

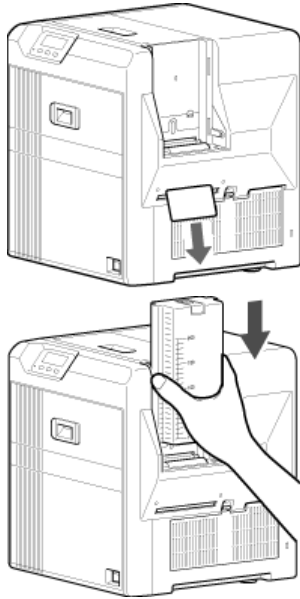

- To turn on the power again, do so after an interval of at least 10 seconds.

### Bobbin Holders

- If burrs produced by friction with the bobbins are attached to the bobbin holders, they may fall onto the card, ink ribbon, or retransfer film, causing printing errors.

### Cautions:

- If the security lock function is turned on, turn off the function from the computer to unlock the printer. After closing the door, turn on the function again from the computer.
- Start work after ensuring that the power has been turned off.
- Stand the cassette on a flat surface as illustrated in the diagram. Avoid doing so on the floor as dust attached to it may cause printing errors.

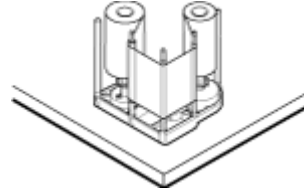

- Do not perform any work on the printer door. Do not place heavy objects or apply load on the printer. Doing so may damage it.
- Perform cleaning each time you replace the ink ribbon or retransfer film.
- After cleaning is complete, check to ensure that all dismantled parts are restored to their original positions. Failure to restore the parts may result in malfunction of the printer.
- For details on separately sold items, please consult our authorized dealers.

- 1 Open the printer door



- 2 Press and hold down the cassette button, and remove the ink ribbon cassette (on the right)

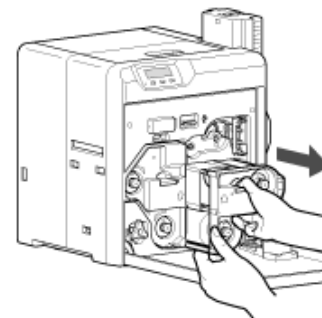

- 3 Press and hold down the cassette button, and remove the retransfer film cassette (on the left)



- 4 Apply alcohol to a cotton swab (large), and use it to wipe the four bobbin holders  
(Cotton swab and alcohol: sold separately)

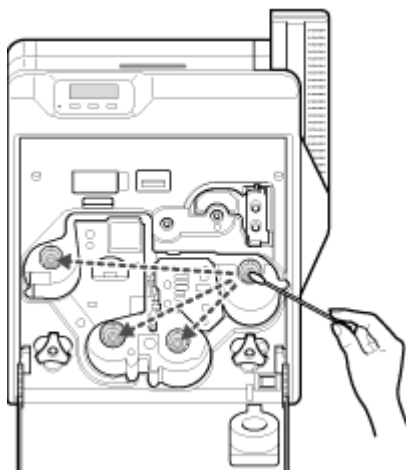

- 5 Insert the retransfer film cassette along the guide rail until a “click” sound is heard

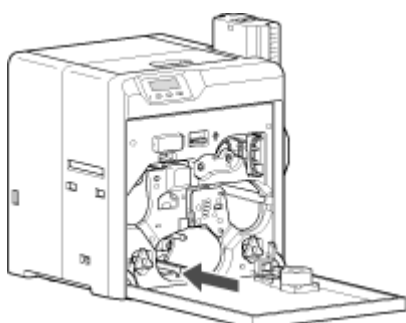

- 6 Insert the ink ribbon cassette along the guide rail until a “click” sound is heard, followed by closing the printer door

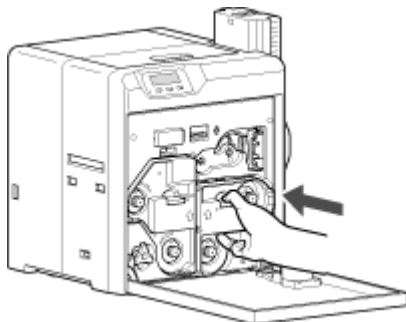
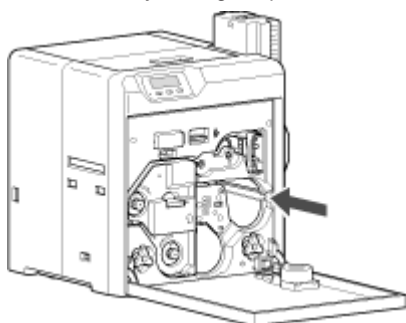

**Thermal Head**

- Lines may appear on the card after printing if the thermal head is dirty.
- Clean the thermal head after printing about 10,000 images.

**Cautions:**

- If the security lock function is turned on, turn off the function from the computer to unlock the printer. After closing the door, turn on the function again from the computer.
- Start work after ensuring that the power has been turned off.
- Stand the cassette on a flat surface as illustrated in the diagram. Avoid doing so on the floor as dust attached to it may cause printing errors.

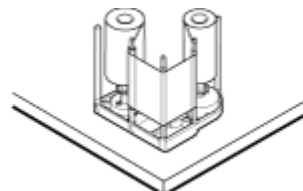

- Do not perform any work on the printer door. Do not place heavy objects or apply load on the printer. Doing so may damage it.
- Touching the thermal head with your body electrostatically charged may cause damage to the head. Make sure that you touch the metallic part of the printer before commencing work.
- Pay attention to prevent metallic objects from knocking against the thermal head. Doing so may damage it.
- After cleaning is complete, check to ensure that all dismantled parts are restored to their original positions. Failure to restore the parts may result in malfunction of the printer.
- For details on separately sold items, please consult our authorized dealers.

- 1 Open the printer door



- 2 Press and hold down the cassette button, and remove the ink ribbon cassette (on the right)

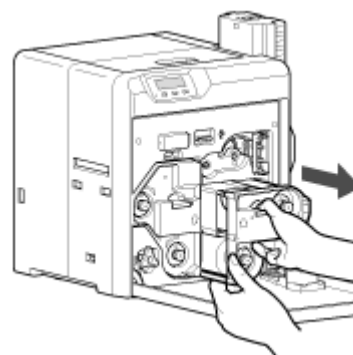

## Maintenance

- 3 Press and hold down the cassette button, and remove the retransfer film cassette (on the left)



- 4 Apply alcohol to a cotton swab (large), and use it to wipe the thermal head  
(Cotton swab and alcohol: sold separately)

- Wipe the thermal head with care in the horizontal direction.

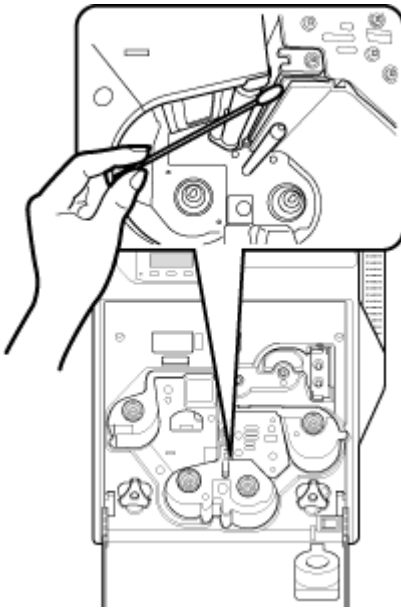

- 5 Insert the retransfer film cassette along the guide rail until a “click” sound is heard

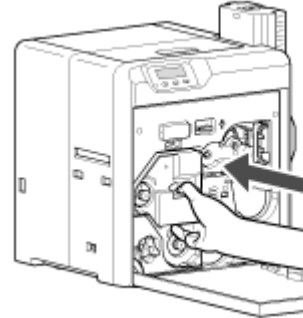
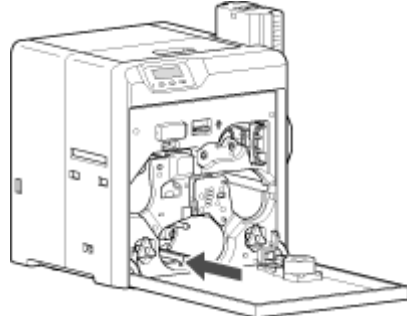

- 6 Insert the ink ribbon cassette along the guide rail until a “click” sound is heard, followed by closing the printer door

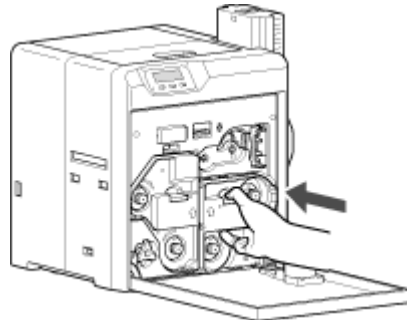
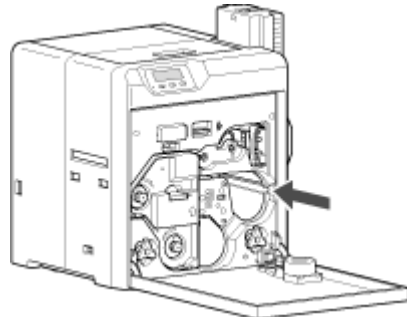



---

## Servicing Based on Print Output

---

### Colors Appear Faded or Dirt is Conspicuous

- "Clean the cleaning roller." (☞ page 33)
  - "Clean the fan filter." (☞ page 34)
  - "Clean the card feed roller/heating roller." (☞ page 35)
  - "Clean the bobbin holders." (☞ page 38)
- 

### Card Jam

- "Clean the cleaning roller." (☞ page 33)
  - "Clean the card load roller." (☞ page 34)
- 

### Error During Writing to or Reading of Magnetic Stripe Card

- "Clean the magnetic head." (☞ page 37)
- 

### Lines Appear on Card after Printing

- "Clean the thermal head." (☞ page 39)

## When an Error Message is Displayed

- Check the error code and error code number displayed on the operation panel.

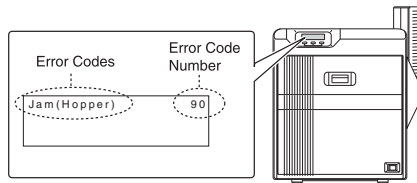

### List of Error Codes

- Click on an error code below to jump to the page with the corresponding error descriptions.

"44" (page 43) "90" (page 42) "91" (page 42)  
 "92" (page 42) "93" (page 42) "94" (page 42)  
 "95" (page 42)  
 "A1" (page 42) "A2" (page 42) "A8" (page 42)  
 "AB" (page 43) "AC" (page 43)  
 "B0" (page 42) "B1" (page 42) "B2" (page 43)  
 "C1" (page 43) "C2" (page 43) "C3" (page 43)  
 "D1" (page 42) "D8" (page 43)  
 "F0" (page 43) "F1" (page 43) "F2" (page 43)  
 "F3" (page 43) "F4" (page 43) "F5" (page 43)  
 "F6" (page 43) "F8" (page 43)

### No Card



- Cards have run out.  
"Replenish the cards." (page 29)
- The card hopper is not installed.  
Install the card hopper.

#### Memo:

- The operation panel display appears blinking when the cards have run out or when the card hopper is not installed.

### Jam(Hopper) 90

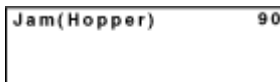

- Card jam near the card hopper and cleaning roller.  
"Remove the jammed card." (page 44)

### Jam(TurnOver) 91

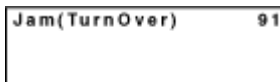

- Card jam near the card turn over unit.  
"Remove the jammed card." (page 45)

### Jam(MG) 92

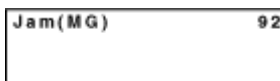

- Card jam in the magnetic encoder unit.  
"Remove the jammed card." (page 47)

### Jam(Transfer) 93

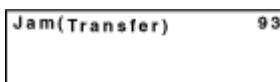

- Card jam in the card feed roller.  
"Remove the jammed card." (page 48)

### Jam(Discharge) 94



- Card jam near the card outlet.  
"Remove the jammed card." (page 49)

### Jam(Retrans.) 95

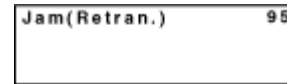

- Card jam near the retransfer heating roller.  
"Remove the jammed card." (page 50)

### Film Search A1



- Retransfer film is broken.  
"Repair the retransfer film." (page 54)

### MG Test Err A8

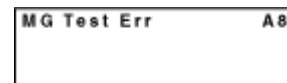

- A writing error has occurred during magnetic encoder self-diagnosis.  
Press **Reset** → **←** to reset the printer.

### Ink Error B0

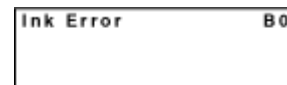

- An incorrect ink ribbon is installed.  
Install a correct ink ribbon.

### Ink Search B1

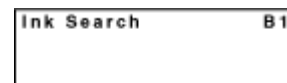

- Ink ribbon is broken.  
"Repair the ink ribbon." (page 52)

### Door Open D1



- The printer door is open.  
Close the printer door, and press **Reset** → **←** to reset the printer.
- Cleaning unit is not installed.  
Install the cleaning unit, close the printer door, and press **Reset** → **←** to reset the printer.

#### Memo:

- The operation panel display appears blinking when the printer door is open or when the cleaning unit is not installed.

### Film Run Out A2

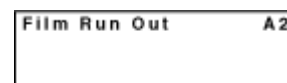

- Retransfer film has run out.  
"Replace with a new one." (page 31)

**Ink Run Out B2**

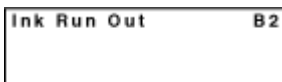

- Ink ribbon has run out.  
"Replace with a new one." (☞ page 30)

**Hardware 44**



- A hardware failure has occurred on the printer.  
Turn off and on the power again. If the same problem recurs, turn off the power and consult our authorized dealers.

**MG Mechanical AB**

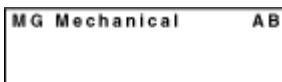

- An error has occurred in the mechanical component of the magnetic encoder.  
Turn off and on the power again. If the same problem recurs, turn off the power and consult our authorized dealers.

**MG Hardware AC**

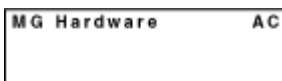

- A hardware failure has occurred on the magnetic encoder.  
Turn off and on the power again. If the same problem recurs, turn off the power and consult our authorized dealers.

**Cam Error C1**

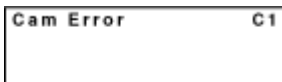

- A heating roller operation error has occurred.  
Turn off and on the power again. If the same problem recurs, turn off the power and consult our authorized dealers.

**HR Overheat C2**



- The temperature of the bend remedy heating roller or retransfer heating roller is too high.  
Turn off and on the power again. If the same problem recurs, turn off the power and consult our authorized dealers.

**Hardware D8**



- A hardware error has occurred during initialization.  
Turn off and on the power again. If the same problem recurs, turn off the power and consult our authorized dealers.

**TR Overheat F0**



- The temperature of the retransfer heating roller is too high.  
Turn off and on the power again. If the same problem recurs, turn off the power and consult our authorized dealers.

**TR Heater F1**



- The retransfer heating roller is faulty.  
Turn off and on the power again. If the same problem recurs, turn off the power and consult our authorized dealers.

**TR Thermister F2**



- The retransfer heating roller thermistor is faulty.  
Turn off and on the power again. If the same problem recurs, turn off the power and consult our authorized dealers.

**RR Overheat F3**



- The temperature of the bend remedy heating roller is too high.  
Turn off and on the power again. If the same problem recurs, turn off the power and consult our authorized dealers.

**RR Heater F4**



- The bend remedy unit is faulty.  
Turn off and on the power again. If the same problem recurs, turn off the power and consult our authorized dealers.

**RR Thermister F5**



- The bend remedy heating roller thermistor is faulty.  
Turn off and on the power again. If the same problem recurs, turn off the power and consult our authorized dealers.

**Overcool F6**



- The operating ambient temperature of the printer is too low.  
Check the temperature. If the same problem recurs within the range of operating ambient temperature, turn off the power and consult our authorized dealers.

**Head Overheat F8**



- The temperature of the thermal head is too high.  
Turn off and on the power again. If the same problem recurs, turn off the power and consult our authorized dealers.

**Power Intrpt C3**



- An instantaneous interruption is detected.  
Turn off and on the power again. If the same problem recurs, turn off the power and consult our authorized dealers.

## Cards

### Cards have Run Out

- "Replenish the cards." (☞ page 29)

### Card Jam

- Error codes are displayed on the operation panel according to the location of the card jam.
- Check the error code, and remove the card according to the corresponding procedure.

### Cautions:

- If the card cannot be removed, do not try to do so forcibly. Consult our authorized dealers or the servicing personnel.
- If the security lock is on, deactivate it. After work is complete, activate the security lock again.
- Do not apply excessive force on the card hopper. Doing so may damage it.
- Do not touch the printing surface of the card. Touching it may cause printing errors. Put on the supplied gloves when handling the cards.

### Error Code Jam(Hopper) 90

- Card jam near the card hopper and cleaning roller.

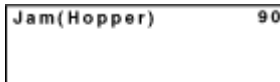

- 1 Detach the card hopper cover, and remove the unused cards

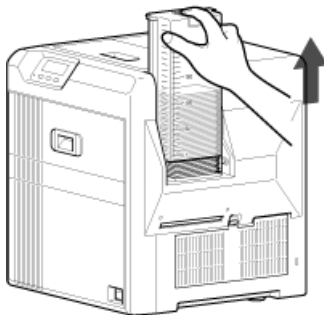

- 2 Remove the jammed card with a hand

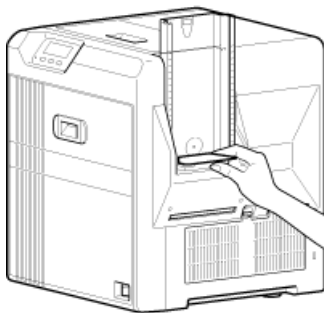

"If the card cannot be removed by hand" (☞ page 44)

- 3 Return the unused cards to their original position

- 4 Install the card hopper cover

### ■ If the card cannot be removed by hand

- ① Press **Reset** → **←** to reset the printer



- The card is discharged from the NG card outlet.

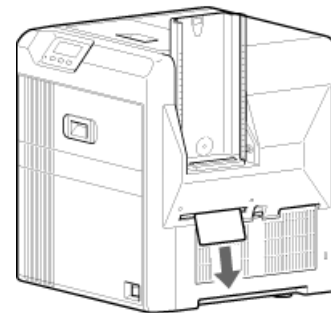

"Go to step 3" (☞ page 44)

"If the card cannot be discharged" (☞ page 45)

■ If the card cannot be discharged

- ① Turn off the power
- ② Open the printer door, and check the position of the jammed card



- ③ Attach the jog dial to the cleaning roller shaft

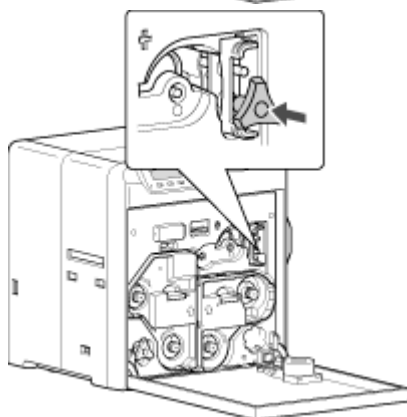
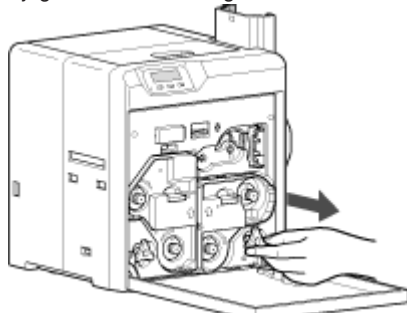

- ④ Turn the cleaning roller shaft in the clockwise direction, while checking the position of the card

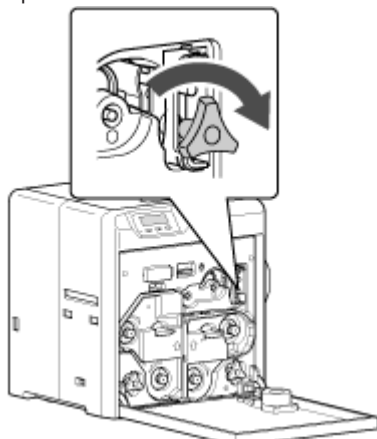

- ⑤ Remove the card after it is discharged from the card load slot

**Cautions:**

- If the card cannot be removed, do not try to do so forcibly. Consult our authorized dealers or the servicing personnel.

- ⑥ Restore the jog dial to its original position, and close the printer door

- ⑦ Turn on the power  
"Go to step 3" (page 44)

**Error Code Jam(TurnOver) 91**

- Card jam near the card turn over unit.



- 1 Turn off the power
- 2 Remove the card hopper

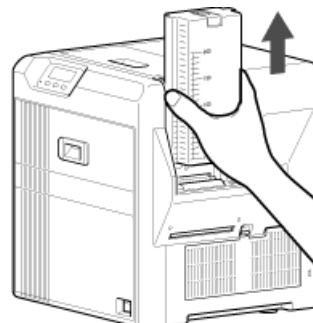

- 3 Detach the card load slot cover



- 4 Open the printer door, and remove the cleaning unit

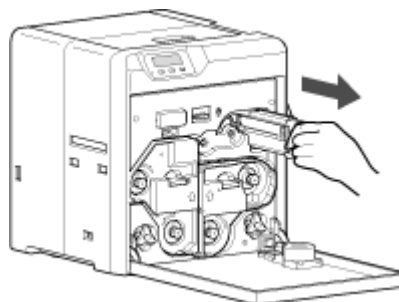

## Troubleshooting

- 5 Remove the jammed card in the card turn over unit from the card load slot

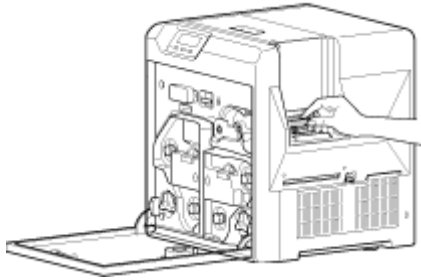

"If the card cannot be removed" (☞ page 46)

- 6 Install the cleaning unit

- 7 Attach the jog dial to the card turn over unit shaft, and set the card turn over unit to "Home Pos."

- "Home Pos." is the position where the slit on the jog dial points to the right and the card turn over unit is horizontal.

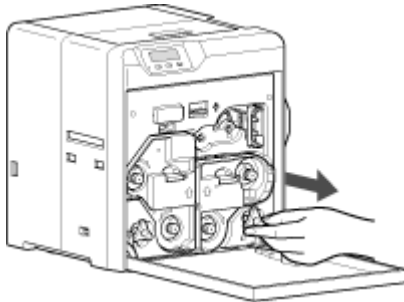

Home Pos.

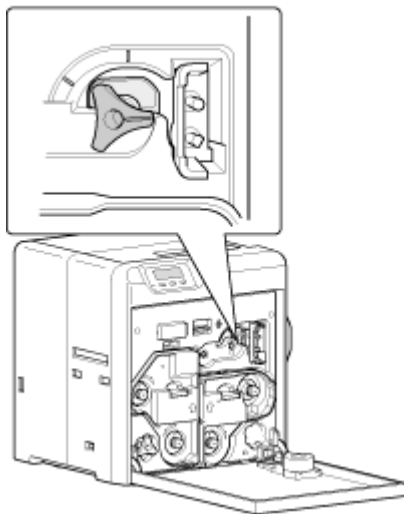

- 8 Restore the jog dial to its original position

- 9 Install the card load slot cover and card hopper, and close the printer door

- 10 Turn on the power

### Cautions:

- When a Jam(TurnOver) error occurs, the [Jam(TurnOver)] message will not disappear after removing the jammed card until the card turn over unit is set to "Home Pos."
- If the printer door is opened when a Jam(TurnOver) error occurs, a [Please Adjust Turn Unit Pos!] message will be displayed. Remove the jammed card, and set the card turn over unit to "Home Pos."

### ■ If the card cannot be removed

- ① Install the cleaning unit
- ② Attach the jog dial to the cleaning roller shaft and card turn over unit shaft

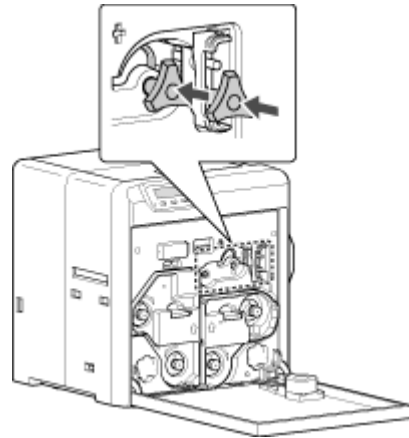
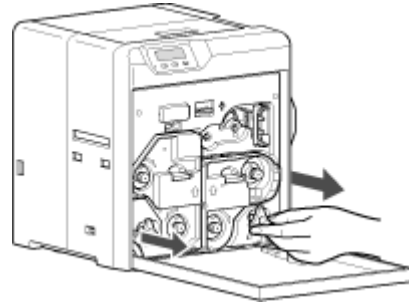

- ③ Set the card turn over unit to "Home Pos."

- "Home Pos." is the position where the slit on the jog dial points to the right and the card turn over unit is horizontal.

Home Pos.

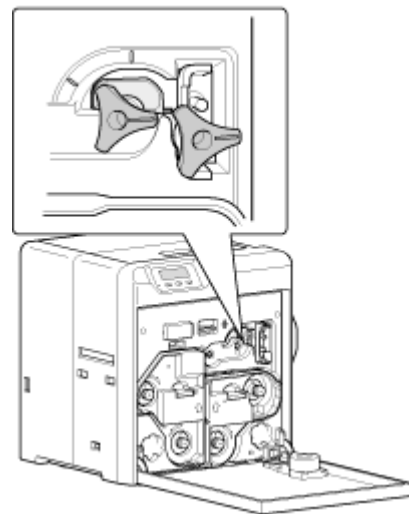

- If the card protrudes from the card turn over unit, turn the cleaning roller shaft to move the card into the unit.

- Turning the card turn over unit moves the card inside the unit outward. Turn the card turn over unit while turning the cleaning roller shaft so that the card is retained inside the card turn over unit, and set to "Home Pos."

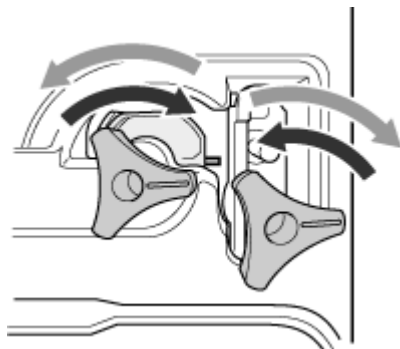

**Cautions:**

- When the card turn over unit cannot be turned, do not turn it forcibly with the jog dial. Doing so may cause the card turn over unit to malfunction.

- ④ Turn the cleaning roller shaft in the clockwise direction

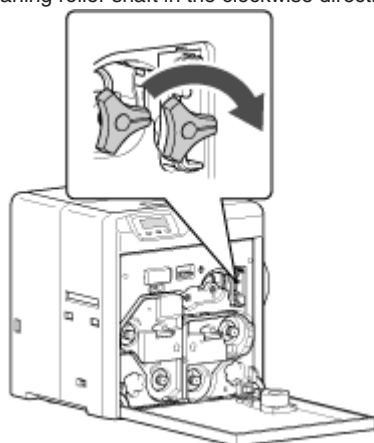

- ⑤ Remove the card after it is discharged from the card load slot

**Cautions:**

- If the card cannot be removed, do not try to do so forcibly. Consult our authorized dealers or the servicing personnel.

"Go to step 8" (page 46)

**Error Code Jam(MG) 92**

- Card jam in the magnetic encoder unit.

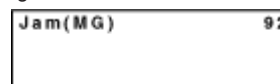

- 1 Press **Reset** to reset the printer

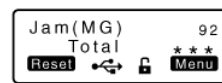

- The card is discharged from the NG card outlet.

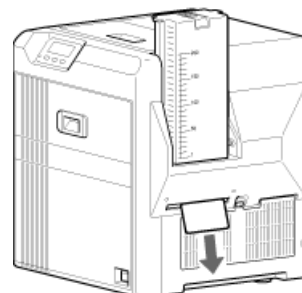

## Error Code Jam(Transfer) 93

- Card jam in the card feed roller.

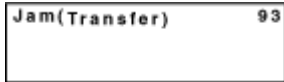

Press **Reset** → to reset the printer



- The card is discharged from the NG card outlet.

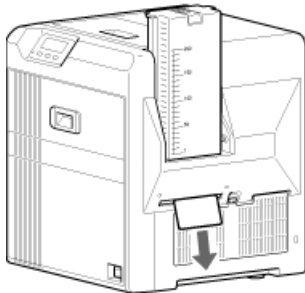

### ■ If the card cannot be discharged

- ① Turn off the power, and detach the card hopper

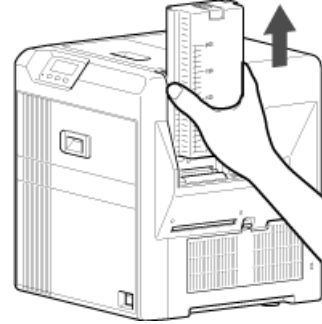

- ② Open the printer door, and check the position of the jammed card
- ③ Attach the jog dial to the card feed roller shaft and cleaning roller shaft

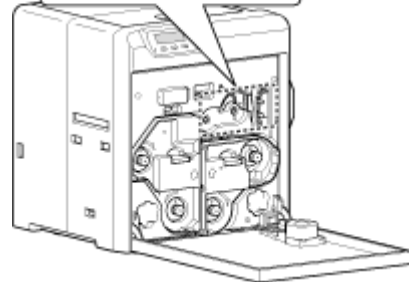
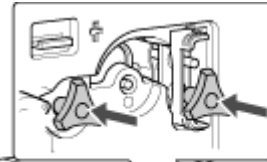
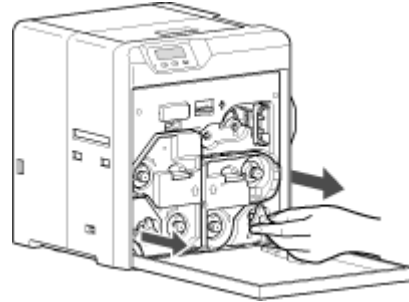

- ④ Turn the card feed roller shaft and cleaning roller shaft in the clockwise direction, while checking the position of the card

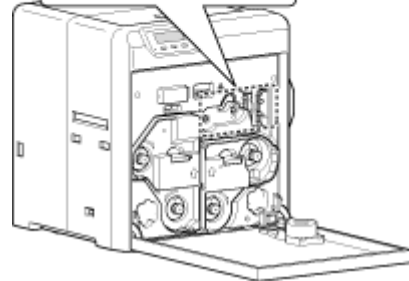
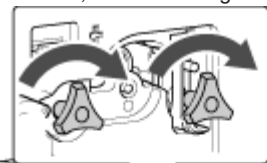

- Remove the card after it is discharged from the card load slot.  
(For single-sided printers, the card is discharged from the NG card outlet.)

### Cautions:

- If the card cannot be removed, do not try to do so forcibly.  
Consult our authorized dealers or the servicing personnel.

- ⑤ Restore the jog dial to its original position
- ⑥ Install the card hopper, and close the printer door
- ⑦ Turn on the power



**Error Code Jam(Discharge) 94**

- Card jam near the card outlet.

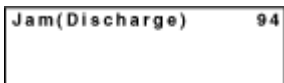

1 Press **Reset** → to reset the printer

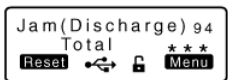

- The card is discharged from the card outlet.

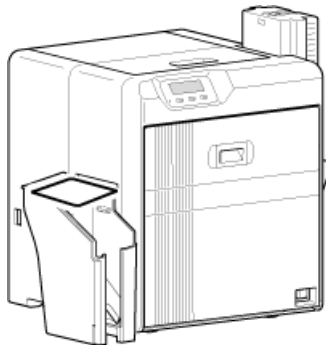

■ **If the card cannot be discharged**

- 1 Turn off the power, and open the printer door
- 2 Pull out the retransfer film cassette, and check the position of the card



- 3 Attach the jog dial to the card feed roller shaft

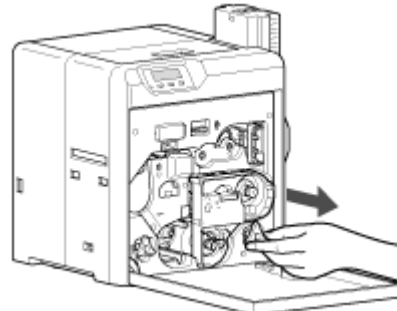

- 4 Turn the card feed roller shaft in the anti-clockwise direction, while checking the position of the card

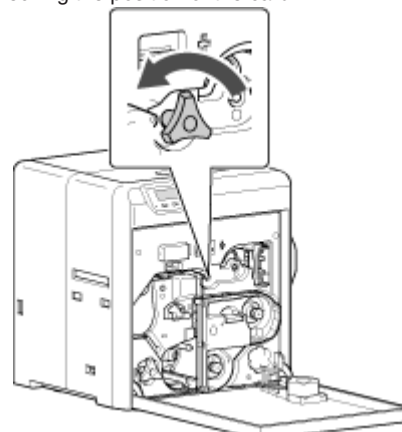

- The card is discharged from the card outlet.

**Cautions:**

- If the card cannot be removed, do not try to do so forcibly. Consult our authorized dealers or the servicing personnel.

- 5 Restore the jog dial to its original position, and install the retransfer film cassette
- 6 Close the printer door, and turn on the power

## Error Code Jam(Retrans.) 95

- Card jam near the retransfer heating roller.

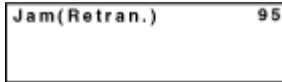

1 Open the printer door

- A [Please Remove Jam Card!] or [Please Close Door] message appears.

2 Pull out the retransfer film cassette



### Cautions:

- The card may be adhered to the retransfer film. Pull out the retransfer film while taking care not to jam it.
- If a [Please Close Door] message is displayed, the retransfer film is stuck and the retransfer film cassette cannot be removed. In this case, close the printer door before pulling out the retransfer film cassette.

3 Remove the jammed card

"If the card is adhered to the retransfer film" (page 50)

"If the card is inside the printer unit" (page 51)

"If the card is caught in the card feed roller to the right of the retransfer heating roller" (page 51)

"If the card is caught in the card feed roller to the left of the retransfer heating roller" (page 52)

4 Install the retransfer film cassette, and close the printer door

5 Press **Reset**

- A [Jam Card Removed?] message appears.



6 Press **Yes**

### Cautions:

- Initializing the printer without first removing the card will cause the printer to malfunction. Be sure to remove the card then press **Yes**.
- An [Initializing..] message appears, and initialization of the printer starts.

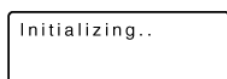
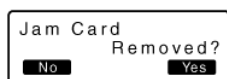

### ■ If the card is adhered to the retransfer film

- Remove the jammed card with a hand.

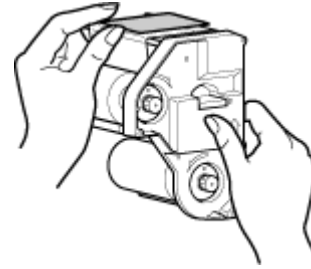

### Cautions:

- The card may be very hot. Be careful not to burn your fingers when removing the card.

"Go to step 4" (page 50)

■ If the card is inside the printer unit

- If the card is not drawn into the card feed roller and is left inside the printer, use the tweezers (supplied) to remove the card.

- ① Turn off the power
- ② Check the position of the card that is left inside the printer

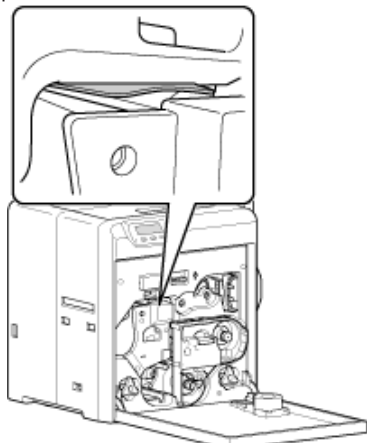

- ③ Pick up the card using the tip of the tweezers (supplied)
- Be careful not to drop the card inside the printer.
- ④ Pull out the card slowly

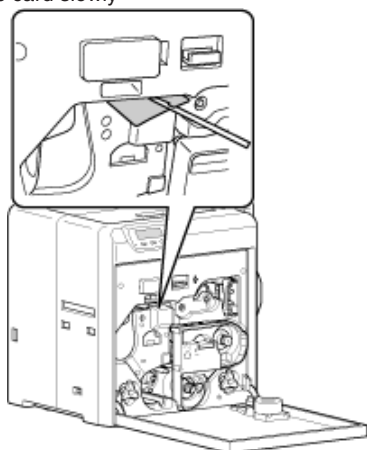

**Cautions:**

- The card may be very hot. Be careful not to burn your fingers when removing the card.
- If the card cannot be removed, do not try to do so forcibly. Consult our authorized dealers or the servicing personnel.

**Memo:**

Example of how to pick up the card



- Pick up the card by following the diagram above.

- ⑤ Install the retransfer film cassette, and close the printer door

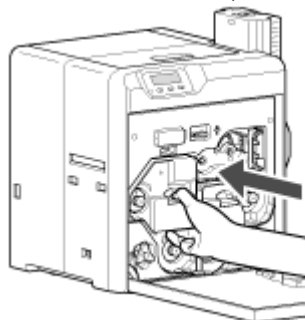

- ⑥ Turn on the power  
"Go to step 5" (page 50)

■ If the card is caught in the card feed roller to the right of the retransfer heating roller

- ① Turn off the power, and detach the card hopper

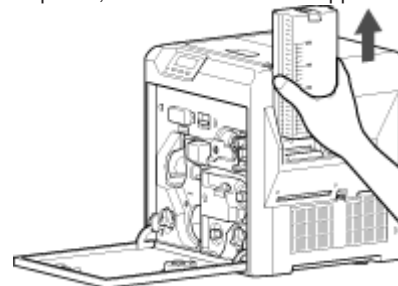

- ② Check the position of the card
- ③ Attach the jog dial to the card feed roller shaft and cleaning roller shaft

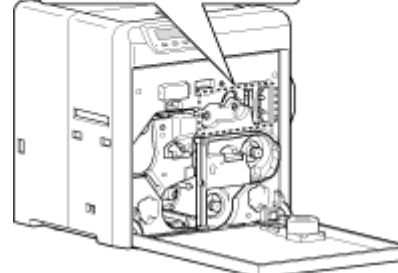
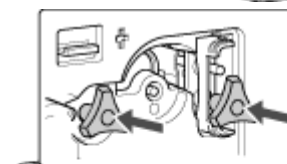
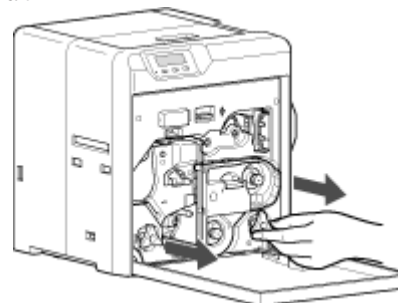

- ④ Turn the card feed roller shaft and cleaning roller shaft in the clockwise direction, while checking the position of the card

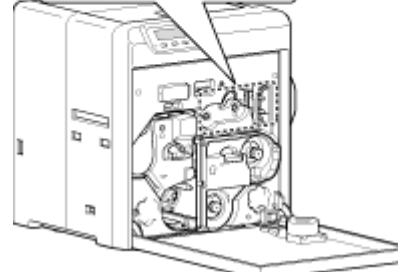
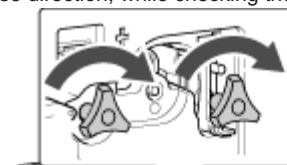

- Remove the card after it is discharged from the card load slot. (For single-sided printers, the card is discharged from the NG card outlet.)

**Cautions:**

- If the card cannot be removed, do not try to do so forcibly. Consult our authorized dealers or the servicing personnel.

- ⑤ Restore the jog dial to its original position, and install the card hopper
- ⑥ Install the retransfer film cassette, and close the printer door
- ⑦ Turn on the power  
"Go to step 5" (page 50)

■ If the card is caught in the card feed roller to the left of the retransfer heating roller

- ① Turn off the power
- ② Check the position of the card
- ③ Attach the jog dial to the card feed roller shaft

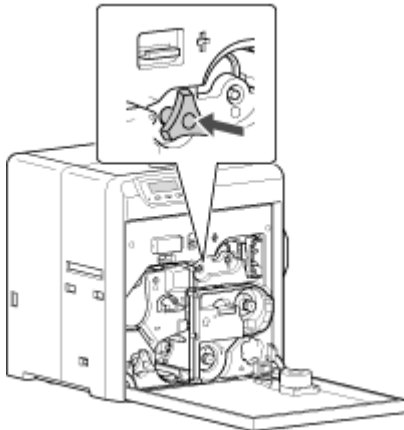
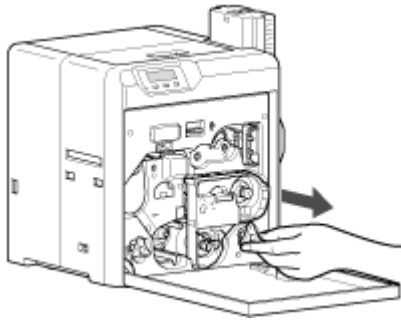

- ④ Turn the card feed roller shaft in the anti-clockwise direction, while checking the position of the card

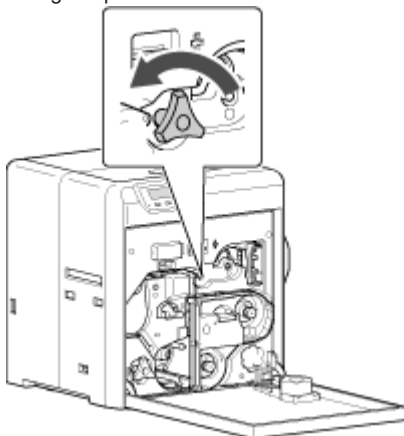

- The card is discharged from the card outlet.

**Cautions:**

- If the card cannot be removed, do not try to do so forcibly. Consult our authorized dealers or the servicing personnel.

- ⑤ Restore the jog dial to its original position
  - ⑥ Install the retransfer film cassette, and close the printer door
  - ⑦ Turn on the power
- "Go to step 5" (page 50)

## Ink Ribbon

### Ink Ribbon has Run Out

- "Replace with a new ink ribbon." (page 30)

### Ink Ribbon is Broken

- Repair the ink ribbon.

**Cautions:**

- If the security lock function is turned on, turn off the function from the computer to unlock the printer. After closing the door, turn on the function again from the computer.
- Stand the cassette on a flat surface as illustrated in the diagram. Avoid doing so on the floor as dust attached to it may cause printing errors.

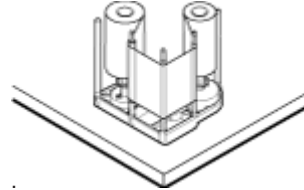

- Do not touch the inked surface (the side that faces outward when installed) with your hand. Touching it may cause printing errors. Put on the supplied gloves when handling the ink ribbon.
- The cassette is heavy when the ink ribbon is loaded. To prevent the cassette from dropping during handling, make sure to hold it with both hands.
- When installing a used ink ribbon, align the yellow side of the unused ribbon with the arrow indicated on the label of the cassette. If the position of the yellow side is not properly aligned, the print may turn out light.
- Do not perform any work on the printer door. Do not place heavy objects or apply load on the printer. Doing so may damage it.
- During replacement, clean the four bobbin holders on the printer. If burrs produced by friction with the bobbins are attached to the bobbin holders, they may fall onto the card, ink ribbon, or retransfer film, causing printing errors.

"Cleaning the bobbin holders" (page 38)

### 1 Open the printer door



- 2 Press and hold down the cassette button, and remove the ink ribbon cassette (on the right)

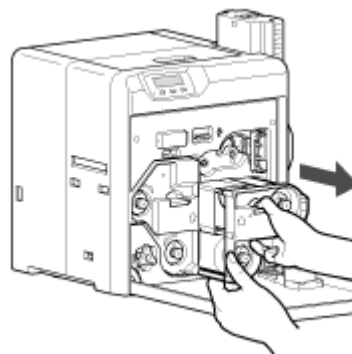

- 3 Cut away the broken portion, and attach the unused portion at the supply side to the other end at the take-up side using an adhesive tape, while making sure that the joint surface is even

**Cautions:**

- Do not discard the used ribbon at the take-up side.

4 Turn the take-up side using your hand until the broken portion can no longer be seen

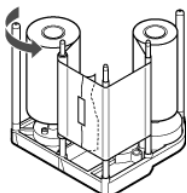

- Align the yellow side of the unused portion with the arrow indicated on the label of the cassette.

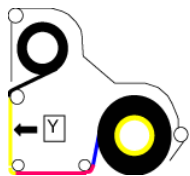

5 Remove any slack in the ink ribbon

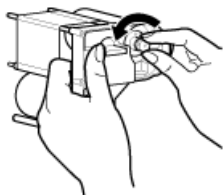

6 Insert the cassette all the way in along the guide rail until a “click” sound is heard, followed by closing the printer door

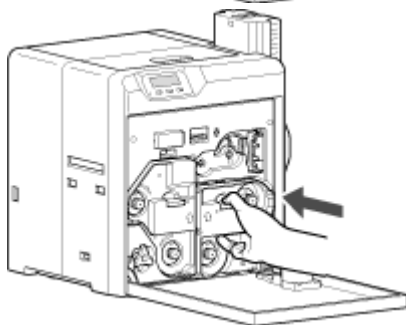
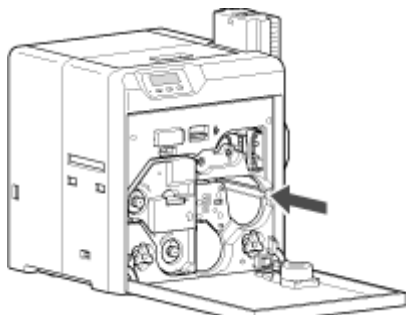

7 Press **Reset** →  to reset the printer

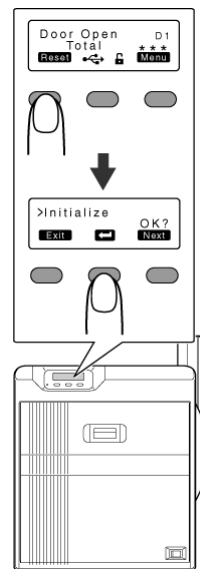

**Memo:**

- To avoid printing errors, it is recommended that you forward by one or two images after installing the ink ribbon cassette or retransfer film cassette.

"Initializing printer when installing the cassette" (☞ page 21)

## Retransfer Film

### Retransfer Film has Run Out

- "Replace with a new retransfer film." (page 31)

### Retransfer Film is Broken

- Repair the retransfer film.

#### Cautions:

- If the security lock function is turned on, turn off the function from the computer to unlock the printer. After closing the door, turn on the function again from the computer.
- Stand the cassette on a flat surface as illustrated in the diagram. Avoid doing so on the floor as dust attached to it may cause printing errors.

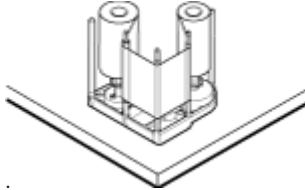

- Do not touch the retransfer face (the side that faces outward when installed) with your hand. Touching it may cause printing errors. Put on the supplied gloves when handling the retransfer film.
- The cassette is heavy when the retransfer film is loaded. To prevent the cassette from dropping during handling, make sure to hold it with both hands.
- When installing a used retransfer film, align the unused side of the film with the arrow indicated on the label of the cassette. Improper alignment may result in errors, or the print may turn out light.
- Do not perform any work on the printer door. Do not place heavy objects or apply load on the printer. Doing so may damage it.
- During replacement, clean the four bobbin holders on the printer. If burrs produced by friction with the bobbins are attached to the bobbin holders, they may fall onto the card, ink ribbon, or retransfer film, causing printing errors.

"Cleaning the bobbin holders" (page 38)

#### 1 Open the printer door



#### 2 Press and hold down the cassette button, and remove the retransfer film cassette (on the left)



#### 3 Cut away the broken portion, and attach the unused portion at the supply side to the other end at the take-up side using an adhesive tape, while making sure that the joint surface is even

#### Cautions:

- Do not discard the used retransfer film at the take-up side.

#### 4 Turn the take-up side using your hand until the broken portion can no longer be seen

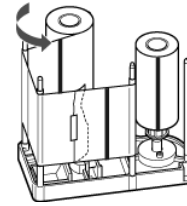

- Align the film side of the unused portion with the arrow indicated on the label of the cassette.

#### 5 Remove any slack in the film



#### 6 Insert the cassette all the way in along the guide rail until a "click" sound is heard, followed by closing the printer door

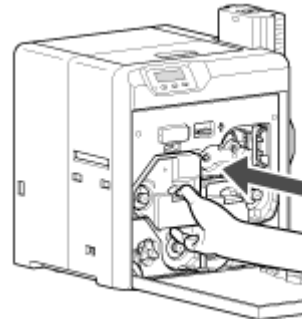
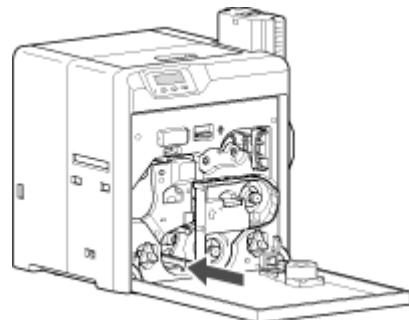

7 Press **Reset** →  to reset the printer



**Memo:**

- To avoid printing errors, it is recommended that you forward by one or two images after installing the ink ribbon cassette or retransfer film cassette.
- "Initializing printer when installing the cassette" (☞ page 21)

**Unable to Fit Retransfer Film Cassette into Printer**

- With the printer door closed, turn on the power to cancel the transport mode.
  - While in the transport mode, the retransfer film cassette cannot be installed to the printer with the retransfer film loaded.
- "Transport Mode Setting" (☞ page 27)

**Unable to Produce Desired Printing Results**

**Lines Appear on Card after Printing**

- "Clean the thermal head." (☞ page 39)

**Colors on Card Appear Faded after Printing**

- "Clean the cleaning roller." (☞ page 33)
- "Clean the fan filter." (☞ page 34)
- "Clean the card feed roller/heating roller." (☞ page 35)
- "Clean the bobbin holders." (☞ page 38)

**Peeling Occurs on Card after Printing**

- Check the retransfer mode settings.

**Overall Printing Quality is Poor**

- "Clean the cleaning roller." (☞ page 33)
- "Clean the fan filter." (☞ page 34)
- "Clean the card feed roller/heating roller." (☞ page 35)
- "Clean the bobbin holders." (☞ page 38)
- Is the printing face of the card dirty?  
Use a clean card.

**Card is Printed in a Single Color**

- Is the print setting set to single-color printing?
  - Is the software application setting set to single-color printing?
- Check the print settings.

**Strange Characters or Images are Printed**

- Is the driver for this printer selected on the computer?  
Select the driver for this printer.
- Is the USB cable connection loose?  
Plug in the USB cable properly.

**Retransfer cannot be Performed Successfully**

- Is the printing face of the card dirty?  
Use a clean card.
- Is the surrounding temperature or card surface temperature too low?  
Use the printer when the surrounding temperature is sufficiently high.
- Is the retransfer speed setting value too high?  
Set to a value that is smaller than the standard value, +2 (i.e., between +1 and -3).
- Is the temperature of the retransfer heating roller too low?  
Set to a value that is larger than the standard value, +1 (i.e., +2).

### Printer not Operating as Desired

---

#### Card is not Fed into the Printer

- Is the card load roller dirty?  
"Clean the card load roller." (☞ page 34)
- Is the cleaning roller dirty?  
"Clean the cleaning roller." (☞ page 33)
- Is the card thickness correctly adjusted?  
"Check the adjusted card thickness." (☞ page 61)
- Are the cards adhered to one another?

When using new cards, set them after making sure that they are not adhered to each other due to static.

#### Power does not Turn On

- Is the power switch turned off? (O position)  
Turn on the power. (I position)
- Is the power cord disconnected?  
Plug in the power cord properly.
- Is there electricity supply from the outlet?  
Try connecting another electrical device to the outlet. If the device works normally, then it could be due to malfunctioning of the printer. Please consult our authorized dealers.

#### Printing does not Start or Stops Halfway

- Is the printer door open?  
"Close the printer door properly, and reset the printer." (☞ page 20)
- Is the printer connected to a computer?  
Connect the printer to a computer correctly using a USB/LAN cable.
- Is the length of the USB cable too long?  
A USB cable with a length of not more than 2 m is recommended.
- Are cards set into the printer?  
"Set the cards correctly." (☞ page 29)
- Is the ink ribbon installed?  
"Install the ink ribbon correctly." (☞ page 30)
- Is the retransfer film installed?  
"Install the retransfer film correctly." (☞ page 31)
- Is the driver for this printer selected?  
Select the driver for this printer.



## Installation and Connection

### Printer Installation

#### Cautions:

- Using the printer in an environment beyond the operating ambient temperature range may result in retransfer or printing errors. Check the "Precautions on installation location" and "Operating environment conditions" specifications.

"Precautions on installation location" (page 6)

"Operating environment conditions" (page 10)

Ventilation holes for the cooling fan are located at the rear and side of the printer.

- Install the printer by allowing a clearance of at least 20 cm between its sides and surrounding walls.

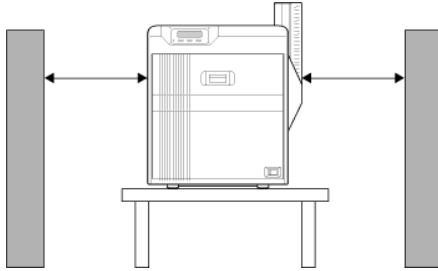

- Allow a clearance of at least 10 cm between the rear of the printer and the wall.

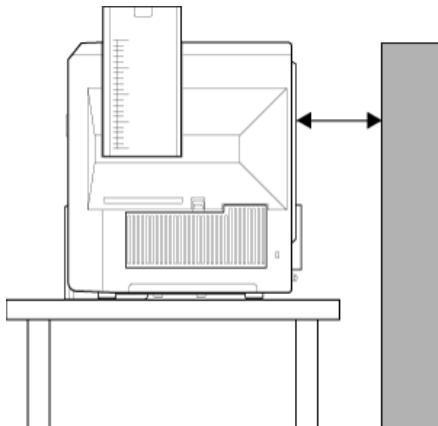

- Do not place any object on the printer.

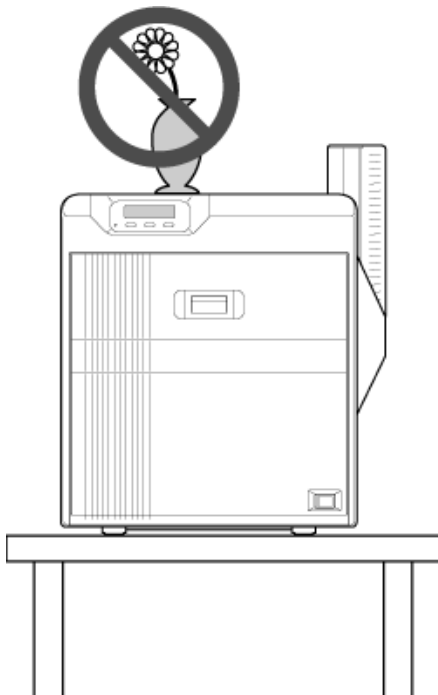

### Power Cord Connection

- Insert the power cord (supplied) to the AC inlet at the rear of the printer

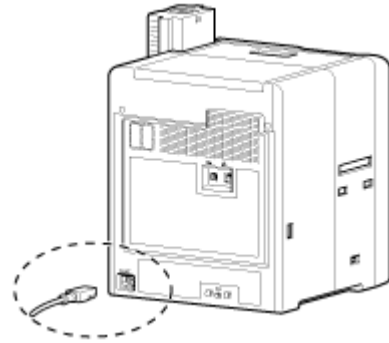

- Plug the power cord (supplied) into an outlet

#### Memo:

- Make use of an AVR (automatic voltage regulator) to prevent any fluctuation in voltage. Alternatively, an uninterruptible power supply is recommended in case momentary power failure occurs.

#### Cautions:

- Make sure that the power outlet is grounded and used as a dedicated power source for the printer.
- Plug the power cord of the printer directly to the outlet. Do not share the same outlet with other devices.

### Card Stacker (Supplied)

- Hook the tab on the card stacker to the card stacker attachment slot

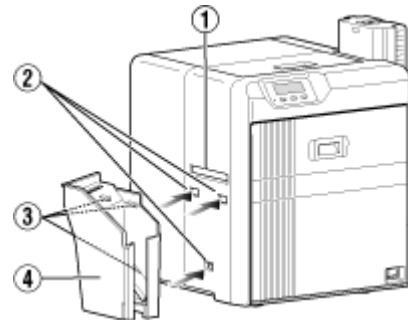

- Card outlet
- Card stacker attachment slot
- Tab
- Card stacker

#### Memo:

- The card stacker is able to store up to about 100 cards with a thickness of 0.76 mm.

## Printing Media

### Installing the Ink Ribbon

**Cautions:**

- Stand the cassette on a flat surface as illustrated in the diagram. Avoid doing so on the floor as dust attached to it may cause printing errors.

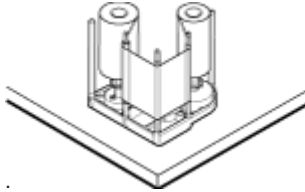

- Do not touch the inked surface (the side that faces outward when installed) with your hand. Touching it may cause printing errors. Put on the supplied gloves when handling the ink ribbon.
- The cassette is heavy when the ink ribbon is loaded. To prevent the cassette from dropping during handling, make sure to hold it with both hands.
- Do not perform any work on the printer door. Do not place heavy objects or apply load on the printer. Doing so may damage it.

**1** Open the printer door

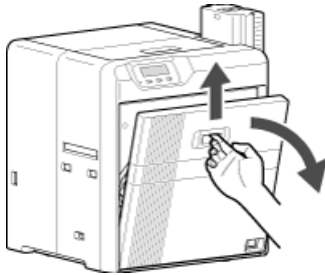

**2** Press and hold down the cassette button, and remove the ink ribbon cassette (on the right)

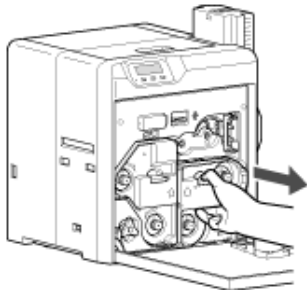

**3** Install a new ink ribbon

- Install while referring to the indication on the label of the cassette.

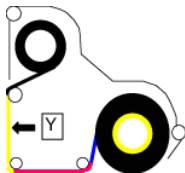

- With the inked surface facing outward, align the yellow side of the unused ribbon with the arrow on the cassette, and unwind it along the three shafts.
  - Insert the ink ribbon firmly into the bobbin holders with the ribbon set to the far end of the guides.
- A: take-up side (black)
  - B: unused side (yellow)

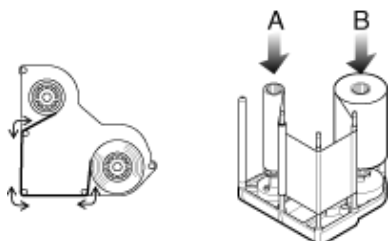

**4** Remove any slack in the ink ribbon

- Hold the cassette.
- Turn the knob in the direction indicated by the arrow.

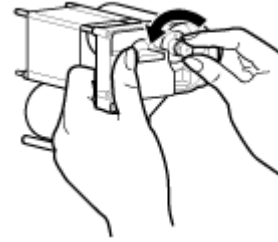

**5** Insert the cassette all the way in along the guide rail until a "click" sound is heard, followed by closing the printer door

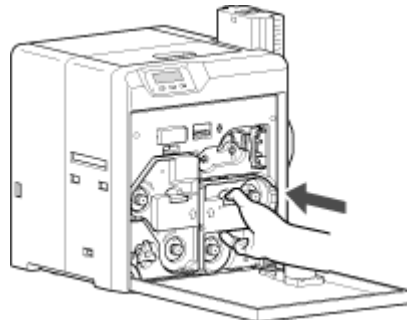
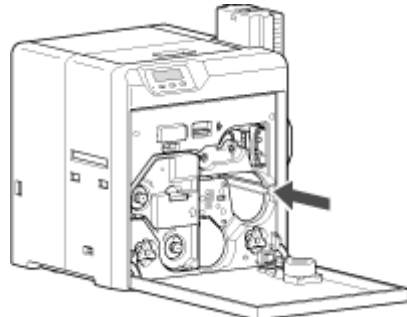

**6** Press **Reset** to reset the printer

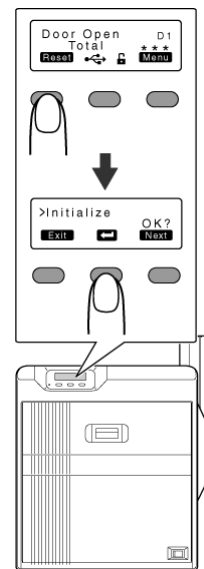

**Memo:**

- To avoid printing errors, it is recommended that you forward by one or two images after installing the ink ribbon cassette or retransfer film cassette.

"Initializing printer when installing the cassette" (page 21)

## Installing the Retransfer Film

### Cautions:

- Stand the cassette on a flat surface as illustrated in the diagram. Avoid doing so on the floor as dust attached to it may cause printing errors.

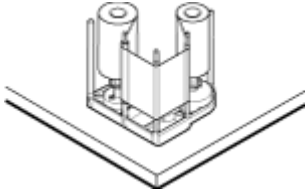

- Do not touch the retransfer face (the side that faces outward when installed) with your hand. Touching it may cause printing errors. Put on the supplied gloves when handling the retransfer film.
- The cassette is heavy when the retransfer film is loaded. To prevent the cassette from dropping during handling, make sure to hold it with both hands.
- When installing a new film, make sure that at least three black lines are wound onto the take-up side. Insufficient winding may cause the printer to malfunction.
- Do not perform any work on the printer door. Do not place heavy objects or apply load on the printer. Doing so may damage it.

### 1 Open the printer door



### 2 Press and hold down the cassette button, and remove the retransfer film cassette (on the left)

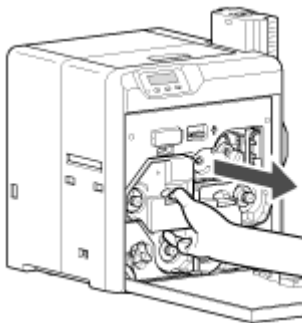

### 3 Install a new retransfer film

- Install while referring to the indication on the label of the cassette.
  - ① When installing the retransfer film, make sure that at least three black lines are wound onto the take-up side.

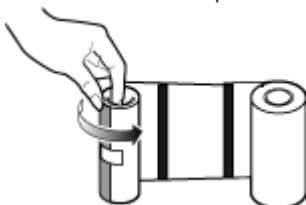

- ② With the retransfer face facing outward, align the unused side of the film with the arrow on the cassette, and unwind it along the three shafts.
- ③ Insert the retransfer film firmly into the bobbin holders with the film set to the far end of the guides.
  - A: take-up side (black)
  - B: unused side (green)

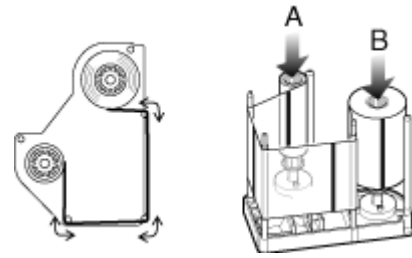

### 4 Remove any slack in the film

- ① Hold the retransfer film cassette.
- ② Turn the knob in the direction indicated by the arrow.

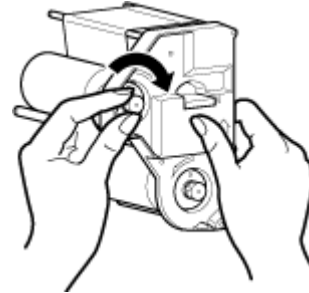

### 5 Insert the cassette all the way in along the guide rail until a "click" sound is heard, followed by closing the printer door

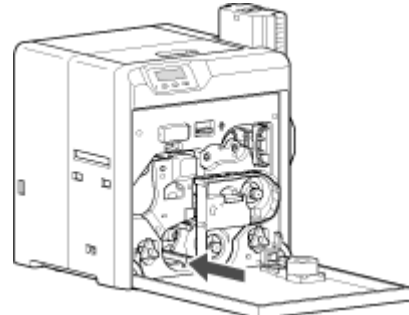

### Cautions:

- While in the transport mode, the retransfer film cassette cannot be installed to the printer with the retransfer film loaded. With the printer door closed, turn on the power to cancel the transport mode.

"Transport Mode Setting" (page 27)

6 Press **Reset**  to reset the printer



**Memo:**

- To avoid printing errors, it is recommended that you forward by one or two images after installing the ink ribbon cassette or retransfer film cassette.

"Initializing printer when installing the cassette" (☞ page 21)

## Setting Cards

- The card hopper is able to store up to about 200 cards with a thickness of 0.76 mm.

**Cautions:**

- Get ready cards that are designated by the authorized dealer.
- If the security lock function is turned on, the card hopper will be locked. Turn off the function from the computer. After loading the card, turn on the function again from the computer.
- Do not touch the printing surface of the card. Touching it may cause printing errors. Put on the supplied gloves when handling the cards.
- To prevent card jams from occurring, limit the number of cards stored in the card hopper at any time to about 100 pieces regardless of the card thickness.
- When using new cards, set them after making sure that they are not adhered to each other due to static.
- Align the cards before setting them in the printer. Otherwise, the card hopper cover may not close properly, and this may damage the printer.
- Printing the card on the side with the magnetic stripe may cause printing errors or damage to the card's functions. If you want to do so, please consult our authorized dealers in advance.
- To set cards with both functions (magnetic stripe and contact IC), follow the procedure for setting the contact IC card.

1 Set the card hopper knob to [OPEN]

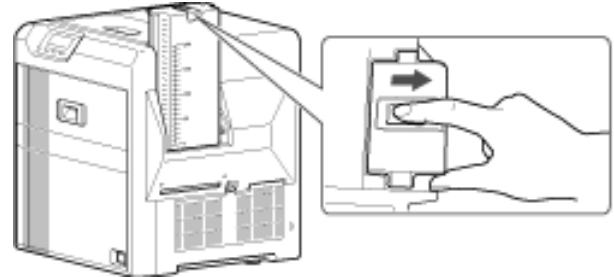

2 Lift to remove the card hopper cover

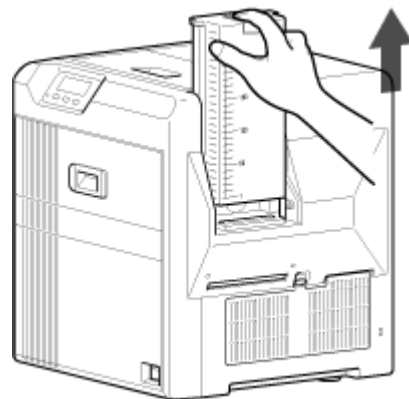

### 3 Align the orientation of the cards, and set them in the printer

#### ■ Magnetic stripe cards

- Set the card with the magnetic stripe facing upward and toward the printer, or facing downward and toward you.

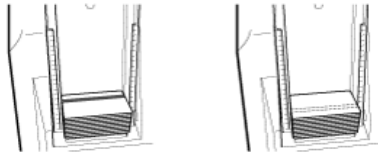

#### ■ ISO contact IC cards

- Set the card with the Contact IC terminal facing upward and toward the rear of the printer, or downward and toward the rear of the printer.
- For single-sided printers, set the cards with the IC terminal facing down and toward the rear of the printer.

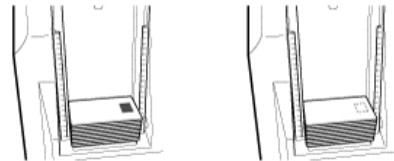

### 4 Install the card hopper cover, and set the card hopper knob to [LOCK]

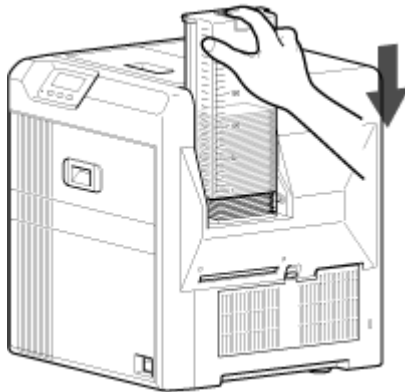

#### ■ Adjusting card thickness

- The thickness of a card which is adjustable is between 0.25 mm and 1.00 mm. Factory preset mode is adjusted approximately 0.76 mm. Please adjust thickness in accordance with the card which will be used.

##### ① Set the card hopper knob to [LOCK]

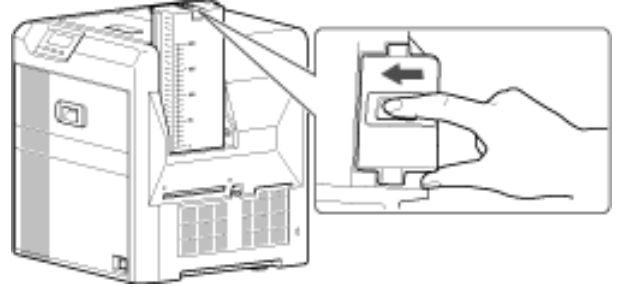

##### ② Remove the card hopper



##### ③ Insert a ballpoint pen into the card separator hole, and turn slowly

- Please adjust close to the card thickness which will be used.

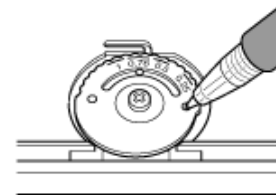

#### Memo:

- If the card cannot be discharged or get stuck during printing, adjust the card thickness by turning the card separator in the clockwise direction by one scale at a time.
- If two cards are discharged at a time during printing, adjust the card thickness by turning the card separator in the anti-clockwise direction by one scale at a time.

##### ④ Install the card hopper



## Printer and Computer Connection

### Connecting with a USB Cable

#### Cautions:

- While printing is in progress, do not turn off the power of the computer, or switch it to the sleep or standby mode. Doing so may stop the movement of the cards inside the printer.
- Plug the USB cable in correctly and firmly.
- Do not connect the cable to the USB connectors on the monitor or keyboard of the computer. The printer may not be correctly recognized.
- When using a USB hub, make use of one that is directly connected to the computer.

1 Turn off the power of the printer and computer

2 Plug the USB cable into the USB cable connection terminal at the rear of the printer, and "Cable clamp" (see page 8) pass the USB cable through the cable clamp

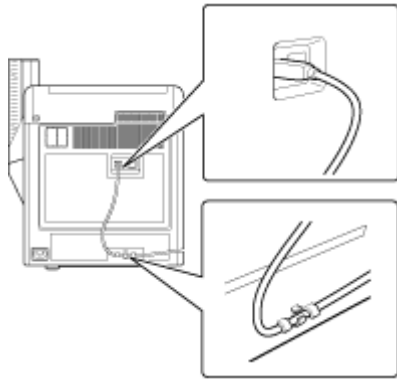

#### Cautions:

- As illustrated in the diagram, do not pull the USB cable excessively toward the cable clamp. Doing so may subject the USB connector of the printer to stress, thus resulting in connection problems.

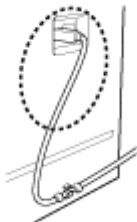

3 Plug the other end of the USB cable into the USB cable connection terminal of the computer

### Connecting with a LAN Cable

#### Cautions:

- Plug the LAN cable in correctly and firmly.
- Make use of a shielded LAN cable to avoid any malfunction.
- If a USB cable is also connected at the same time when the power is turned on, priority will be given to USB.

1 Turn off the power of the printer and computer

2 Plug the LAN cable into the LAN cable connection terminal at the rear of the printer

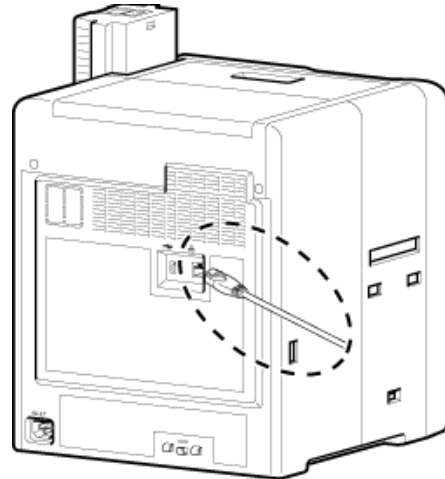

3 Plug the LAN cable into the connection terminal of the hub that is installed on the network that the computer is connected to

### Connecting Multiple Printers

- To connect multiple printer units to one computer via USB, assign a different unit number from 1 to 10 to each of the printers. "Unit Number Setting" (see page 27)
- To connect multiple printers to the same network, set a different IP address for each printer.



