

M₃SM15 Series

User Manual

Version 1.5 © 2018

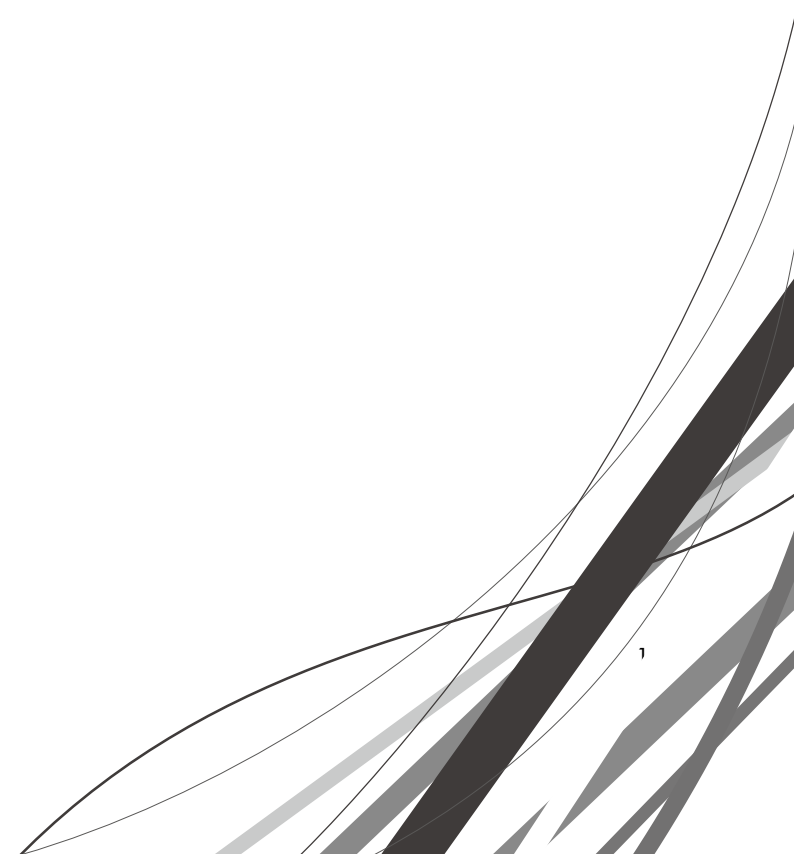

Cautions When Using This Manual

Thank you for purchasing M3 SM15. This device provides high performance data collection and mobile communications that meet industrial standards.

This user manual enables users to know the characteristics of M3 SM15 series and how to use it.

Caution

- Please carefully read this manual before using the device to ensure safe and proper use, as well as to prevent accidents that may occur when the device is used.
- This manual is created based on current status. The details on this manual may be changed without prior notice.
- The descriptions of this manual are based on the device's default settings.
- Images and screenshots are described with the latest software version.
- This manual is created under the assumption that the device has all options. For detailed information on available options, contact the local distributor or refer to our Web site (<http://www.m3mobile.net>).
- M3 Mobile does not have any legal responsibility for any performance problem that may occur when a user uses an application that is supplied by a third party.
- M3 Mobile does not have any legal responsibility for any performance degradation or compatibility problem that may occur because of the user's mistake or negligence.
- M3 Mobile does not have any legal responsibility for copyright or patent breach by the user.
- M3 Mobile can request all or part of the applications developed by a user or a third party. The request is for the improvement of user environment or device performance.
- Higher OS version may be released after you purchase the device with the existing OS. If you want to receive information on the latest OS, please contact your local distributor.
- This device can be operated in at least one Member State without infringing applicable requirements on the use of radio spectrum.
- This manual may include technical or editing errors.

Copyright

Copyright © 2018 M3 Mobile Co., Ltd.

This manual is protected under international copyright laws. No part of this manual may be reproduced, distributed, translated, or transmitted in any form or by any means, electronic or mechanical, including photocopying, recording, or storing in any information storage and retrieval system, without the prior written permission of M3 Mobile.

Trademarks

- M3 Mobile and M3 logos are registered as trademarks of M3 Mobile.
- M3 SM15 is a registered trademark of M3 Mobile Co., Ltd.

Instructional Icons

Before using this manual, please carefully read and understand the following icons:



Warning – Situations that may cause injury to yourself or others



Caution – Situations that may cause damage to your device or other equipment



Note – Notes, usage tips, or additional information

Safety Rules

- Do not use the device while driving.
 - ✓ Traffic accidents may occur.
 - ✓ Observe the rules on device use while driving.

- Do not touch the power plug with wet hands.
 - ✓ You may be electrocuted.

- Be careful when using the battery.
 - ✓ Avoid causing a strong impact on the battery or breaking a hole through it with a sharp thing.
 - ✓ Do not put water on the battery or submerge it in water.
 - ✓ Do not let the charging terminal of the battery come into contact with a metal material.

- Keep the device, battery, or charger away from direct heat sources.
 - ✓ Heat may cause the device to become deformed, or an explosion or fire may occur.
 - ✓ If the device is placed inside a vehicle, the battery may explode due to increase in temperature.

- Do not use the device when there is thunder or lightning.
 - ✓ Lightning or fire may cause the device to break down or you may be electrocuted.

- Turn off power of the device when device use is prohibited.
 - ✓ Hazardous or wave-related problem may occur.
 - ✓ Turn off power of the device when you board a plane. The electromagnetic waves generated from the device may affect the plane's electronic equipment.
 - ✓ Turn off power of the device when you are in a hospital. Observe the device rules while in a hospital. The electromagnetic waves generated from the device may affect the medical equipment in the hospital.

- Turn off power of the device in hazardous areas where explosions may occur.
 - ✓ Observe the regulations, instructions, or signs of a hazardous area where explosions may

occur.

- ✓ Turn off power of the device while refueling.
- Be careful when a headset is used.
 - ✓ Avoid long-term exposure to loud sounds to prevent damage to your hearing.
 - ✓ Loud sounds while walking or driving distract your attention and may cause traffic accidents.

Revision

Release date of version 1.0: June. 2017

- Initial distribution

Release date of version 1.1: Dec. 2017

- Update pictures

Release date of version 1.2: Jan. 2018

- Update New Functions.

Release date of version 1.3: Feb. 2018

- Update pictures, Add Korean language version

Release date of version 1.4: March. 2018

- Revise Tables and Contents

Release date of version 1.5: April. 2018

- Revise Tables and Contents

Table of Contents

Cautions When Using This Manual.....	2
Caution	2
Copyright	3
Trademarks	3
Instructional Icons	3
Safety Rules.....	4
Revision	5
Table of Contents.....	6
1. Getting Started	9
1.1 Package Contents	9
1.1.1 Device and Accessories	9
1.2 Battery	11
1.2.1 How to Use.....	11
1.2.2 Charging the Battery	12
1.3 Turning the Device On/Off	14
1.3.1 Turning the Device On	14
1.3.2 Turning the Device Off	15
1.3.3 Standby Mode	15
1.4 Memory Card	16
1.4.1 Inserting an External Memory Card	16
1.4.2 Checking Data	17
1.5 SIM Card	18
1.5.1 Inserting the SIM Card	18
2. Basic Use	19
2.1 Features.....	19
2.2 Key	20
2.2.1 Button	20

2.3	Home Screen.....	20
2.3.1	Status Bar	21
2.3.2	Notification Bar	21
2.3.3	Home Screen.....	22
2.3.4	Dock Bar.....	22
2.4	Data Input.....	23
2.4.1	Virtual Keyboard	23
2.5	Device Reset	23
2.5.1	Soft Reset (1).....	23
2.5.2	Soft Reset (2).....	24
2.5.3	Factory Reset.....	24
	How does FRP work?	26
	What do I need to know about FRP?.....	26
2.6	Connecting with a PC	27
2.6.1	How to Connect	27
3.	Using the Application Screen	29
3.1	Phone Function	29
3.1.1	Basics	29
3.2	Wi-Fi.....	30
3.2.1	Setting the Wi-Fi Feature	30
3.3	Scanner.....	31
3.3.1	How to Use Scanner	31
3.3.2	Using the Scanner.....	32
3.4	Bluetooth.....	33
3.4.1	Setting the Bluetooth Feature	33
3.4.2	Connecting Using Bluetooth	33
3.5	NFC	35
3.5.1	Setting the NFC Feature	35
3.5.2	Connecting the NFC Feature	36
4.	Advanced Use.....	38
4.1	OS Update	38

4.2	Key Setting Conversion	40
4.3	Battery Hot swap.....	41
4.4	Fast Charging.....	44
5.	Others.	46
5.1	SM15X Device Specifications.....	46
5.2	SM15N Device Specifications	47
5.3	SM15W Device Specifications	48
5.4	Service.....	49
5.4.1	Contacts.....	49

1. Getting Started

1.1 Package Contents

1.1.1 Device and Accessories

The **M3 SM15** package includes the following items:

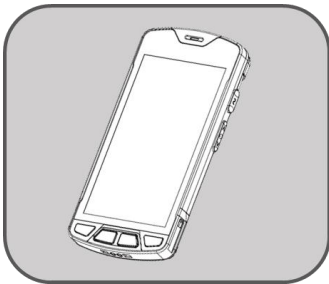

<M3 SM15>

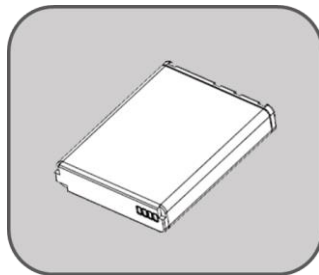

<Battery>

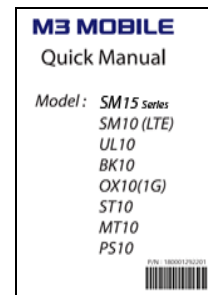

<Quick Manual >

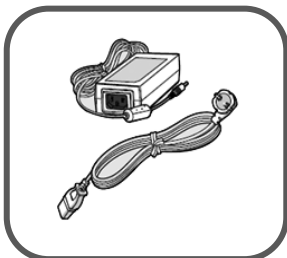

<Adapter>

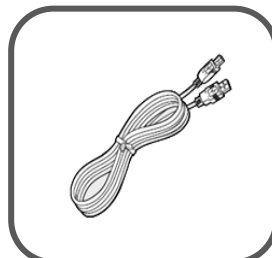

<USB Cable>

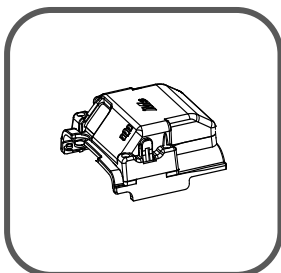

<Snap-on>

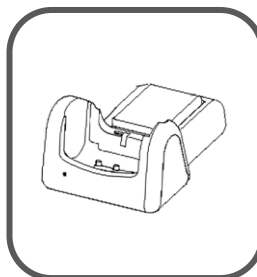

<Charging Cradle>

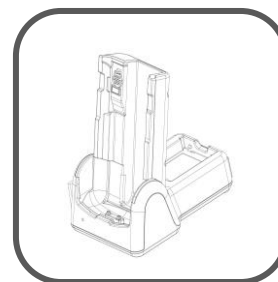

<Ethernet Cradle>

If one or more items above are damaged or are not included in the package, contact the store where you purchased the device. (Only one package is provided to one device.)

※ NOTE

For data synchronization, either Cradle or Snap-on can be provided depending on your purchasing option.



If the device is used for purposes other than the original device use or if it is remodeled, you may be exposed to electromagnetic waves.

1.2 Battery

1.2.1 How to Use

Inserting the Battery

- Insert the battery from the bottom in the right direction.
- After inserting the battery, slide the Slide button to the left to fix the locking device.

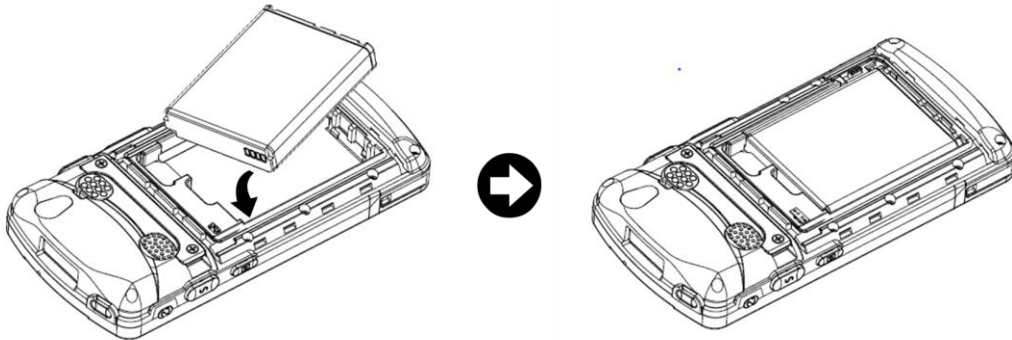

M3 SM15 uses 3.8 V  4,100mAh or 6,150 mAh Li-ion Battery.



- If an unapproved battery is used, it may explode.
- When a battery is discarded, follow proper disposal procedure.
- Check if the battery is inserted in right direction.

Removing the Battery

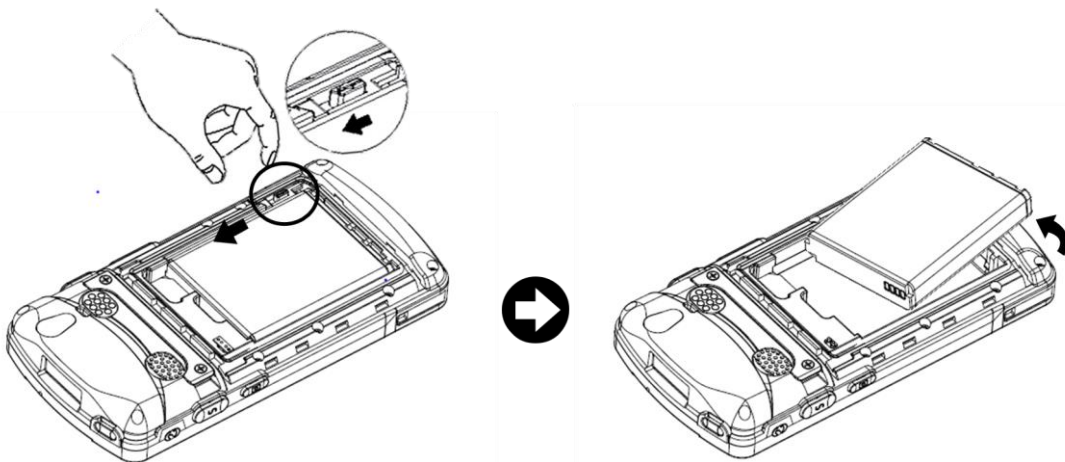



If the battery is not properly removed, the battery terminal may become bent or damaged.

Before the battery is removed, close any running program. If it is not closed, an error may occur in the program.

Before the battery is removed, Save the data being used.



M3 SM15 can be used for up to 10 hours after the battery is fully charged.

(The maximum time of using device depends on usage environment of a user.)

1.2.2 Charging the Battery

If the following battery warning screen is displayed, charge the battery.

If the device is continuously used without charging the battery, its power will be turned off.

Charging the Battery

- Please connect the device to a cradle that you can additionally purchase to charge the battery.
- As pictures below, Charging begins when you set a device into the cradle.

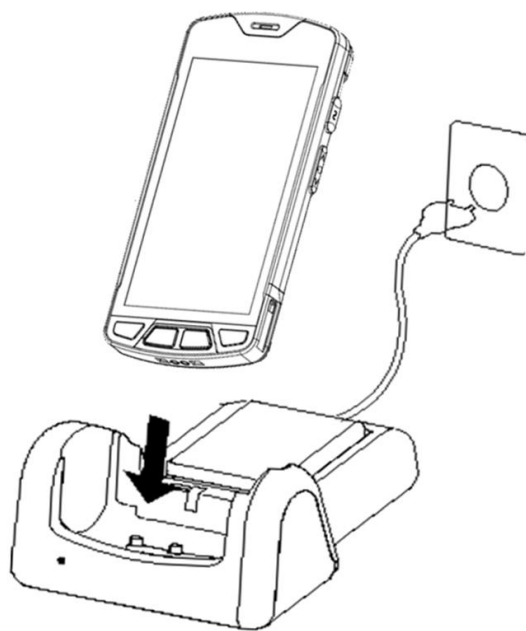



AC adaptor is made to be used in 100–240V input, 5V \equiv 4A output. If a voltage beyond the range is supplied, the device may be seriously damaged.

LED Color	Description
Red	Battery is being charged.
Green	Battery is fully charged.



If the battery is used at the temperature other than -20°C (-4°F) – 60°C (140°F), the device may malfunction or break down.

It takes about 4–5 hours to fully charge a battery that is fully discharged.



- It is recommended to replace a battery every two year.
- If a battery is charged and used continuously, its lifespan will decrease.



For information on the device battery, **Swipe the bottom** → **Click**  **Settings** → **Battery**.

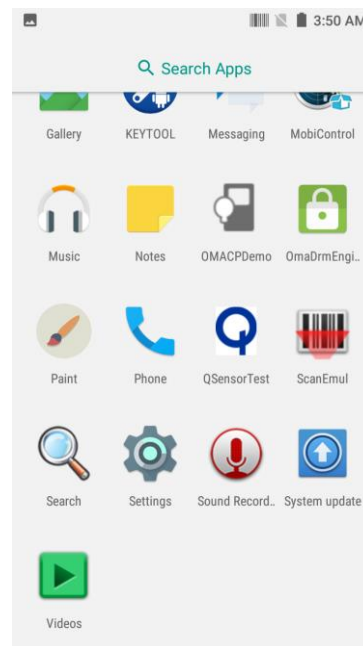
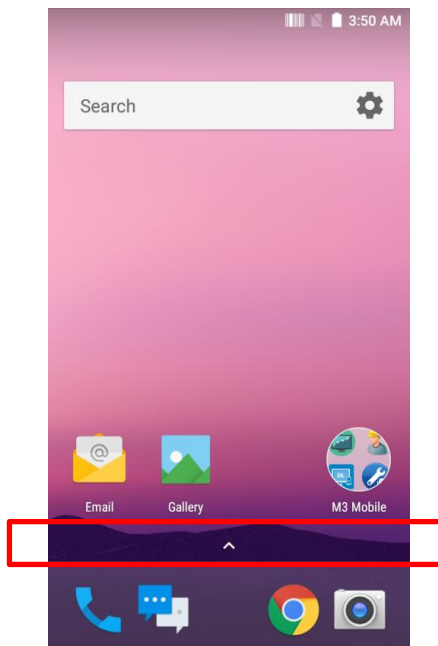

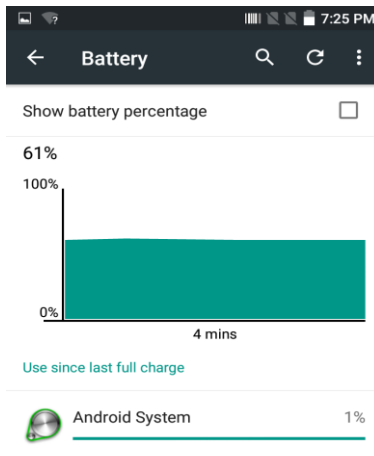
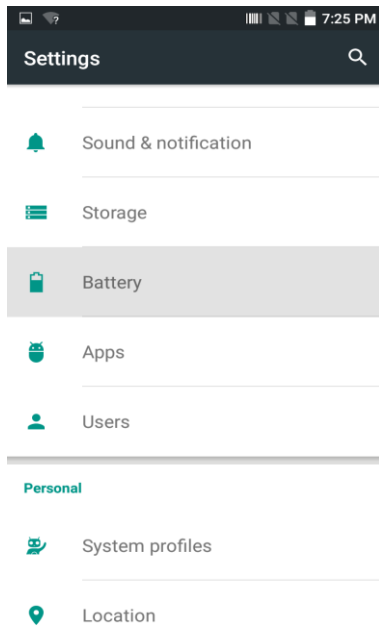

1.3 Turning the Device On/Off

1.3.1 Turning the Device On

Press and hold Power button until the device vibrates. This will turn the device on and initial screen will display.



If the battery is completely discharged, problems may occur when the device is turned on. If a problem occurs, charge the battery before turning on the device again.

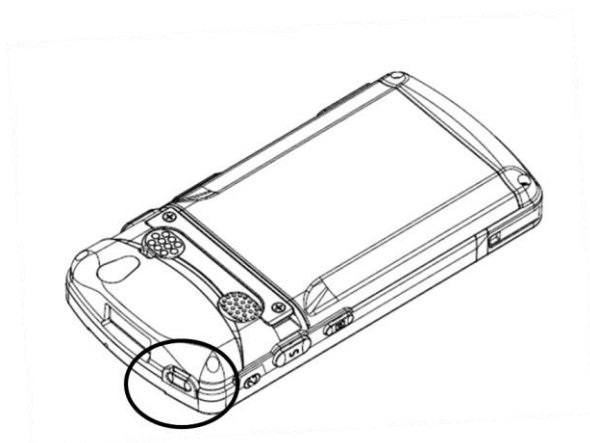

1.3.2 Turning the Device Off

Press and hold the Power button for about one second to display the following pop-up screen. Select the Power off menu to turn off the power.

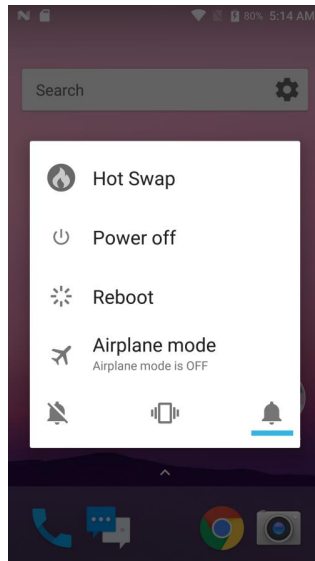

If the device stops its operation for a long time, press and hold the Power button for about eight seconds to forcibly turn the device off.

1.3.3 Standby Mode

If the device is not used for a long time, M3 SM15 automatically shifts to standby mode to decrease battery consumption. To manually set the device in standby mode, lightly press the Power button. By default, if the device is not used for one minute or longer, it shifts to standby mode. The time when the device shifts to standby mode can be set by the user.



Swipe the bottom → Click  **Settings → Display → Sleep** to change time that the device will shift to standby mode.

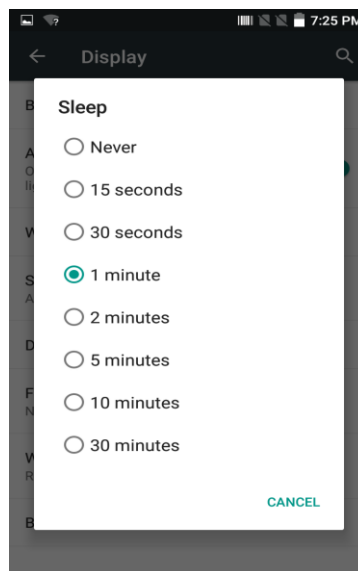
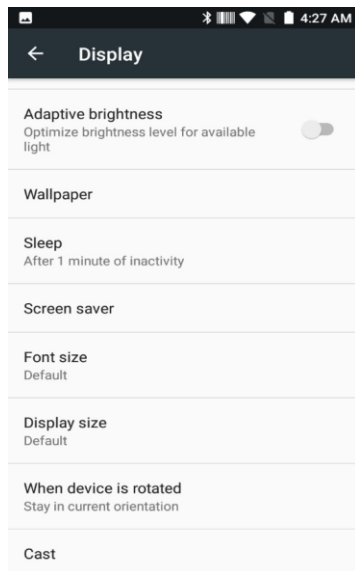
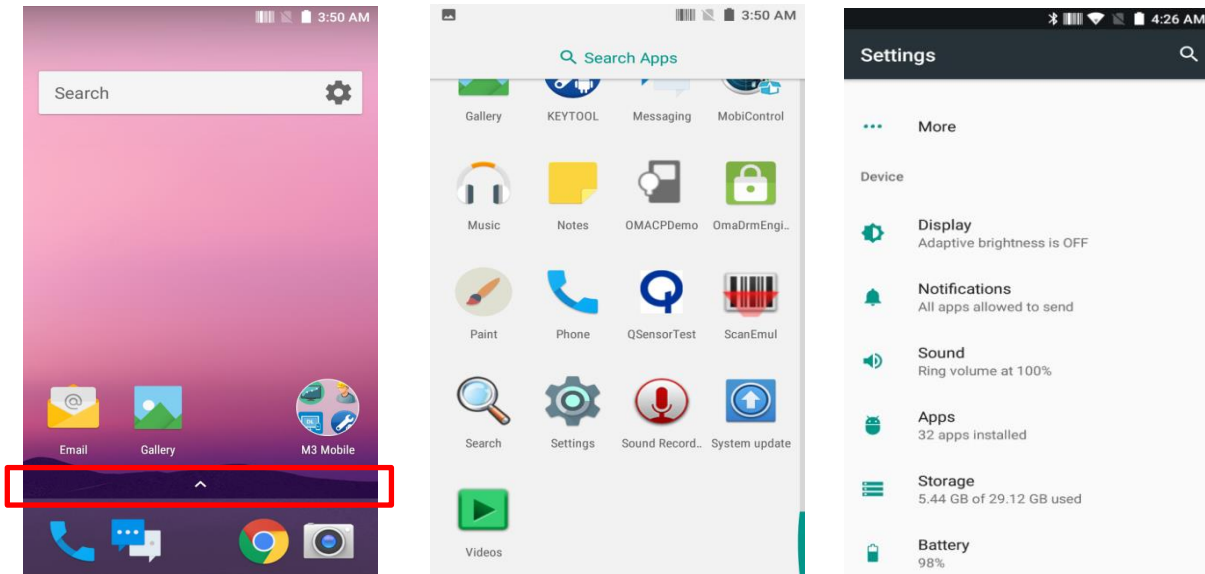

1.4 Memory Card

1.4.1 Inserting an External Memory Card

The Micro-SD card is used as an external memory of M3 SM15. After removing the battery, insert SD memory card into the Micro-SD card slot.

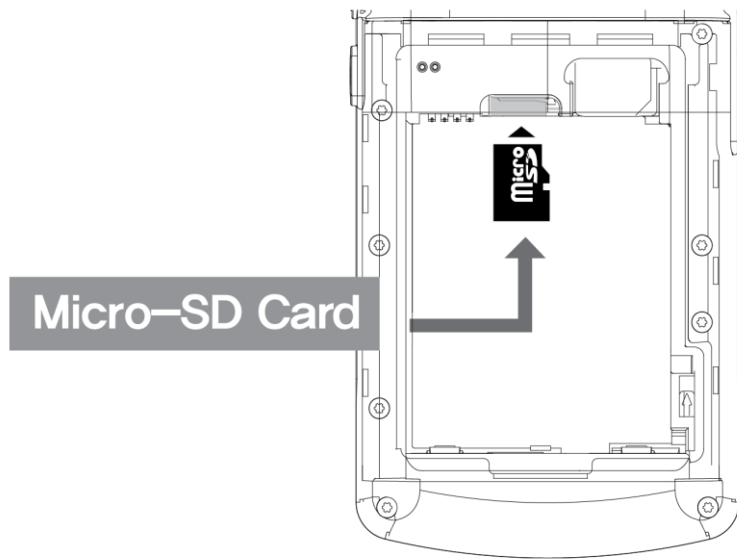

To insert Micro-SD card, Remove battery cover on the rear of the device and pull out the battery.



- *Android 7.0 (NOUGAT), the OS used in M3 SM15, can support up to 128 GB for external memory.*

1.4.2 Checking Data

Information stored in the Micro-SD card can be checked by **swiping bottom** → Click  **File**

Manager → **Storage**

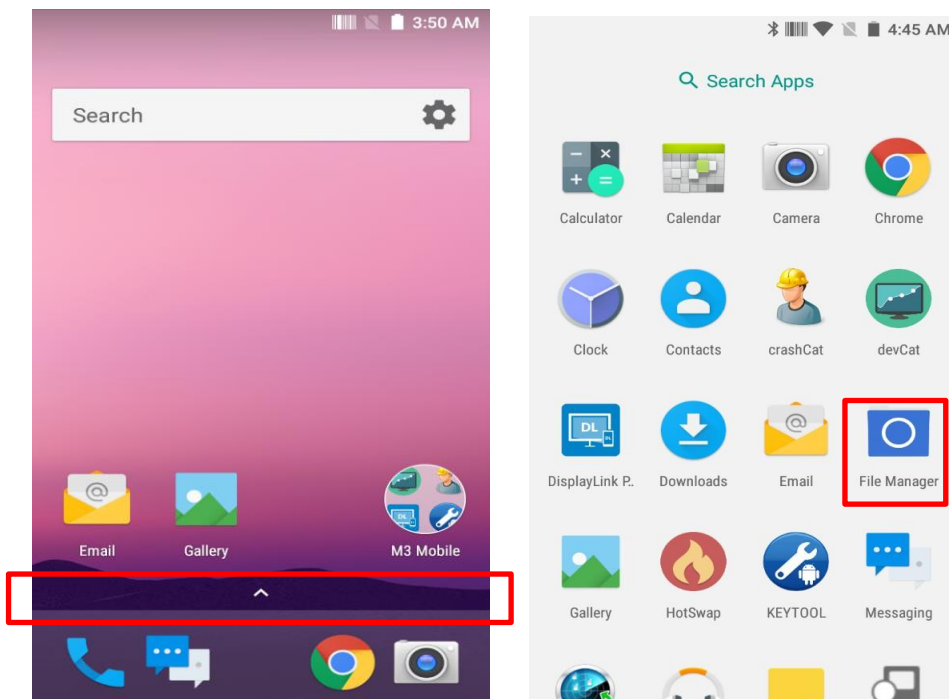

1.5 SIM Card

1.5.1 Inserting the SIM Card

SIM card supports voice call and data transfer through mobile communications. The card should be the one verified by a local network supplier.

To insert SIM card, Remove battery cover on the rear of the device and pull out the battery. Either the front or back of the SIM card can be connected to dual slot.

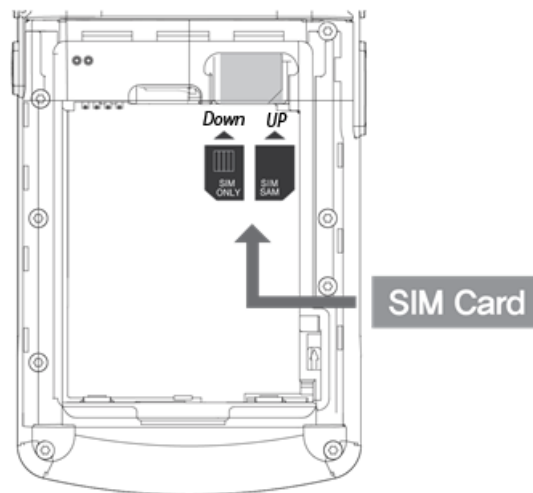

For more information on how to use the phone, please see [phone section](#).

2. Basic Use

2.1 Features

Device Layout

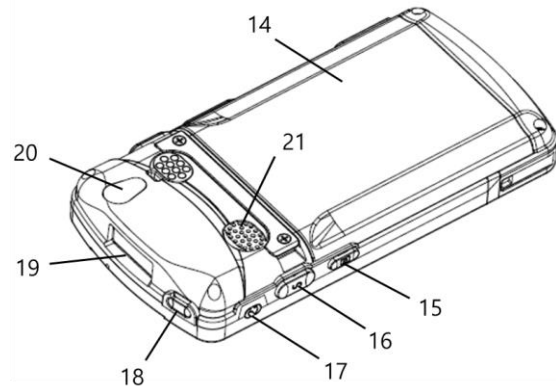
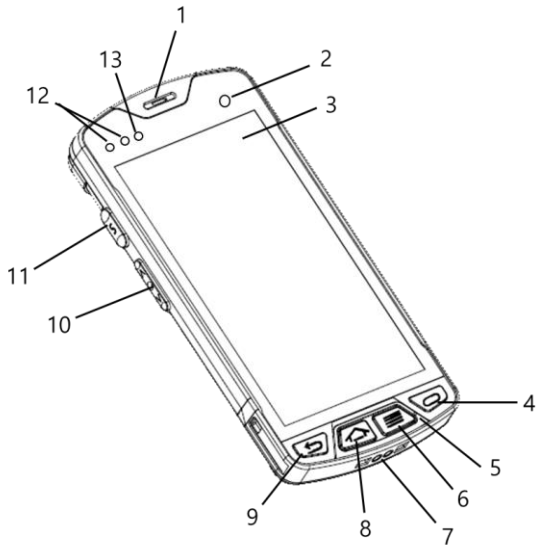

- | | | |
|----------------------|--------------------|-------------------|
| 1. Receiver | 9. Back Button | 17. Ear Jack Hole |
| 2. Camera | 10. Volume Button | 18. Power Button |
| 3. Screen | 11. Scanner Button | 19. Scan Window |
| 4. Function Button | 12. Sensor | 20. Camera |
| 5. Microphone | 13. Charging LED | 21. Speaker |
| 6. Menu Button | 14. Battery Cover | |
| 7. Charging Contacts | 15. Camera Button | |
| 8. Home Button | 16. Scanner Button | |

2.2 Key

2.2.1 Button

Button	Description
Scanner	Operate scanner while executing scanner program.
Volume High	Increase volume.
Volume Low	Decrease volume.
Camera	Take pictures while executing camera program.
Back	Return to previous stage.
Home	Go to Home screen.
Menu	Display menu.
Function	Execute the work set to the button.









2.3 Home Screen

If the device is turned on, the following screen will be displayed. The screen is divided into four sections as follows:

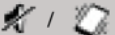
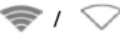







2.3.1 Status Bar











The Status Bar displays status of the device.

Icon	Icon Name	Description
	Battery	Battery charging status or battery residual capacity
	Phone	Call strength or no signal
	Sound / Vibration	Sound or Vibration status of the device
	Wi-Fi	Wi-Fi connection/disconnection
	Bluetooth	Bluetooth connection/disconnection
	GPS	Status of searching the location data
	Alarm	Alarm activation status
	Flight Mode	Activation status of Flight mode
	NO SIM	SIM card is not connected
	3G Network	3G network connection status

2.3.2 Notification Bar









The Notification Bar displays device notifications.

Icon	Icon Name	Description
	More	There are more notifications.
	Data Sync	Data is being synchronized.
	Schedule	Displays the schedule.
	Wi-Fi	Open Wi-Fi network can be used.
	Music	Music is being played.
	Data Sync	An error occurs when data is being synchronized.
	Data Upload	Data is being uploaded.

	Data Download	Data is being downloaded.
	SD Card Full	Capacity of SD card is full.
	USB	Device is connected through USB.
	Debugging	USB debugging can be used.
	Received Message	There is a message received.
	Missed Call	There is a missed call.
	Wi-Fi hotspot	Wi-Fi hotspot is activated.
	USB tethering	USB tethering is activated.
	Bluetooth tethering	Bluetooth tethering is activated.
	Virtual Private Network	Device is connected to Virtual Private Network(VPN).

2.3.3 Home Screen





On the Home Screen, there are shortcut icons of main programs. A shortcut icon can be added or deleted.

Icon	Icon Name	Description
	Setting	Set M3 SM15.
	E-mail	Send or receive an e-mail.
	Play Store	Run Play Store.
	Calendar	Set, manage, or reserve a schedule.
	Camera	Take a picture or record a video.
	Gallery	Display stored photos.
	Music	Play stored music.
	Video	Play stored videos.

2.3.4 Dock Bar

Shortcut icons can be placed on the lower section to rapidly execute frequently used programs.

On the Dock Bar, up to four shortcut icons may be added or deleted.

Icon	Icon Name	Description
	Phone	Receive or make a call.
	Address Book	Manage address book.
	Message	Receive or send a text message.
	Internet	Enable Internet

2.4 Data Input

2.4.1 Virtual Keyboard

If focus is located in the input screen, the virtual keyboard will be automatically displayed.

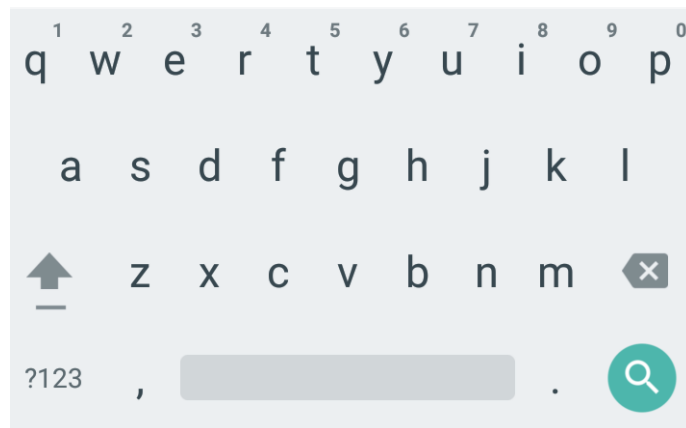

2.5 Device Reset

2.5.1 Soft Reset (1)

Press and hold Power button to display power management menu. Select "Power Off" menu.

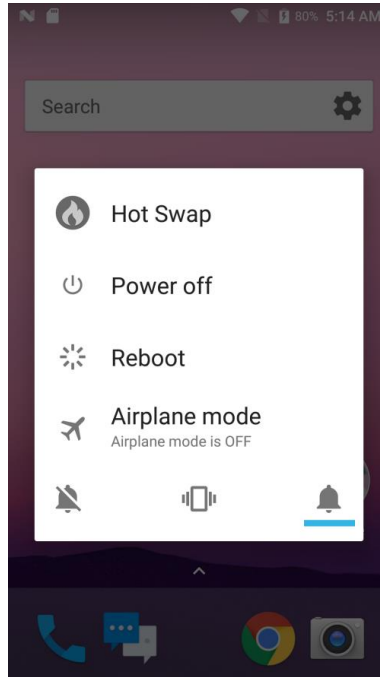

2.5.2 Soft Reset (2)

Long Press Power button more than 30sec.

The program being executed will end, and the data or file being used will also be deleted.

However, the stored data or file will not be affected by Soft Reset.

2.5.3 Factory Reset

If serious problem occurs in the device or problem is not solved through Soft Reset, Perform factory reset.

For factory reset, Perform the following procedure:

- **Swipe the bottom → Click  Settings → Backup & Reset → Factory data reset**

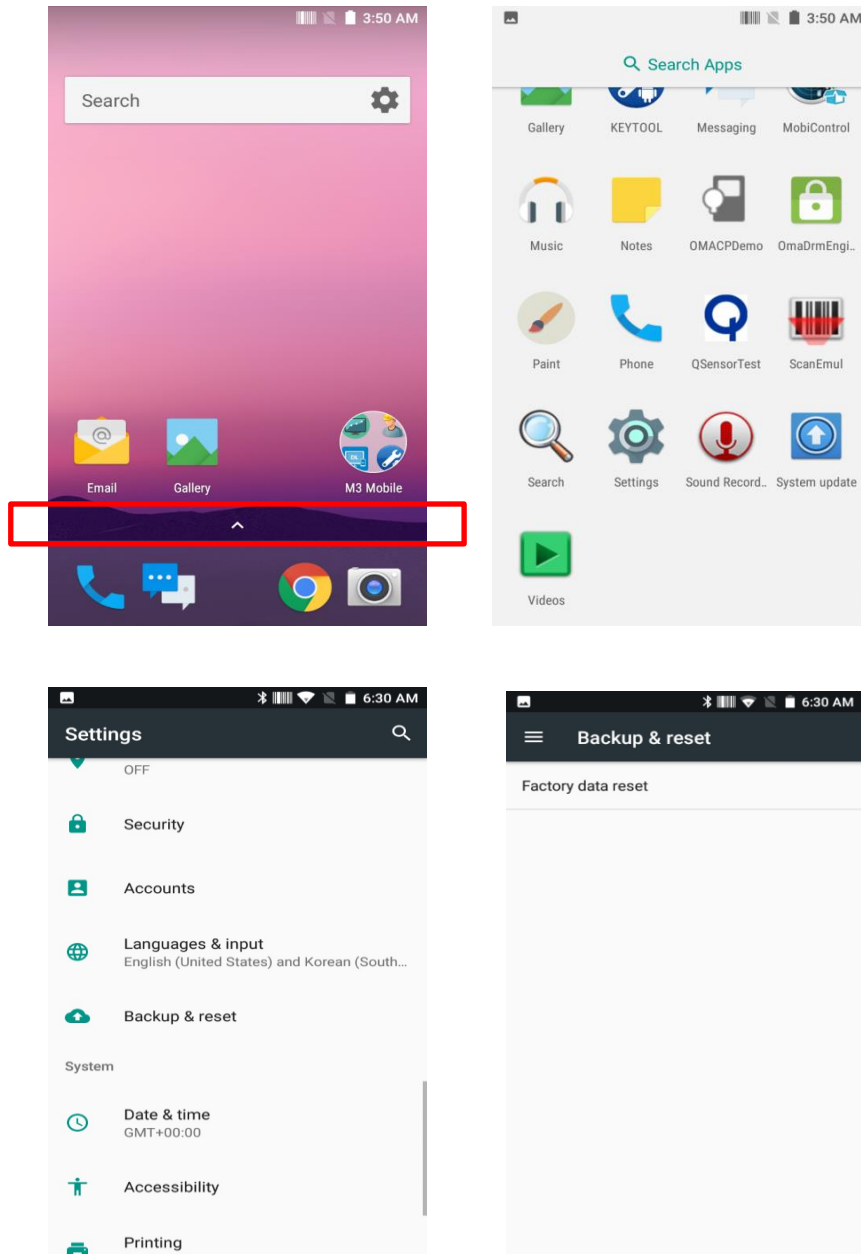

- **Check if Erase internal SD card is checked. → Reset device. → Erase everything**
- According to options, documents in internal SD card or Micro-SD card may be deleted. As such, please check the options. All settings will be reset.

Factory Reset Protection (FRP) Feature

What is Device Protection, or Factory Reset Protection (FRP)?

Android devices provide built-in security features you can use to protect your device and information, including screen locks and data encryption. Data protection, or Factory Reset

Protection (FRP), is a security feature on Android devices with Lollipop 5.1 or higher.

FRP is automatically activated when you set up Google Account on your device. Once FRP is activated, it prevents use of a device after factory data reset, until you log-in using Google username and password previously set up on the device.

How does FRP work?

When you perform a Factory Data Reset, all settings are returned to the factory default settings. All data is erased including files and downloaded apps.

If you have a Google Account set up on the device, FRP is active. This means that after reset, you'll be required to log-in to the Google Account using the username and password. If you have multiple Google Accounts set up on the device, you can log-in using any of the accounts.

If an unauthorized person tries to reset the device by another method, the device would still require log-in using the Google username and password. This means that if your device is lost or stolen, another person would not be able to reset it and use it.

What do I need to know about FRP?

If you want to reset your device to factory defaults, make sure you know your Google Account and password, because you'll need to log-in at the end of the reset.

If you want to reset your device to factory defaults, but don't remember your Google username and/or password, you can do one of these:

- Check your device's Account settings for your account name and reset your password via the device or at www.google.com.

It can take 24 hours for the password reset to sync with all devices registered to the account.

- Remove the account before you reset device.

If you already reset your device, but don't remember your Google username and/or password, the device can't be used. In that case, you can do one of these:

- If you know your Google username but can't remember the password, you can reset your password on the device, or at www.google.com. It can take up to 24 hours for a new password to sync with all registered devices. After 24 hours, you can try to log-in your phone with the new password.

If you have multiple Google Accounts, and you can't remember which Google Account you set up on your device, visit <https://www.google.com/android/devicemanager>.

Log in with your Google username and password and check the list of devices registered to the account. If you don't see the device listed on the account, it means the device is registered to a different account. Use the same process to check for devices linked to your other Google Accounts. When you find the registered account, use it to log-in your device.

If you can't remember any of your Google Account information, you can send your device, along with proof of purchase, to an authorized M3Mobile supplier. M3 has special tools to reset the phone to factory defaults with no protection enabled.

2.6 Connecting with a PC

2.6.1 How to Connect

To connect the device to a PC, perform the following procedure:

1. Connect the device to a PC via Ethernet cradle or Snap-on.

You'll see screen as below.

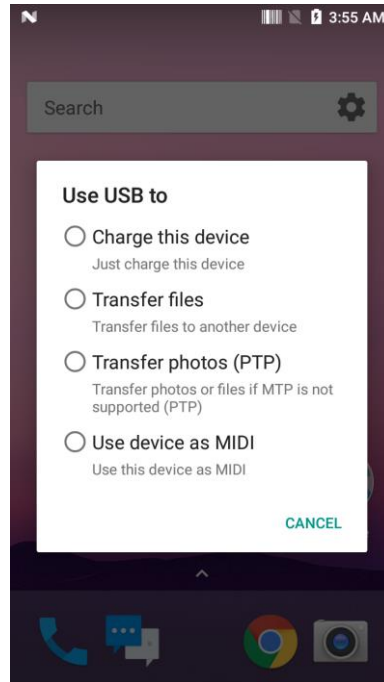

- Charge this device – This mode is only for charging a device. Data cannot be sent.
- Transfer files – Send files to another device.
- Transfer photos (PTP) – Send photos or files.
- Use device as MIDI – Use as Musical Instruments App.

2. PC recognizes the device and automatically installs driver.
3. Once the driver is completely installed, file is transferred through Explorer.

If the device does not connect with a PC, check the following:



- Check if the USB cable is properly connected between the device and PC.
- Check if LCD screen of the device is turned on.

Check above and connect them again.

3. Using the Application Screen

3.1 Phone Function

M3 SM15 supports the 2G (GSM, CDMA), 3G (UMTS, HSPA+) and 4G (LTE) networks.

3.1.1 Basics

Press the  icon to use the Phone menu.

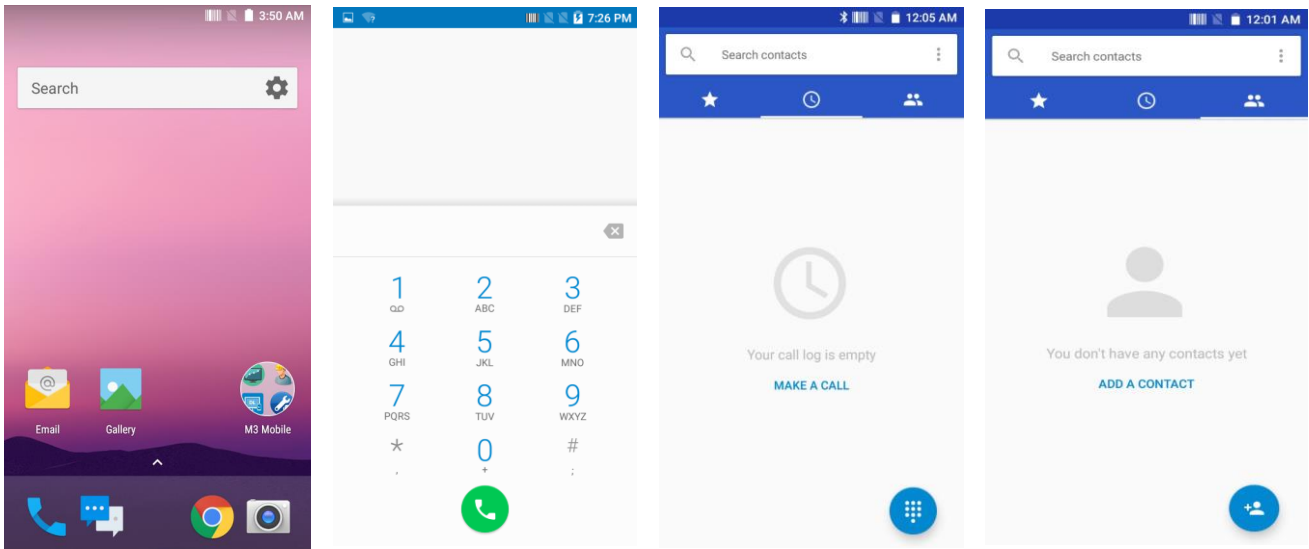

- Press the () icon to see the recent call history.

- Press the () icon to see the contacts.

- Press the () icon to add a contact.



Before making a call or transferring data through network, Check if phone function is turned on.

3.2 Wi-Fi

3.2.1 Setting the Wi-Fi Feature

Activating the Wi-Fi feature

Swipe the bottom → Click  **Settings** and set the **WLAN** menu to ON/OFF to activate or deactivate the Wi-Fi feature.

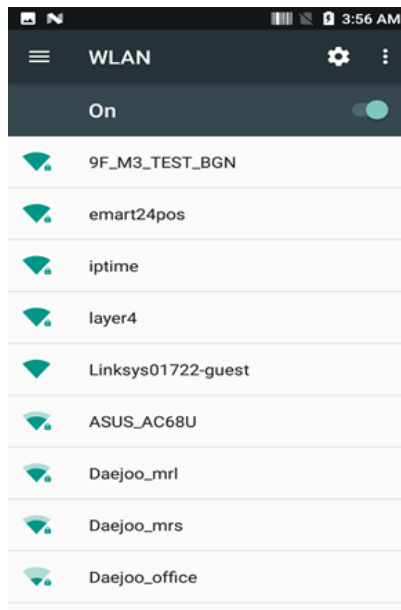
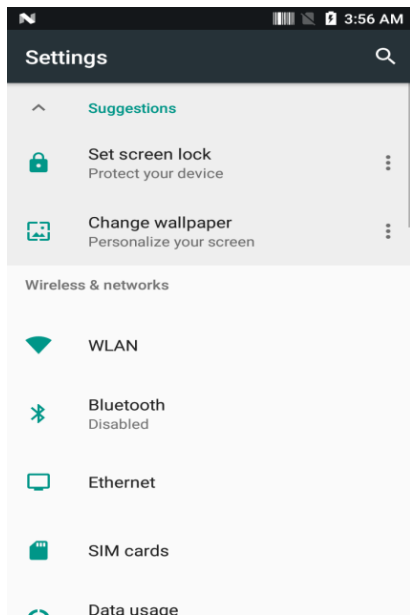
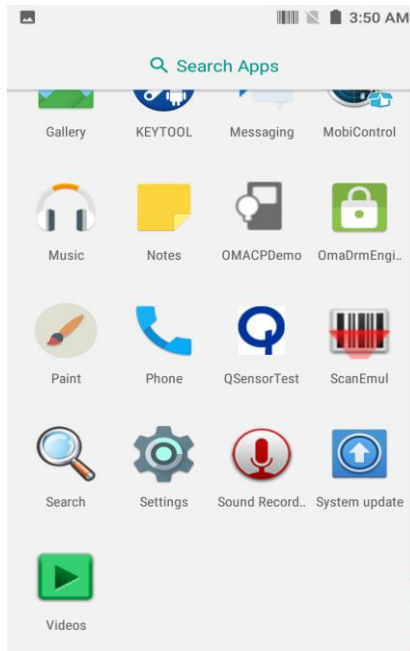
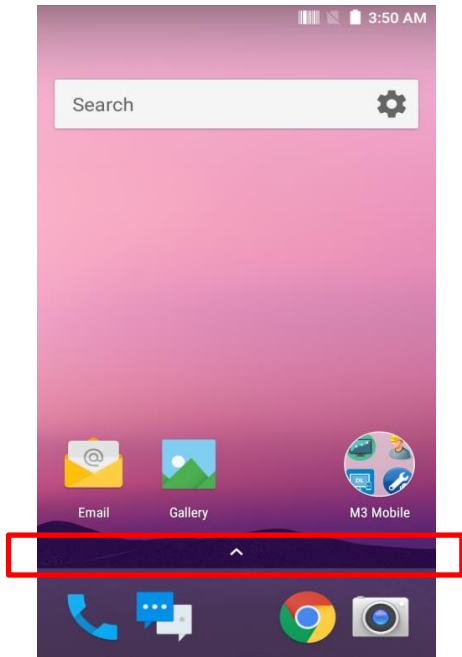

Connecting to a Wi-Fi network

To connect to an AP, perform the following procedure:

- i. Select **WLAN** menu of the  **Settings** icon.
- ii. In the list, select an AP name to access.

If necessary, Enter password to complete the access.

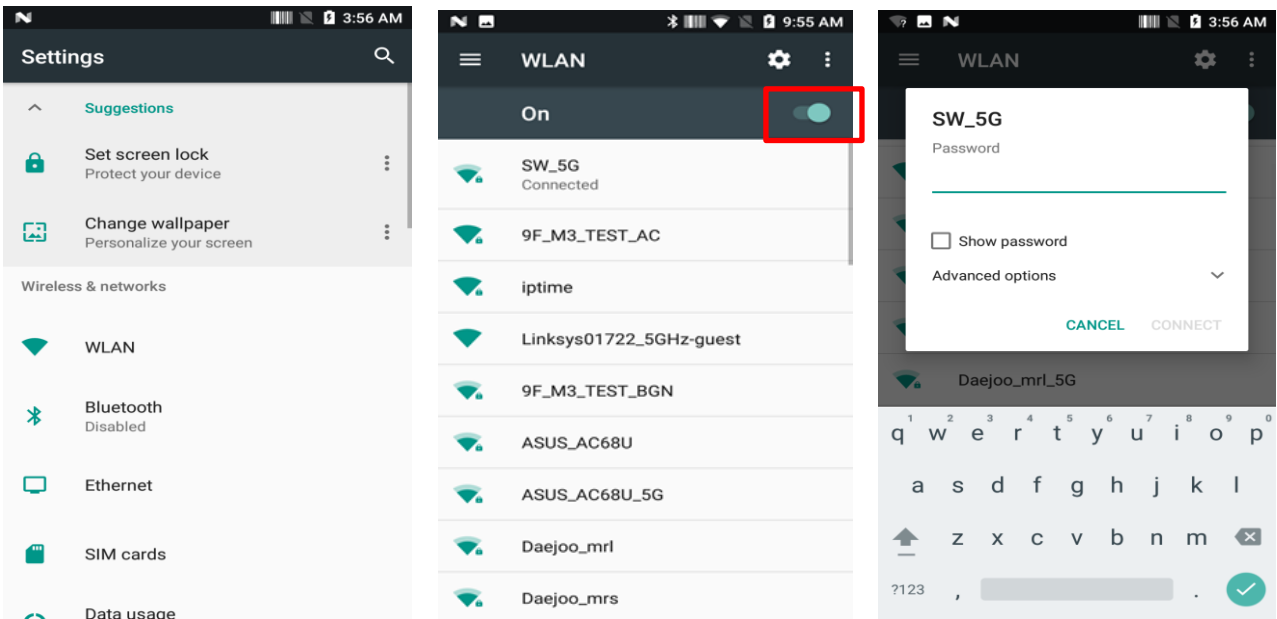

3.3 Scanner

M3 SM15 provides 1D or 2D scanner as an option. For detailed information on available options, please contact the local distributor or refer to our Web site.

(Homepage: <http://www.m3mobile.net>).

3.3.1 How to Use Scanner

M3 Mobile provides the program needed to use a scanner by default.



It is the keyboard wedge program that sends barcode data.

The ScanEmul program can be used regardless of 1D/2D scanner.



In case of 2D scanner, it cannot be simultaneously used with a camera.

3.3.2 Using the Scanner

Place the device toward a targeted barcode and press Scan button.

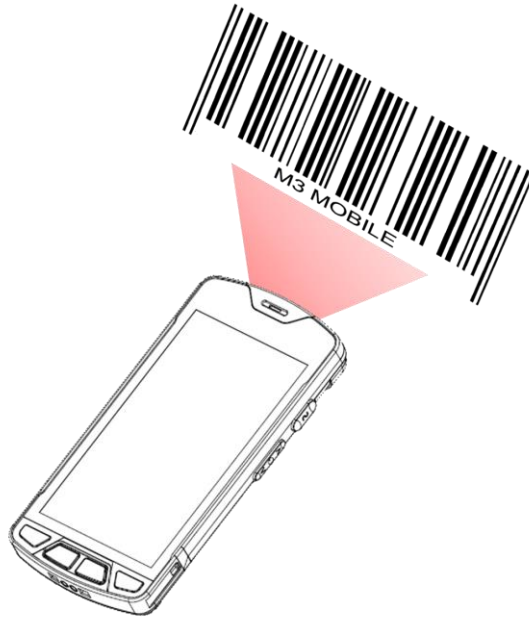

The laser beam of the scanner should completely cover barcode as shown in the following.



O



X

<1D Scanner>



O



X

<2D Scanner>



1. Do not look at the laser beam directly.
(CLASS 2 LASER PRODUCT 1.0 mW, MAX OUTPUT: 650 nm)
2. If the device is used for purposes other than that described in this manual, a user may be exposed to harmful electromagnetic waves.

3.4 Bluetooth

3.4.1 Setting the Bluetooth Feature

A Bluetooth device frequently used can be registered, or M3 SM15 can be searched in another device.

Activating the Bluetooth feature

Click  **Settings** and set the **Bluetooth** tab to ON/OFF to activate or deactivate Bluetooth feature. If Bluetooth signal is turned on, Bluetooth icon () is displayed in the Status bar indicating that the Bluetooth feature is activated.

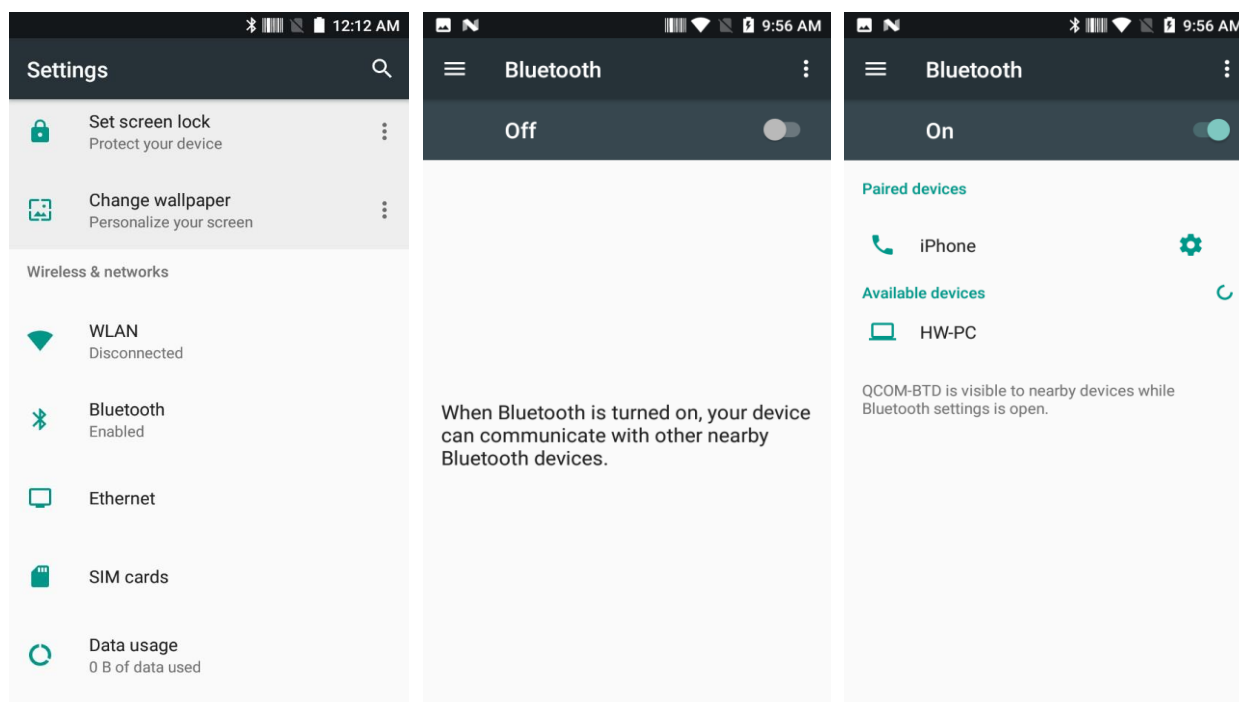

3.4.2 Connecting Using Bluetooth

Connecting Using Bluetooth

To connect using Bluetooth, Click  **Settings** → **Bluetooth**.

To activate the Bluetooth feature, select the **Bluetooth** tab of the  icon.
Connect M3 SM15 with a Bluetooth device to share information via wireless connection.

1. Tap  → **Bluetooth** → **Search the Devices** to search a device to connect.

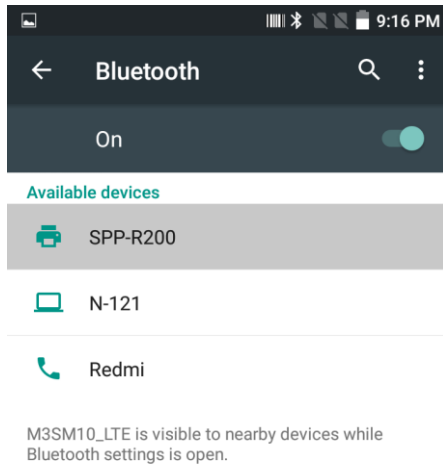

If the **"Bluetooth pairing request"** screen is displayed, enter PIN code of the Bluetooth device to complete access to the device.

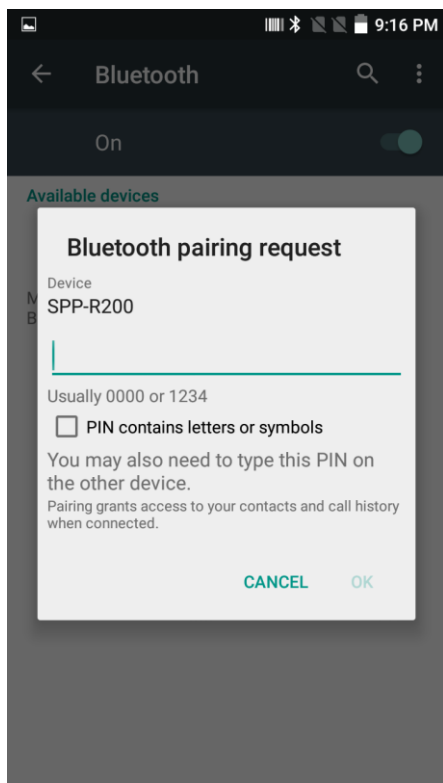

Guide on distance between the device and user

The device is tested in general conditions wherein the device is 0.5 cm apart from a user.



To meet the radiation safety and protection standards of the Ministry of Science, ICT and Future Planning, the device and the antenna should be 0.5 cm or more from a user regardless of the antenna use.

It is recommended to refrain from using a metal belt clip, case, or accessory.

Do not wear an accessory keeping 0.5 cm or shorter from the back part of the device or one that does not meet the radiation safety and protection standards of Ministry of Science, ICT and Future Planning.

3.5 NFC

3.5.1 Setting the NFC Feature

Activating the NFC Feature

- **Contactless** : It needs NFC battery cover and Enable NFC option in Wireless & networks settings.
- **Contact** : Before using the NFC feature, Insert a NFC USIM card into the device.

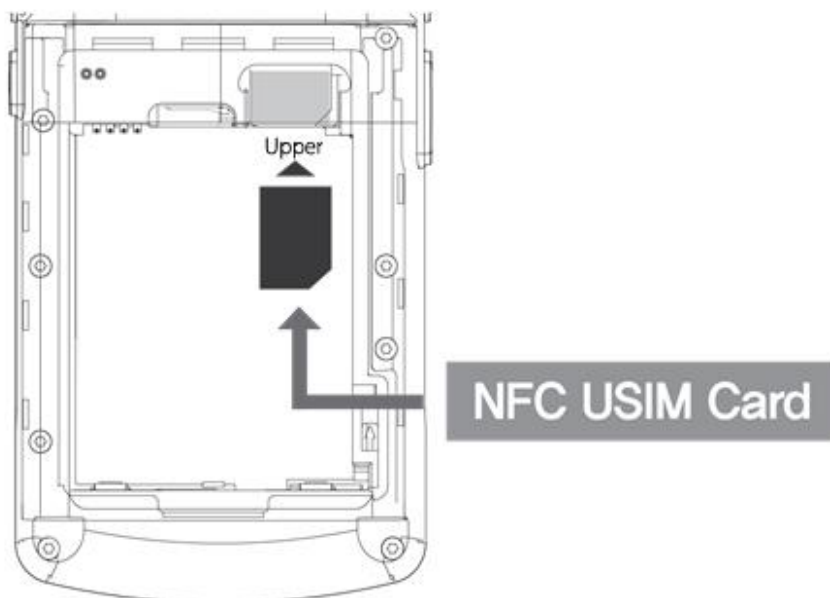



Insert the NFC USIM into USIM SLOT1 (front of Dual SIM Slot).



Swipe the bottom → Click **Settings** → **More...** → **NFC** to activate or deactivate NFC feature.

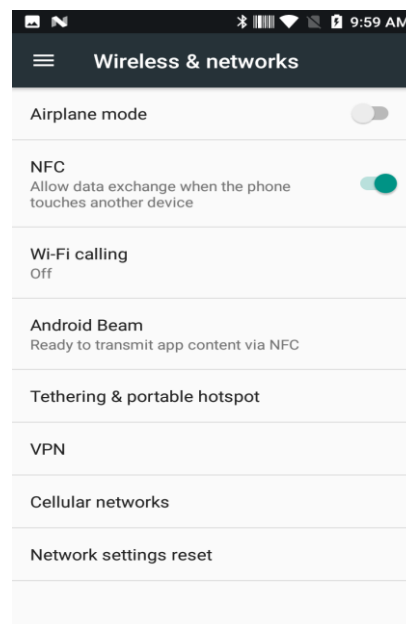
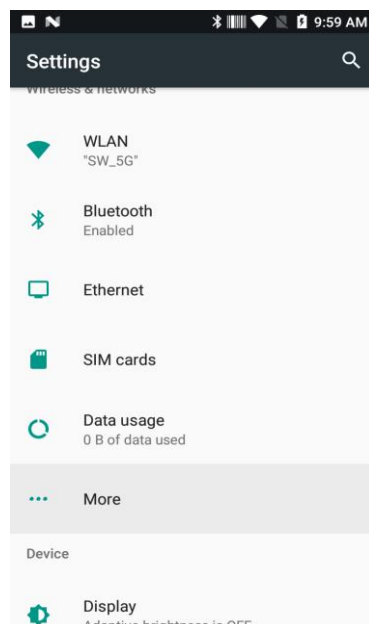
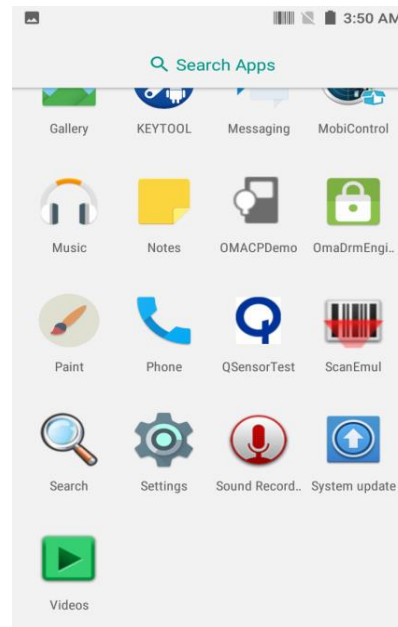
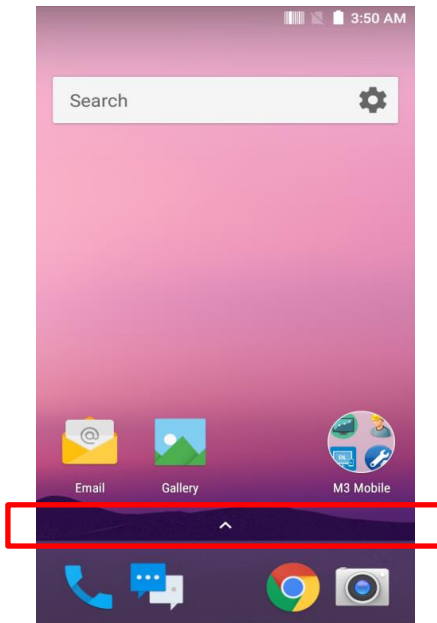

3.5.2 Connecting the NFC Feature

Connecting with the NFC Device

1. Open Web page or screen of a video, photo or contact.

2. Place back part of the NFC device toward back part of M3 SM15.
3. Touch the screen. Data transfer would then start.

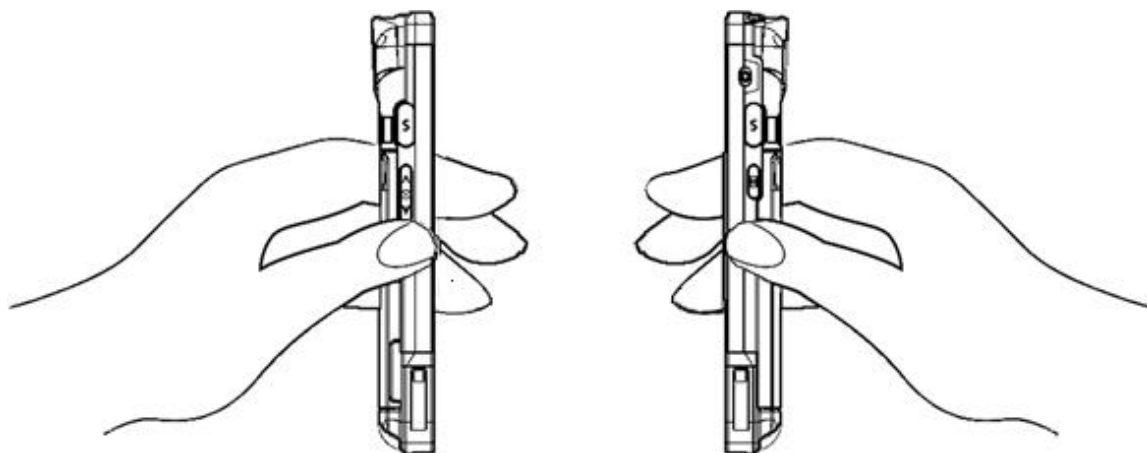

Caution when sharing data

While sharing data, the distance between devices should be less than 5 cm.



Caution when transferring data

When transferring data between devices, they do not need to be close. It is recommended to keep the distance between devices within 10 m.

Connecting to the NFC Chip / Tag Card

1. Hold M3 SM15 as shown below. Do not cover the antenna area of a battery cover with your hands.
2. Place M3 SM15 near NFC chip or tag card until data transfer is completed. (Generally, data is displayed in the application.)



Connecting to a Bluetooth Device with the NFC Feature

1. Hold M3 SM15 as shown below. Do not cover the antenna area of a battery cover with your hands.
2. Place M3 SM15 near the device. The device displays that connection is successfully performed.



4. Advanced Use

4.1 OS Update

The M3 Mobile distributes new OS to improve the quality and performance of a product.

To check OS version of the device, **Swipe the bottom** → **Click**  **Settings** → **About Phone** and select the OS version.

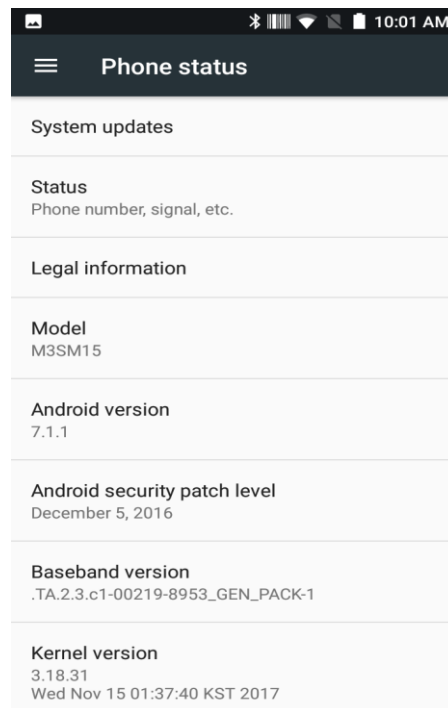
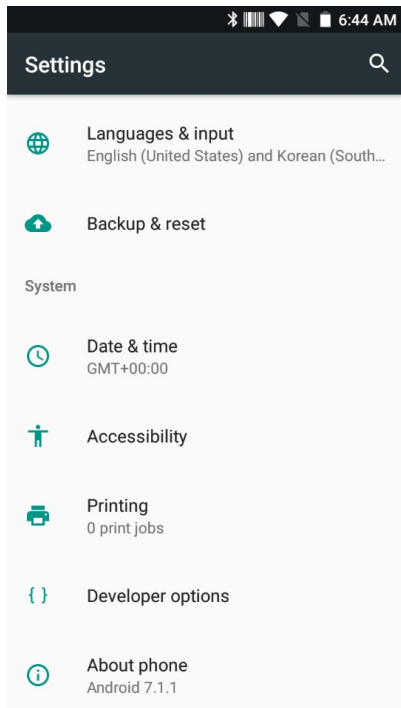
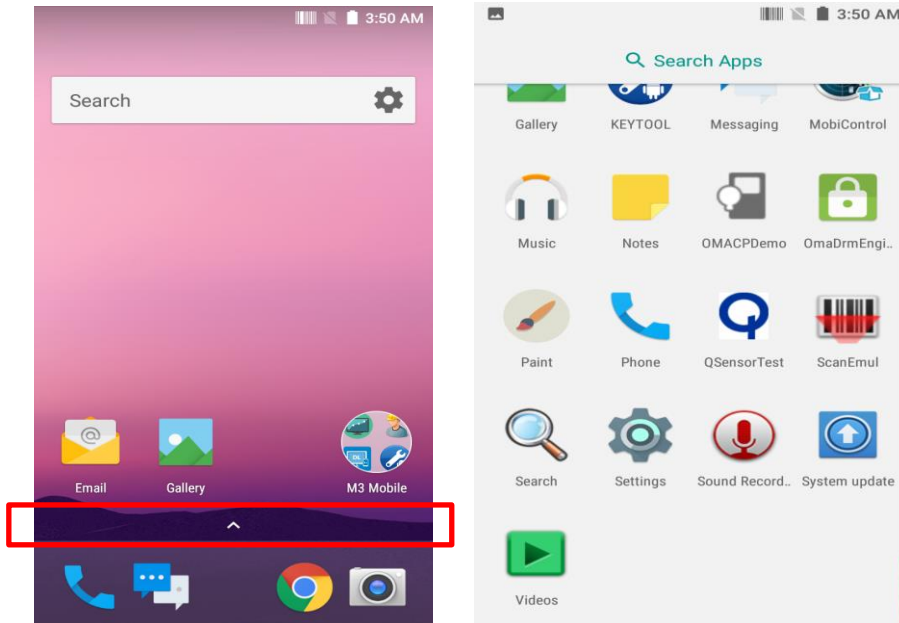

The above image is a sample.

The latest OS is described on the online support page of M3 Mobile.

The OS of M3 SM15 can be updated through two methods.

- i. Use Micro-SD card
- ii. Connect the device via Ethernet cradle or Snap-on

For detailed information on OS update, please refer to the "OS" item of the M3 FAQ (FAQ

[download](#)).

4.2 Key Setting Conversion

M3 SM15 allows a user to change and modify key settings for user convenience.

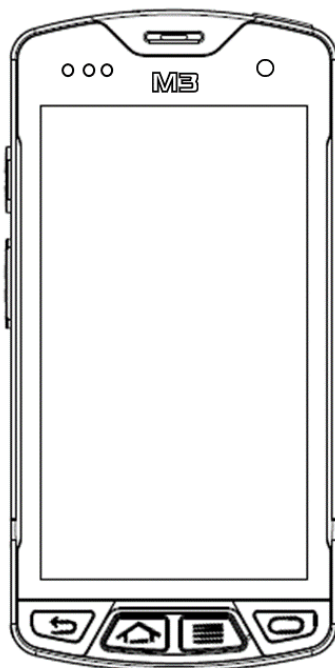

Keys can be set as follows:

SM15 KEYTOOL application

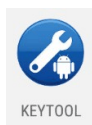

Swipe the bottom → Click **[KEYTOOL]**

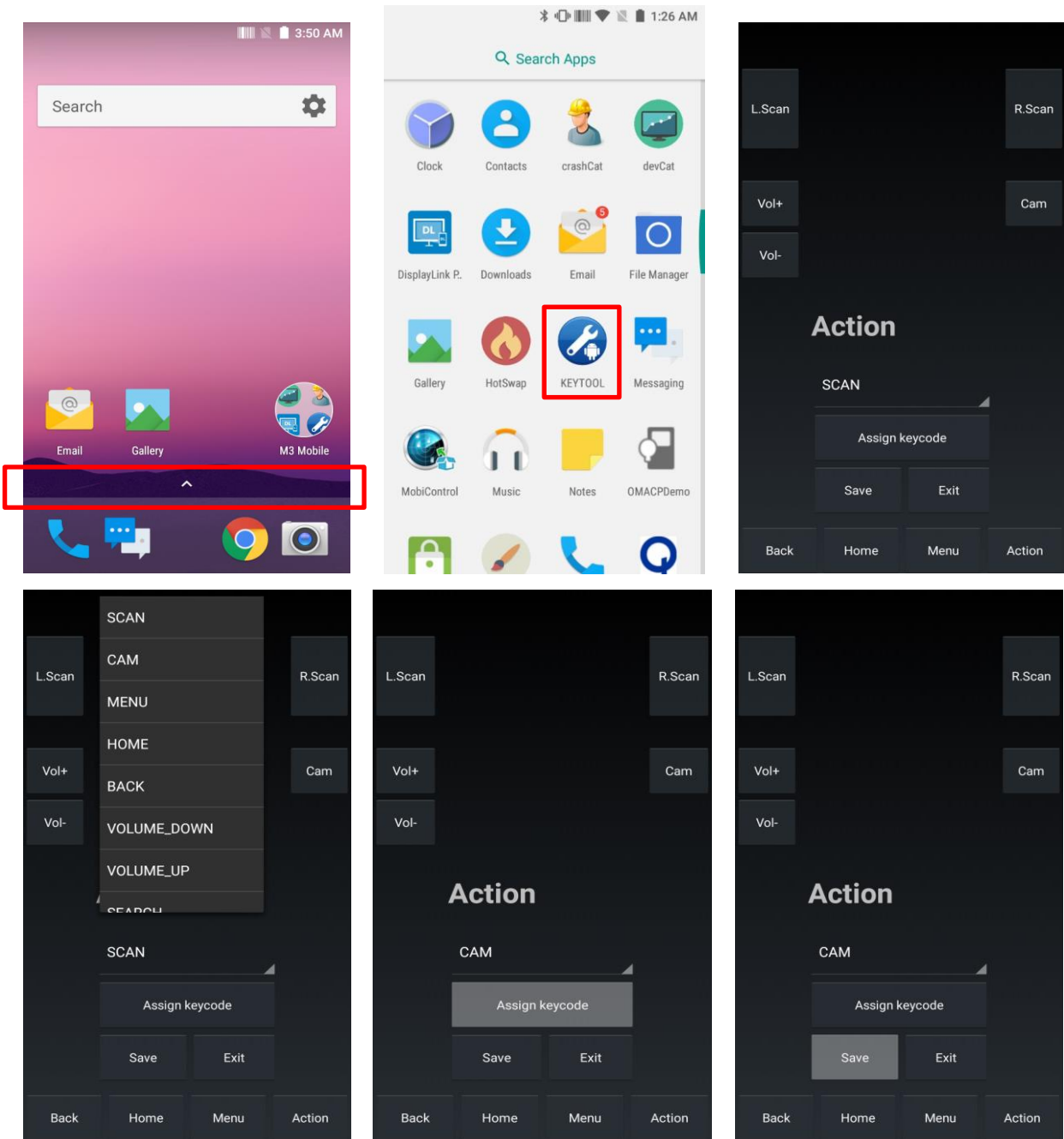

The setting of the device's physical buttons, except for Power button, can be changed.

4.3 Battery Hot swap

Sometimes people want to swap the battery without rebooting a device.

Because

- 1) Not saved application data is erased when device is rebooted.

2) Rebooting Time is too long.

Battery Hot swap function prevents this situation.

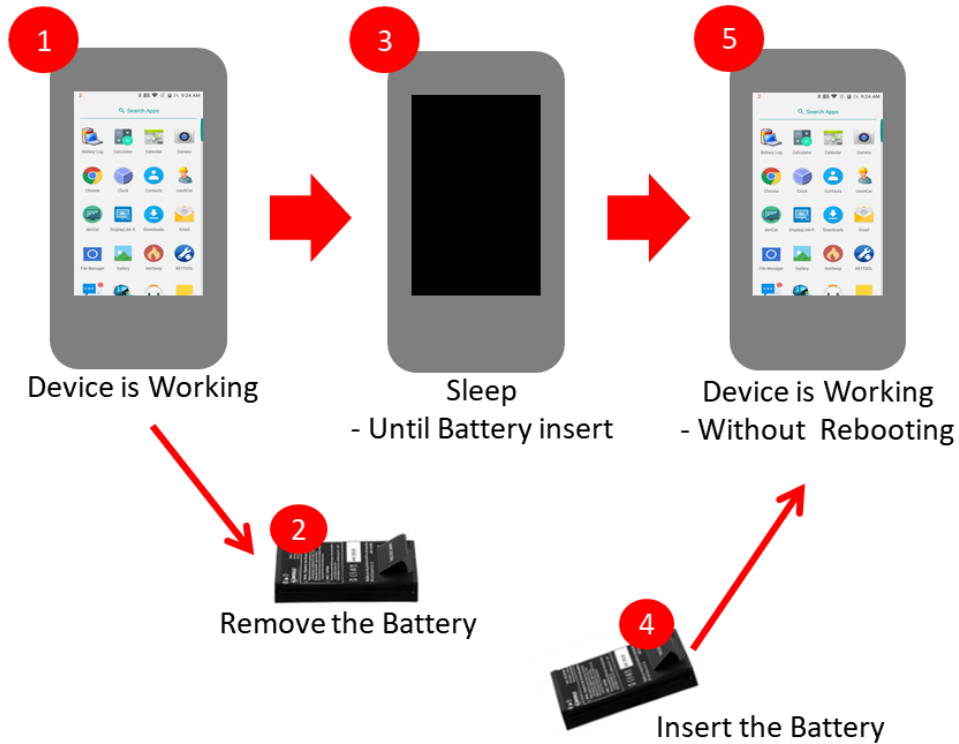



Procedure

Steps	1	2	3
Procedure	Run the APP	Notification PopUp	Execution
Images			

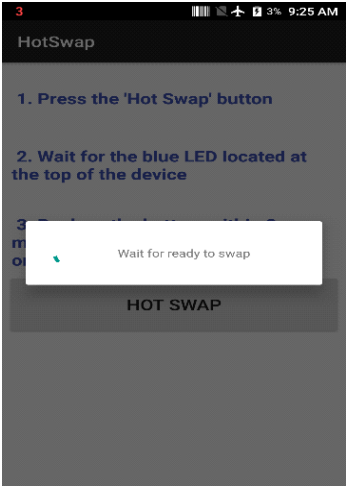
Estimated Time(Sec)	0 ~ 2	Wait Until ReRun the App	
Total Estimated Time(Sec)	0 ~ 2	2 ~ 4	2 ~ 4

Steps	3-1	3-2	3-3
Procedure	Check the Device's Status	Go to Airplane Mode	Go to Sleep Mode
Images			
Estimated Time(Sec)	3	1	0
Total Estimated Time(Sec)	5 ~ 7	6 ~ 8	6 ~ 8

Steps	4	5
Procedure	Wait Until Temporary Charging's done	Swap the battery within 2 minutes

Images		
	Notification LED Light	
Estimated Time(Sec)	5 ~ 8	120
Total Estimated Time(Sec)	11~16	

4.4 Fast Charging

The SM15 battery has added fast charging, which is performance to charge battery faster than the SM10 LTE battery charging function.

When you use fast charging function, you can keep it faster as much as about half an hour.

By using a PCM(Protection Circuit Module) in each cell, more current is used, which improves charging times and eliminates risk of battery explosion due to overcurrent. So, you can experience faster charging time than before.

Device		SM10 LTE * Standard Battery	SM15 * Standard Battery
Charging hour	Charging cradle	3hour 30min	2hour 50min
	Ethernet cradle	2hour 50min	2hour 20min





Caution when Charging

While charging, must use 5V/5A power adapter.

Must use SM15 series compatible accessories.

5. Others

5.1 SM15X Device Specifications

Physical Features	
Size (W x L x H) mm/inch	76.4 x 154.8 x 21.6 mm
	3.00 x 6.09 x 0.85 inch
Weight	280 g / 11.8 oz (Including battery)
Screen	5.0" FHD TFT LCD, 1920 x 1080 pixels
Battery	Li-ion, 3.8 V  4,100 mAh
	Li-ion, 3.8 V  6,150 mAh

Performance	
Processor	CPU 2.2 GHz Octa-core processor
OS	Android 7.1 (8.x is scheduled)
Memory	RAM 4 GB
	ROM 32 GB
	Card Slot Micro SD (Up to 128 GB)
Interface	Micro USB via Snap on



User Environment	
Temperature	Use Temperature -20 to 60 °C
	Storage Temperature -30 to 80 °C
Humidity	95% Non-condense
Tumble Test	1,000 1.6 ft./0.5M tumbles (2,000 drops - Bumper case mounted)
	500 1.6 ft./1M tumbles (1,000 drops - Bumper case not mounted)
Drop Test	1.8 M / 6.0 ft. (Bumper case mounted)
	1.2 M / 3.9 ft. (Bumper case not mounted)
IP rate	IP65

Wireless Communication Specification	
WWAN	GSM: 850/900/1800MHz Max E.I.R.Power : 32.3/29.2dBm
	WCDMA : 850/900/2100MHz Max E.I.R.Power : 22.14/22.24dBm
	LTE : FDD B1, B3, B5, B7, B8, B20 Max E.I.R.Power: 22.24/23.29/22.19/23.62/23.12dBm
Wireless LAN	IEEE 802.11 a/b/g/n/ac * Indoor use only in 5150-5350MHz band 2.4 GHz Max E.I.R.Power : 17.66dBm 5 GHz Max E.I.R.Power : 10.86dBm
Security	WEP, WPA, WPA2, TKIP, AES, EAP-FAST, EAP-TLS, EAP-TTLS, PEAP-GTC, PEAP- TLS, PEAP-MSCHAPv2, LEAP, CCXv4
Bluetooth	Bluetooth Class II 4.1 LE Max E.I.,R.Power :8.837dBm
NFC	ISO 1443 A/B, ISO 15693, Mifare, P2P Max Power: -13.75dBuA/m
GPS	A-GPS, GLONASS, Beidou

General Options	
Scanner	1D / 2D
Camera	Front: 5 M pixels auto-focus (AF) Rear: 16 M pixels auto-focus (AF)
Keypad	Four physical buttons on the lower section



5.2 SM15N Device Specifications

Physical Features	
Size (W x L x H) mm/inch	76.4 x 154.8 x 21.6 mm
	3.00 x 6.09 x 0.85 inch
Weight	280 g / 11.8 oz (Including battery)
Screen	5.0" HD TFT LCD
Battery	Li-ion, 3.8 V  4,100 mAh Li-ion, 3.8 V  6,150 mAh

Performance	
Processor	CPU 2.0 GHz Octa-core processor
OS	Android 7.1 (8.x is scheduled)
Memory	RAM 2 GB
	ROM 16 GB
	Card Slot Micro SD (Up to 128 GB)
Interface	Micro USB via Snap on



User Environment	
Temperature	Use Temperature -20 to 60 °C
	Storage Temperature -30 to 80 °C
Humidity	95% Non-condense
Tumble Test	1,000 1.6 ft./0.5M tumbles (2,000 drops - Bumper case mounted) 500 1.6 ft./1M tumbles (1,000 drops - Bumper case not mounted)
Drop Test	1.8 M / 6.0 ft. (Bumper case mounted)
	1.2 M / 3.9 ft. (Bumper case not mounted)

IP rate	IP65
Wireless Communication Specification	
WWAN	GSM: 850/900/1800MHz Max E.I.R.Power : 32.3/29.2dBm
	WCDMA : 850/900/2100MHz Max E.I.R.Power : 22.14/22.24dBm
	LTE : FDD B1, B3, B5, B7, B8, B20 Max E.I.R.Power: 22.24/23.29/22.19/23.62/23.12dBm
Wireless LAN	IEEE 802.11 a/b/g/n/ac * Indoor use only in 5150-5350MHz band 2.4 GHz Max E.I.R.Power : 17.66dBm 5 GHz Max E.I.R.Power : 10.86dBm
Security	WEP, WPA, WPA2, TKIP, AES, EAP-FAST, EAP-TLS, EAP-TTLS, PEAP-GTC, PEAP-TLS, PEAP-MSCHAPv2, LEAP, CCXv4
Bluetooth	Bluetooth Class II 4.1 LE Max E.I.,R.Power :8.837dBm
NFC	ISO 1443 A/B, ISO 15693, Mifare, P2P Max Power: -13.75dBuA/m
GPS	A-GPS, GLONASS, Beidou

General Options	
Scanner	1D / 2D
Camera	Rear: 13 M pixels auto-focus (AF)
Keypad	Four physical buttons on the lower section



5.3 SM15W Device Specifications

Physical Features	
Size (W x L x H) mm/inch	76.4 x 154.8 x 21.6 mm
	3.00 x 6.09 x 0.85 inch
Weight	280 g / 11.8 oz (Including battery)
Screen	5.0" HD TFT LCD
Battery	Li-ion, 3.8 V  4,100 mAh Li-ion, 3.8 V  6,150 mAh

Performance	
Processor	CPU 2.0 GHz Octa-core processor
OS	Android 7.1 (8.x is scheduled)
Memory	RAM 2 GB
	ROM 16 GB
	Card Slot Micro SD (Up to 128 GB)
Interface	Micro USB via Snap on

User Environment	
Temperature	Use Temperature -20 to 60°C
	Storage Temperature -30 to 80 °C
Humidity	95% Non-condense
Tumble Test	1,000 1.6 ft./0.5M tumbles (2,000 drops - Bumper case mounted) 500 1.6 ft./1M tumbles (1,000 drops - Bumper case not mounted)
Drop Test	1.8 M / 6.0 ft. (Bumper case mounted) 1.2 M / 3.9 ft. (Bumper case not mounted)
IP rate	IP65

Wireless Communication Specification	
WWAN	N/A
	N/A
	N/A
Wireless LAN	IEEE 802.11 a/b/g/n/ac ※ Indoor use only in 5150-5350MHz band 2.4 GHz Max E.I.R.Power : 17.66dBm 5 Ghz Max E.I.R.Power : 10.86dBm
Security	WEP, WPA, WPA2, TKIP, AES, EAP-FAST, EAP-TLS, EAP-TTLS, PEAP-GTC, PEAP- TLS, PEAP-MSCHAPv2, LEAP, CCXv4
Bluetooth	Bluetooth Class II 4.1 LE Max E.I.,R.Power :8.837dBm
NFC	N/A
GPS	N/A

General Options	
Scanner	1D / 2D
Camera	Rear: 13 M pixels auto-focus (AF)
Keypad	Four physical buttons on the lower section



5.4 Service

If you have any questions or complaints with using our product, please contact **M3 Service Center** or visit our **Web site** (<http://itc.m3mobile.net>). We do our best to immediately respond to your inquiry.

The M3 FAQ document may help resolve general problems.

For any questions on work programs, please contact the program supplier for faster service.

5.4.1 Contacts

Head Office

4F, Namjeon Bldg, 44, Gu-ui Gangbyeon-ro, Gwangjin-gu, Seoul, Korea, 05116

Tel: +82 2 574 0037 Fax: +82 2 558 1253

www.m3mobile.net, sales@m3mobile.co.kr , sales_eu@m3mobile.co.kr

Service Center

Chun-ui Techno Park 201-610, 202, Chunui-dong, Wonmi-gu, Bucheon, Gyeonggi-do, 420-857, Korea

Tel: +82 32 623 0037 Fax: +82 70 4015 6323

Web site

<http://itc.m3mobile.net>

E-mail

Information Technology Team : it@m3mobile.co.kr,

Customer Service Team : cs@m3mobile.co.kr

M3 MOBILE