

# sewoo

**Aroot Co., Ltd.**

28-6, Gajangsaneopdong-ro, Osan-si, Gyeonggi-do, 18103, Republic of Korea  
TEL +82-31-8077-5000 / FAX +82-31-624-5310 / <http://www.miniprinter.com>

**sewoo**



**MOBILE PRINTER**  
**MODEL : LK-P12 II**

---

USER'S MANUAL / Non Peeler

All specifications are subject to change without notice

**This device complies with part 15 of the FCC Rules.  
Operation is subject to the following two conditions.**

- 1) This device may not cause harmful interference, and
- 2) This device must accept any interference received, including interference that may cause undesired operation.

**Vic Barczyk**

19700 S Vermont Ave Ste 200 Torrance, CA 90502 | USA  
sales@miniprinter.com

**Henning Mahlstedt**

26188 Edeweicht, Holljestr.9 | Germany  
europe@miniprinter.com

**Victor Almazan**

Paseo de la Reforma No. 265 Piso 2.Oficina SBC. Col.  
Cuauhtémoc, C.P. 06500 Ciudad de Mexico | Mexico  
sales@miniprinter.com

**Yan xiao rui**

Room 902, No. 7, Lane 118, Xiaojishan Road, Sheshan Town,  
Songjiang District, Shanghai | China  
sales@miniprinter.com



**Risk of explosion if battery is replaced by an incorrectly type.  
Dispose of used battery according to the local disposal instructions.**



**Disposal of Old Electrical&Electronic Equipment(Applicable in the European Union and other European countries with separate collection systems)**

This symbol on the product or on its packaging indicates that this product shall not be treated as household waste. Instead it shall be handed over to the applicable collection point for the recycling of electrical and electronics equipment. For more detailed information about recycling of this product, please contact your local city office, your household waste disposal service or the shop where you purchased the product.

# Table of Contents

1. Safety Precautions	2
2. Unpacking	4
3. Product Overview	5
4. Setting Up the Product	6
4-1. Display	6
4-2. Installing the Battery	7
4-3. Removing the Battery	8
4-4. Charging the Battery	9
4-5. Car charger Usage	10
4-6. Belt clip Usage	11
4-7. Paper Roll Installation	12
4-8. Shoulder Strap Installation	13
4-9. Diagnostic Test	14

<b>5. Peripheral Connection</b>	<b>16</b>
5-1. Bluetooth Connection	16
5-2. Wi-Fi Connection	16
5-3. Interface Cable Connection	17
<b>6. Cleaning the Printer</b>	<b>18</b>
6-1. Print-Head Cleaning	18
6-2. Platen Roller Cleaning	19
<b>7. Roll Media Specification</b>	<b>20</b>
<b>8. Label specification</b>	<b>21</b>
<b>9. Printer Specification</b>	<b>22</b>
<b>10. CPCL Command Compatibility</b>	<b>24</b>
<b>11. ESC/POS Command Compatibility</b>	<b>27</b>
<b>12. ZPL Command Compatibility</b>	<b>29</b>
<b>13. Utilities</b>	<b>33</b>
<b>14. S/W</b>	<b>34</b>

# 1. Safety Precautions

For better safety and reliability, adhere to the following precautionary measures. Read and follow the instructions carefully before operation of the product.

## Indication



Prohibition



Must follow



Do not disassemble



Unplug the power from the outlet



Grounding to prevent electric shock



Do not handle the product with wet hands



## WARNING

Failure to follow these instructions could result in fire, electric shock, other injuries, or property damage.



**Do not pull or touch the power plug with wet hands.**

Potential risk of electric shock or fire



**Do not bend the wire and do not allow the wire to be pinched or crushed by heavy objects.**

Potential risk of electric shock or fire

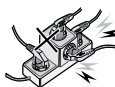

**Do not overload an electrical outlet.**

Potential risk of electric shock or fire



**If a power plug is broken or a plug is cut or worn, do not use it.**

Potential risk of electric shock or fire





## WARNING

Failure to follow these instructions could result in fire, electric shock, other injuries, or property damage.



Do not unplug the power cable to turn off the product.

Turn off the power using the power button



Do not disassemble, repair or modify the product.

Potential risk of malfunction, electric shock, or fire. When the product needs to be repaired, please contact your reseller



## CAUTION

Failure to follow these instructions could result in fire, electric shock, other injuries, or property damage.



Do not install the product on an unstable or inclined surface.

May cause damage or injury



If the product needs to be repaired, please contact your reseller.

Potential risk of fire or unit malfunction



Keep product away from the water and other material.

Potential risk of fire or unit malfunction



Avoid excessive shock or drops.

Potential risk of fire or property damage





## 2. Unpacking

### Standard

---



Printer

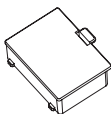

Battery

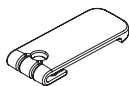

Belt Clip

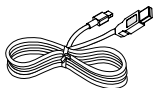

USB Cable

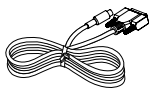

Serial Cable

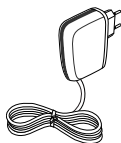

Recharger

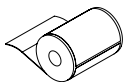

Paper



CD



Quick Reference

### Optional

---

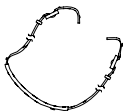

Shoulder Strap



Car Adapter



Battery Holder(Cradle)

### 3. Product overview

#### Front

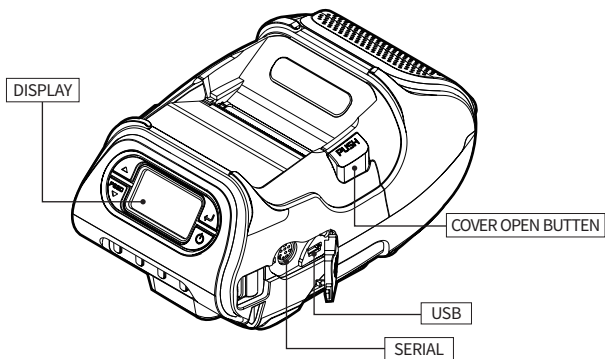



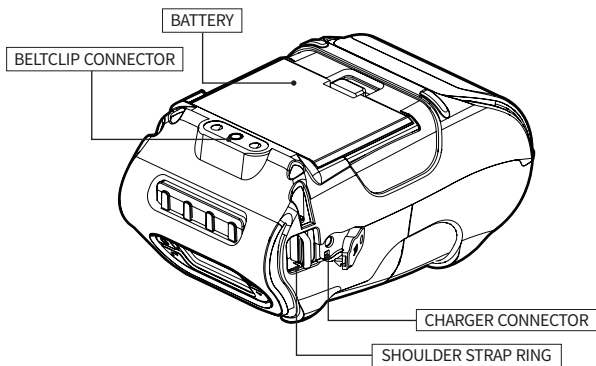

#### Bottom

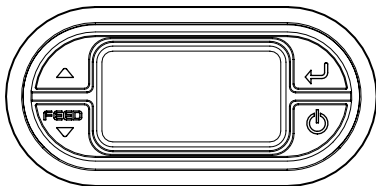

## 4. Setting Up the Product

### 4-1. Display



Button	Name	function
	Paper Feed/ Down Button	- Advances the paper, clears error messages, and moves down through menu options. 01 Refer to "4-9" for Diagnostic Test information. 02 Refer to the service manual regarding Hexadecimal Dumping.
	Enter Button	- Selects the highlighted menu option.
	Up Button	- Moves up through menu options.
	Power Button	- Turns the printer on and off. Press to turn Power on. Press for three seconds to turn power off. - Wakes the printer from sleep mode.

#### ✓ NOTE

- 01 The battery status icon in LCD indicates amount of power remaining. Actual run-time remaining depends on factors such as the contents of output, distance to computer, etc.
- 02 When the battery level is very low, high density printing can result in the printer switching off during printing resulting in possible loss of data.

## 4-2. Installing the Battery

---

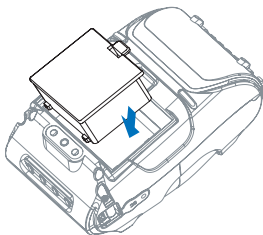

Insert the battery as shown.

---

1  
2

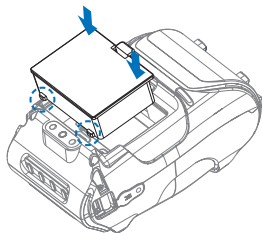

Replace the battery.

**✓ NOTE**

You must fully charge the battery when you receive the printer.  
Batteries can be charged in the printer or in an optional external cradle.

### 4-3. Removing the Battery

---

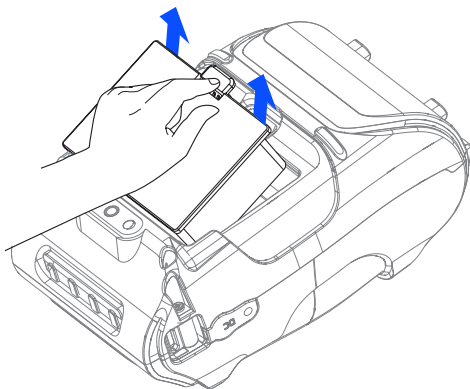

Remove the battery as shown.

## 4-4. Charging the Battery

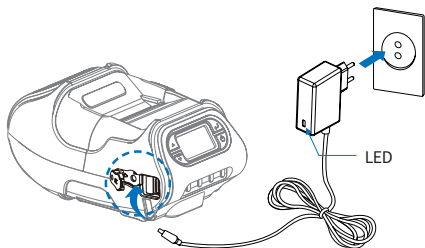

- 1 Be sure the printer is turned off.
- 2 After opening the DC JACK cover, insert DC JACK into the printer.
- 3 Plug the power cord into the electrical outlet.

### The charge indicator LED

Status	charging	charging complete
Charging Lamp	Red	Green

#### ✓ NOTE

- 01 If the charger provided by the manufacturer is not used, the printer can be damaged, and the manufacturer is not liable for the consequential damage.
- 02 Before removing the battery, make sure that power is turned off.
- 03 The printer does not work when only connected to the charger.
- 04 The battery needs to be installed to operate the printer.
- 05 While charging, do not turn on the power.
- 06 Do not operate the printer while charging the battery.
- 07 Do not connect the charger while the printer is operating.

## 4-5 Car charger Usage *Optional*

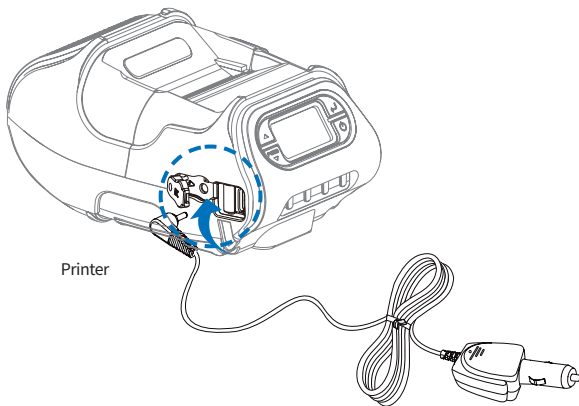

Printer

Connect the car charger to the printer.

<b>Input</b>	12 ~ 24V
<b>Output</b>	8.4 V, 1.0 A

**✓ NOTE**

Connect the car charger to the printer.

## 4-6. Belt clip Usage

---

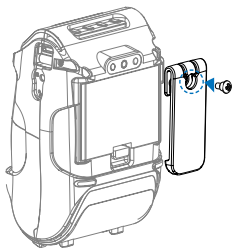

Insert screw into belt clip.

---

1  
2

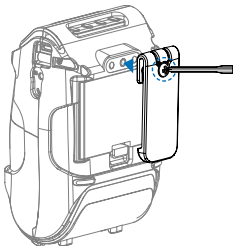

Tighten the screw with driver as shown.

**✓ NOTE**

The belt clip is included with the printer but is not required to be used or installed!



## 4-7. Roll Paper Installation

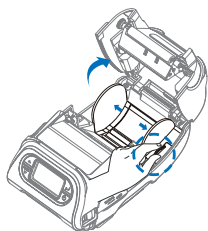

Open the Paper cover by pressing the Open button. You can set the width of paper guide by turning the knob with your finger.

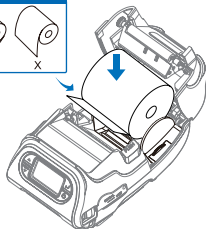
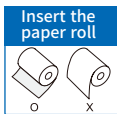

Insert the paper roll so it unrolls from the bottom. Remove the paper core when the roll is empty. Pull a short length of paper out of the printer.

1 2  
3 4

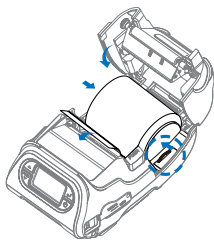

Close the cover.

### NOTE

If the users close the cover with one hand, it would not be closed completely. Please use both hands to close.

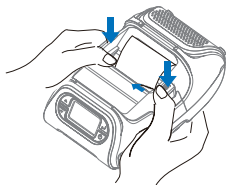

Close the Paper cover with both hands and feed some paper by pressing the Feed button.

## 4-8. Shoulder Strap Installation *Optional*

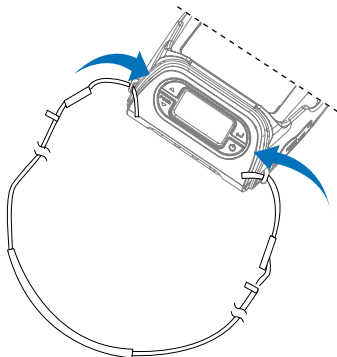

Insert the strap into the hook of the printer.

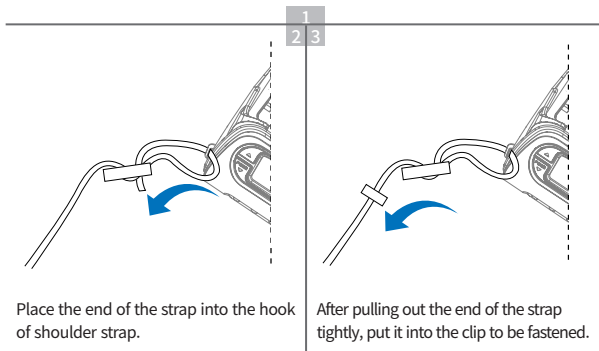

Place the end of the strap into the hook of shoulder strap.

After pulling out the end of the strap tightly, put it into the clip to be fastened.

## 4-9. Diagnostic Test

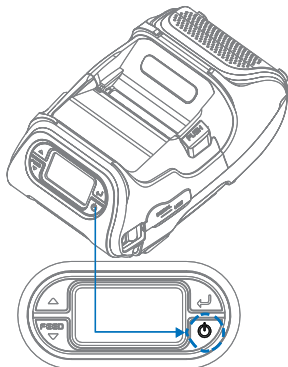

Turn off the printer.

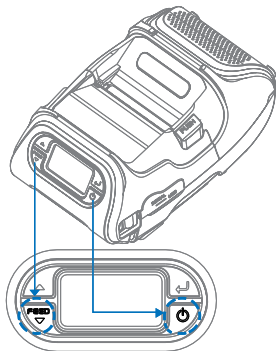

Press and hold the feed button and power button.



The self-test will print.

1 2  
3

### ✓ NOTE

- 01 For Hex Dump mode, do steps 1-2 then press the feed button.
- 02 After printing ASCII pattern, the diagnostic test is complete.
- 03 If the feed button is not pressed to go to Hex Dump mode, the printer exits diagnostics after three seconds.

## Self-Test Printout Sample

### SEWOO, LK-P12II

#### Printer Configuration Info.

F/W Version: v2.00  
Font/Rom Version: 1.0  
GAP(Adj): 80(-8,210)  
BM Lower(Adj): 125(196)  
BM Upper(Adj): 144(256)  
Pie: ADC : 255, DAC : 512  
Battery: 7.7v [28 C]  
Timeout(Sleep): 60 sec  
Ext. Flash : None  
H/W Version: v5.4  
Peel Module : Not Install  
Error Clear : Press Feed Key

#### Emulation Configuration Info.

Emulation: ESC/POS  
Print Density: Normal(0)  
codepage 437  
Print Power : Normal Energy  
Top Of Form: 0  
Top Margin: 0  
Left Margin: 0

#### Serial Interface

Baud : 9200  
Data bit : 8bit  
Parity Bit : none  
Stop bit : 1bit

#### USB Interface

Version 2.0 Full speed  
compliant  
Product String: LK-P12II

#### Bluetooth Interface

Version: v0154  
Device Name: Mobile Printer  
Mode: SPP, ONLY  
Auto connection: Disabled  
BLE: Disabled  
Address: 00:07:80:c4:2e:90



000780c42e90

\*\*\*\*\*  
! " # \$ % & ' ( ) \* + , - . / 0 1 2 3 4 5 6 7 8 9 ; < > ?  
@ A B C D E F G H I J K L M N O P Q R S T U V W X Y Z [ \ ] \_  
` a b c d e f g h i j k l m n o p q r s t u v w x y z { | } ~  
\*\*\*\*\*  
C u e b a a b c d e f g h i j k l m n o p q r s t u v w x y z  
a i O u P R s t - 1 2 3 4 5 6 7 8 9 1 0 1 1 1 2 1 3 1 4 1 5 1 6 1 7 1 8 1 9 2 0  
1 2 3 4 5 6 7 8 9 1 0 1 1 1 2 1 3 1 4 1 5 1 6 1 7 1 8 1 9 2 0  
a b c d e f g h i j k l m n o p q r s t u v w x y z 1 2 3 4 5 6 7 8 9 1 0  
\*\*\*\*\*  
\*\*\*\*\*  
Press FEED button to  
enter HEX-DUMP mode.  
\*\*\*\*\*

Upon initial installation or for troubleshooting, you can run the diagnostic test to get information about:

- Firmware version, emulation, codepage, sensor settings, interface settings, etc.

If no issues are found with the diagnostic test, examine other devices and software.

The diagnostic test is working independently of devices and software.

### ※ Motor protection from being overheated

To prevent the motor from overheating, stop the printer for at least 30 seconds after continuously printing 1.5 meters.

## 5. Peripheral Connection

This product can communicate with other devices via Bluetooth, Wi-Fi, or a communication cable.

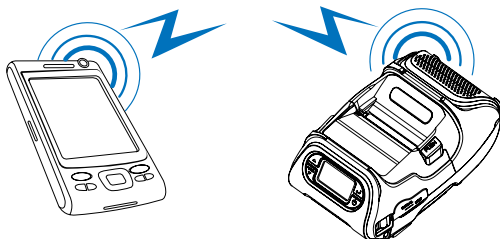

### 5-1. Bluetooth Connection *Optional*

---

- 1 The Printer can be connected to devices equipped with Bluetooth communication capabilities(PDAs, PCs, etc.).
- 2 Use the Bluetooth connection function supported by your device to connect to the printer.

**✓** NOTE

- This model supports numeric comparison function.
- Please refer to the configuration manual for details.

### 5-2. Wi-Fi Connection *Optional*

---

- 1 The Printer can be connected to devices equipped with Wi-Fi communication capabilities(PDAs, PCs, etc.).
- 2 Use the Wi-Fi connection function supported by the device to connect to the printer.

**✓** NOTE

- Please refer to the configuration manual for details.

## 5-3. Interface Cable Connection

---

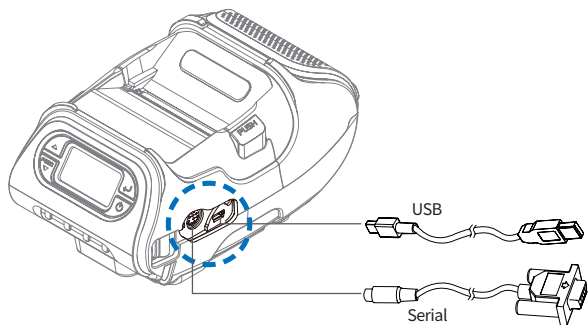

- 1 Connect USB or Serial cable to the connector on the printer.

**✓ NOTE**

– Only use cables included with the printer.

- 2 Connect the interface cable to the USB port of the device(PDA, PC, etc.).

## 6. Cleaning the Printer

If the interior of the printer is dusty, printing quality can be reduced.

In this case, follow the instructions below to clean the printer.

### ✔ NOTE

- 01 Make sure to turn the printer power off prior to cleaning.
- 02 Regarding printhead cleaning, as the printhead gets very hot during printing, turn off the printer power and wait approximately 10 minutes before cleaning.
- 03 When cleaning the printhead, take care not to touch the heated portion of the printhead. The printhead can be damaged by static electricity.
- 04 Take care not to allow the printhead to become scratched and / or damaged in any way.

### 6-1. Print-Head Cleaning

---

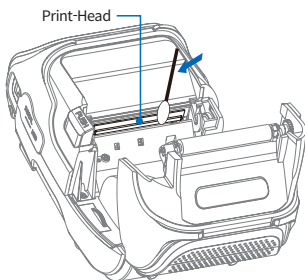

- 1 Use an applicator swab moistened with an alcohol solution to clean the printhead and remove any dust.
- 2 Once the cleaning is completed, wait a few minutes before inserting the paper roll into the printer.

## 6-2. Platen Roller Cleaning

---

- 1 Clean the platen roller with a clean soft cloth moistened with isopropyl alcohol or a cleaning pen.
- 2 Turn the platen roller with your finger to clean the entire surface.

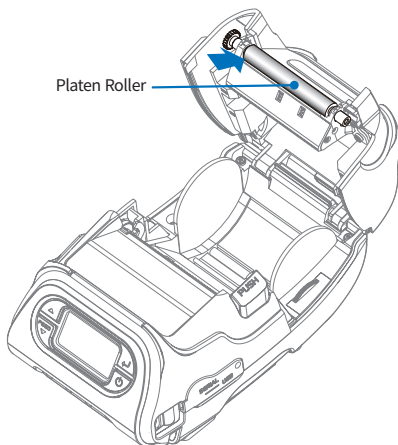



## 7. Roll Media Specification

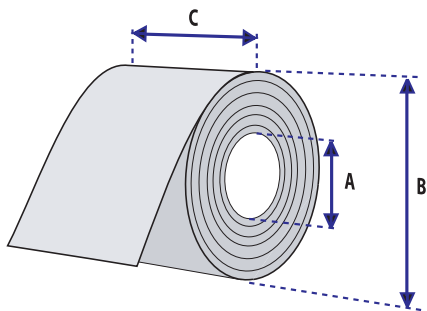

Core	
Diameter (A)	12.5mm $\pm$ 0.5mm
Roll	
Max.Diameter (B)	56 mm
Max.Media Width (C)	58 mm $\pm$ 0.5 mm
Min.Media Width (C)	12.7 mm $\pm$ 0.5 mm
Max.Media Thickness	0.16 mm
Min.Media Thickness	0.06 mm



Protect the printhead from sand, grit, and other hard particles during printing and storage. Keep the cover closed.

Even very small foreign particles may cause severe harm to the printhead.

## 8. Label Specification

<- a -> Media width(inch, liner)	
Maximum	54 mm $\pm$ 0.5 mm
Minimum	8.7 mm $\pm$ 0.5 mm
<- b -> Label length	
Minimum	12.7 mm ~ 300 mm
<- c -> Label gap height	
Maximum	8.3 mm
Minimum	1.8 mm
Liner	
Opacity	50 % ~ 75 %

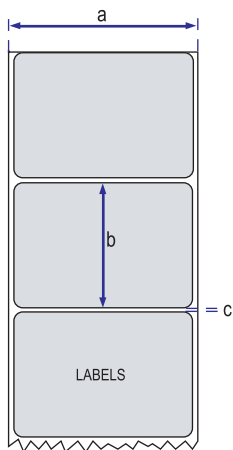

## 9. Printer Specification

Printing Method		Direct Thermal
Printing Speed		Max. 127 mm/s
Width		48 mm, 384 Dots/line
Resolution		203 DPI
Dot Pitch		8 Dot/mm, 0.125 Pitch
Character Per line (ESC/POS)	Font A(12x24)	32 columns
	Font B(9x17)	42 columns
Character	ESC/POS	FontA(12x24), FontB(9x17), Asian Font(KOR, JPN, CHN_GB2312, CHN_BIG5)
	CPCL	Font0/1/2/4/5/6/7, 24x24 Asian Font(KOR, JPN, CHN_GB2312, CHN_BIG5), Resident TTF, Downloadable TTF
	ZPL	FontA~H, FontGS, Resident TTF(Font0), Downloadable TTF
	EPL	Font1 ~ 8
Barcode	ESC/POS	- 1D : EAN-8, EAN-13, Code39, ITF, UPC-A, UPC-E, Codabar, Code93, Code128 - 2D : QR, PDF417
	CPCL	- 1D : LUPC-A(+2,+5), UPC-E(+2, +5), EAN13(+2,+5), EAN8(+2,+5), Code39 etc. (CPCL) - 2D : QR, PDF417, MicroPDF417, Maxicode, Datamatrix, Aztec, TLC39, RSS14
	ZPL	- 1D : Code11, ITF, Code39, Planet, EAN-8, UPC-E, Code93, Code128 etc. (ZPLII) - 2D : QR, PDF417, MicroPDF417, Maxicode, Datamatrix, Aztec, TLC39, RSS14
	EPL	- 1D : Code39, Code93, Code128, Codabar, EAN-(+2,+5), EAN13(+2,+5), ITF etc. (EPLII) - 2D : QR, PDF417, Maxicode, Datamatrix, Aztec, RSS14
Emulation		ESC/POS, CPCL, ZPL Command compatible

Driver	Windows Driver(10, 2012, 8, 7, 2008, VISTA, 2003, XP, 32bit & 64bit), Window CE & Mobile Driver & SDK(CE 4.2~, Mobile 5.0~), Linux Driver, Mac Driver, OPOS Driver, Java POS Driver, iOS SDK, Android(2.1~) SDK, Blackberry SDK, Symbian	
Sensor	Paper end, Gap, Black mark, Cover open	
Drop Resistance	1.5M onto concrete	
LCD	FSTN LCD 128 x 64 dots	
Paper	Paper type	Thermal paper / Label
	Width	12.7 mm ~ 58 mm
	Thickness	0.06 mm ~ 0.16 mm
	Roll Max Diameter	56 mm
	Roll Core	12.5 mm ± 0.5 mm
Reliability	TPH	50 km
Communications	Standard	Serial(RS-232C), USB
	Optional	Bluetooth Smart ready 4.2 or Wi-Fi(802.11a/b/g/n)
Battery Charger	Input	AC100 ~ 240V, 50 / 60Hz
	Output	8.4 V, 1.0 A
Battery	Battery type	Li-ion
	Output	7.4V, 2600mAh / 19.24Wh
	Charging time	3.3 Hrs / 85 Hrs Stand-by
Size	WxDxH(mm)	104 x 158 x 85
	WxDxH"	4.1 x 6.22 x 3.34
Weight	570g	
Environmental sealing	IP42	
Temperature	Operation	-10 ~ 50°C
	Storage	-20 ~ 60°C
Humidity	Operation	10 ~ 90%
	Storage	10 ~ 90%

# 10. CPCL Command Compatibility

**NOTE**

Compatible	Compatible with only commanders provided by the manufacturer.	Partially Compatible	Not Compatible
○	●	△	X

Printer Commands	Compatibility
PRINT	○
FORM	○
JOURNAL	○
UNITS	○
USING COMMENTS	○
TEXT	Compatibility
TEXT	○
FONT-GROUP(FG)	○
TEXT CONCATENATION	○
MULTILINE(ML)	○
COUNT	○
SETMAG	○
SCALABLE TEXT	Compatibility
SCALE-TEXT	○
SCALABLE CONCATENATION	○
LINEAR BARCODES	Compatibility
BARCODE	○
BARCODE-TEXT	○
COUNT	○
Two-Dimensional BarCodes	Compatibility
PDF417(PORTABLE DATA FILE)	○
MICROPDF-417	●
MAXICODE	○
QRCODE	○
DATAMATRIX	●
GS1(RSS-14)	○
AZTEC	○

<b>GRAPHICS</b>	<b>Compatibility</b>
BOX	<input type="radio"/>
LINE	<input type="radio"/>
INVERSE-LINE	<input type="radio"/>
PATTERN	<input type="radio"/>
GRAPHICS	<input type="radio"/>
PCX	<input type="radio"/>
<b>Advanced Commands</b>	<b>Compatibility</b>
CONTRAST	<input type="radio"/>
TONE	<input type="radio"/>
JUSTIFICATION	<input type="radio"/>
PAGE-WIDTH	<input type="radio"/>
PACE	<input type="radio"/>
NO-PACE	<input type="radio"/>
WAIT	<input type="radio"/>
SPEED	<input type="radio"/>
SETSP	<input type="radio"/>
ON-FEED	<input type="radio"/>
PREFEED	<input type="radio"/>
POSTFEED	<input type="radio"/>
COUNTRY / CODE PAGE	<input type="radio"/>
FORMAT FILES	<input type="radio"/>
BEEP	<input type="radio"/>
<b>Line Print Mode</b>	<b>Compatibility</b>
SETLP	<input type="radio"/>
SETLF	<input type="radio"/>
Moving With X and Y Coordinates	<input type="radio"/>
LMARGIN	<input type="radio"/>
SETBOLD	<input type="radio"/>
SETSP	<input type="radio"/>
Special ASCII Characters	<input type="radio"/>
SETFF	<input type="radio"/>
SET-TOF	<input type="radio"/>
SETLP-TIMEOUT	<input type="radio"/>

<b>ADVANCED UTILITIES</b>	<b>Compatibility</b>
VERSION	○
CHECKSUM	○
DEL	○
DIR	○
DEFINE-FILE	○
TYPE	○
BAUD	○
COUNTRY / CODE-PAGE	○
TIMEOUT	○
BEED	○
ON-LOW-BATTERY	○
LT	○
SET-TIME	○
GET-TIME	○
SET-DATE	○
GET-DATE	○
PRINTING A TIME STAMP	○
PRINTING A DATE STAMP	○
PAPER-JAM	○
<b>PRINTER ESCAPE</b>	<b>Compatibility</b>
SET AND READ CODE	△
STATUS / INFORMATION	○
USER LABEL COUNT	○
POWER OFF	○

## 11. ESC/POS Command Compatibility

Command	Function	Compatibility
HT	Horizontal tab	○
LF	Print and line feed	○
CR	Print and carriage return	○
FF	Print end position label to start printing	○
CAN	Cancel print data in page mode	○
DLE EOT	Real-time status transmission	○
DLE ENQ	Real-time request to printer	○
ESC FF	Print data in page mode	○
ESC SP	Set character right-side spacing	○
ESC !	Set print mode	○
ESC \$	Set absolute print position	○
ESC %	Select / cancel user-defined character set	○
ESC &	Define user-defined characters	○
ESC *	Set bit image mode	○
ESC -	Turn underline mode on/off	○
ESC 2	Set 1/6 inch line spacing	○
ESC 3	Set line spacing using minimum units	○
ESC ?	Cancel user-defined characters	○
ESC @	Initialize printer	○
ESC D	Set horizontal tab positions	○
ESC E	Select emphasized mode	○
ESC G	Select double-strike mode	○
ESC J	Print end feed paper using minimum units	○
ESC L	Select page mode	○
ESC M	Select character font	○
ESC R	Select international character set	○
ESC S	Select standard mode	○
ESC T	Select print direction in page mode	○
ESC V	Set / cancel 90 cw rotated character	○
ESC W	Set printing area in page mode	○



Command	Function	Compatibility
ESC \	Set relative position	○
ESC a	Align position	○
ESC d	Print and feed paper n lines	○
ESC t	Select character code table	○
ESC {	Set / cancel upside-down character printing	○
FS p	Print NV bit image	○
FS q	Define NV bit image	○
GS !	Select character size	○
GS \$	Set absolute vertical print position in page mode	○
GS *	Define downloaded bit image	○
GS /	Print down-loaded bit image	○
GS B	Turn white / black reverse printing mode on / off	○
GS H	Select printing position of HRI characters	○
GS I	Transmit printer ID	○
GS L	Set left margin	○
GS W	Set printing area width	○
GS \	Set relative vertical print position in page mode	○
GS a	Enable / disable Automatic Status Back(ASB)	○
GS f	Select font for HRI characters	○
GS h	Set bar code height	○
GS k	Print bar code	○
GS r	Transmit status	○
GS v 0	Print raster bit image	○
GS w	Set bar code width	○
GS S C	Set Serial Baudrate	○
DLE EOT n	Selects card read mode / Cancel card read mode	○
GS S P	Power Save Mode	○

## 12. ZPL Command Compatibility

Command	Compatibility
^A	<input type="radio"/>
^B0	<input type="radio"/>
^B1	<input type="radio"/>
^B2	<input type="radio"/>
^B3	<input type="radio"/>
^B4	<input type="radio"/>
^B5	<input type="radio"/>
^B6	<input type="radio"/>
^B7	<input type="radio"/>
^B8	<input type="radio"/>
^B9	<input type="radio"/>
^BA	<input type="radio"/>
^BB	<input type="radio"/>
^BC	<input type="radio"/>
^BD	<input type="radio"/>
^BE	<input type="radio"/>
^BF	<input type="radio"/>
^BI	<input type="radio"/>
^BJ	<input type="radio"/>
^BK	<input type="radio"/>
^BL	<input type="radio"/>
^BM	<input type="radio"/>
^BO	<input type="radio"/>
^BP	<input type="radio"/>
^BQ	<input type="radio"/>
^BR	<input type="radio"/>
^BS	<input type="radio"/>

Command	Compatibility
^BT	○
^BU	○
^BX	○
^BY	○
^BZ	○
^CC ~ CC	○
^CD	○
^CF	○
^CI	○
^CT ~ CT	○
~DF	○
~DG	○
^FB	○
^FC	○
^FD	○
^FH	○
^FN	○
^FO	○
^FP	○
^FR	○
^FS	○
^FT	○
^FV	○
^FW	○
^FX	○
^GB	○
^GC	○

Command	Compatibility
^GD	<input type="radio"/>
^GE	<input type="radio"/>
^GF	<input type="radio"/>
^GS	<input type="radio"/>
^ID	<input type="radio"/>
^IL	<input type="radio"/>
^IM	<input type="radio"/>
^IS	<input type="radio"/>
~JR	<input type="radio"/>
^JS	<input type="radio"/>
~JS	<input type="radio"/>
^KL	<input type="radio"/>
^LH	<input type="radio"/>
^LL	<input type="radio"/>
^LR	<input type="radio"/>
^LS	<input type="radio"/>
^LT	<input type="radio"/>
^MC	<input type="radio"/>
^MD	<input type="radio"/>
^MN	<input type="radio"/>
^PM	<input type="radio"/>
^PO	<input type="radio"/>
^PQ	<input type="radio"/>
^PR	<input type="radio"/>
~PR	<input type="radio"/>
^PW	<input type="radio"/>
^SC	<input type="radio"/>
^SD	<input type="radio"/>
^SF	<input type="radio"/>
^SL	<input type="radio"/>
^SN	<input type="radio"/>

Command	Compatibility
^SO	<input type="radio"/>
^ST	<input type="radio"/>
~TA	<input type="radio"/>
^XA	<input type="radio"/>
^XF	<input type="radio"/>
^XG	<input type="radio"/>
^XZ	<input type="radio"/>
^ZZ	<input type="radio"/>

## 13. Utilities

The following utilities and concerned manual can be found on the CD or homepage.

No.	Name	Description
1	Configuration Tool	This is a utility that allows you to set printers by interface. Detailed settings such as Wi-Fi, Ethernet, and COM ports can be configured.
2	Download Tool(F/W)	Printer F/W and Font Download are available, and BT, Wi-Fi module F/W Download is supported. – P22, 20II can download ICR F/W. – BT/Wi-Fi Download function is not supported for P400, P21, P25. – P400 supports SD Card Download function instead of Font Download.
3	NVUpload (ESC/POS)	With NVUpload running on Windows OS, you can upload and remove the bmp file as Logo in the printer's flash memory, and print test is possible.
4	Bitmap Font Download(CPCL)	It is a utility that allows you to change Windows Fonts stored on your PC into Bitmap Fonts for use on the printer.
5	LabelMaker(CPCL)	This program is for label form design and designed label printing.
6	Android Utility (Sewoo M_Utility) (ESC/POS)	It is a utility app that prints text, barcodes, images, etc. through Bluetooth and Wi-Fi communication, and able to printer settings.

## 14. S/W

We provides SDK, Driver, etc. as follows to respond to various S/W usage environments.

You can download this S/W from the homepage.

No	Name	Description
1	Windows Driver	This is an install program used to print a Mobile printer in Windows OS.
2	Linux Driver	This is the Cups Driver used to print a Mobile printer in the Linux environment.
3	OPOS Driver (ESC/POS)	This is a driver that controls Mobile printers using the OPOS standard. It can be used after initial setting(Mobile Printer&MSR) using the setting tool.
4	JavaPOS Driver (ESC/POS)	JavaPOS driver is an interface standard for POS software written in Java, and can be used in Mobile Printer when printing a receipt.
5	Mac Driver	This is the Cups Driver used to print a Mobile printer in the Mac OS environment.
6	Android Plugin (Sewoo Print Service Plugin) (ESC/POS)	This is a print service plug-in that allows you to print documents, images, and web pages without installing additional apps.
7	Windows SDK	This is library for communication and data output with Mobile printer in Windows OS.
8	Android SDK	This is library for communication and data output with Mobile printers in Android OS.
9	iOS SDK	This is library for communication and data output with Mobile printers in iOS.

PATENT

