



For Android™ 11

Enterprise Mobility

PM86

User Manual

Instruction

This manual provides information about basic features and using the PM86. Please read this manual carefully before using your useful handheld terminal.



Note: *Screenshots in this manual may differ from actual screens.*

Revision History

Revision	Date	Description
V1.0	14 Apr 2023	Initial release
V2.0	28 Jul 2023	Updated SKU list and description Updated accessories chapter Added Enterprise Hot Swap description Removed unsupported scanner description

Instruction

PM86 SKUs

The contents of this manual can cover the following SKUs.

SKU	Part Number	Scanner	Front Camera	SAM	Wireless	Etc.
SKU1	PM86X3Z0xDJE07	N3603			Wi-Fi	4G/64G RAM/Flash NFC Android 11 (GMS) BLE Beacon
SKU2	PM86X3Y0xDJE07	N6703				
SKU3	PM86X6Z0xDJE07	N3603			LTE, Wi-Fi	
SKU4	PM86X6Y0xDJE06	N6703	O			
SKU6	PM86X6Y0xDJE08	N6703	O	O		

Table of Content

INSTRUCTION	1
Revision History	1
PM86 SKUs	2
GETTING STARTED	8
Device Parts	8
Product Standard Accessories.....	10
Install SD & SIM & SAM cards.....	11
Card slot cover	12
Install SD card	13
Install SIM card.....	14
Install SAM card	15
Install & Remove Battery	16
Install the battery	16
Remove the battery	17
Battery hot swap.....	18
Enterprise hot swap.....	18
Legacy hot swap.....	18
Charge the Device	19
Battery specification	19
Charging temperature.....	19
Charge with power adapter.....	20
Charging Cradle	21
LED Indicator	22
Turn On / Off the Device	23
Use a Touch Screen	24
Controlling the touch screen	24
System navigation	26

Table of Content

Navigation bar (Software button)	26
Gesture Navigation	27
LEARNING THE BASICS	28
Setup Wizard	28
Home Screen	29
Status bar	30
Status icons	30
Notification icons	31
Notification panel	31
Quick setting panel	32
Apps & Widget	33
App folder	33
App drawer	34
Favorites tray	34
Organize app in Home screen	35
Widget	36
Call	37
Making a call	37
Answering a call	39
Contacts	40
Add a contact	40
Add a contact via dialer	40
Add a contact via contacts app	40
Contact detail	41
Message	42
MTP Connection with PC	43
Manage the Files	44
Lock the Screen	46
Settings	47

Table of Content

Adjust display brightness	47
Adjust sound	47
Adjust font size	48
USING THE BUTTONS	49
Screenshot.....	49
Program buttons	49
CAMERA	50
SCANNER	51
Turn on / off the Scanner	51
ScanSettings.....	52
Basic.....	52
Options	53
Notification.....	54
Wedge	55
Extended wedge.....	56
Symbologies	60
About	60
Scan a Barcode	61
ScanDemo	62
WIRELESS	63
Mobile Network	63
Wi-Fi	64
Bluetooth.....	65
Turn on / off	65
Pair and Connect.....	65
Unpair and Disconnect	66

Table of Content

Change the Bluetooth device details	67
BLE Beacon.....	67
NFC	68
SYSTEM MAINTENANCE	69
System Information	69
On Settings.....	69
On EmKit	69
Check Device Health	70
OS Update	71
OS update via storage	71
OS update via OTG port.....	72
OS update via FOTA	72
Factory Data Reset.....	74
Factory data reset via Settings app	74
Factory data reset via recovery mode	75
ACCESSORIES.....	76
Hand Strap.....	76
Mount hand strap.....	77
Rugged Boot.....	79
Attach rugged boot	79
Detach rugged boot	81
Gun Handle.....	82
Attach gun handle.....	82
Attach gun handle hand strap.....	83
Charging Cradle.....	85
Single Slot Cradle (SSC / SEC).....	85
2SC (2 Slot Cradle)	86
4SBC (4 Slot Battery Cradle).....	87

Table of Content

SAFETY INFORMATION.....	88
Battery Safety Information	88

Getting Started

Device Parts

Figure 1 PM86 front + left view

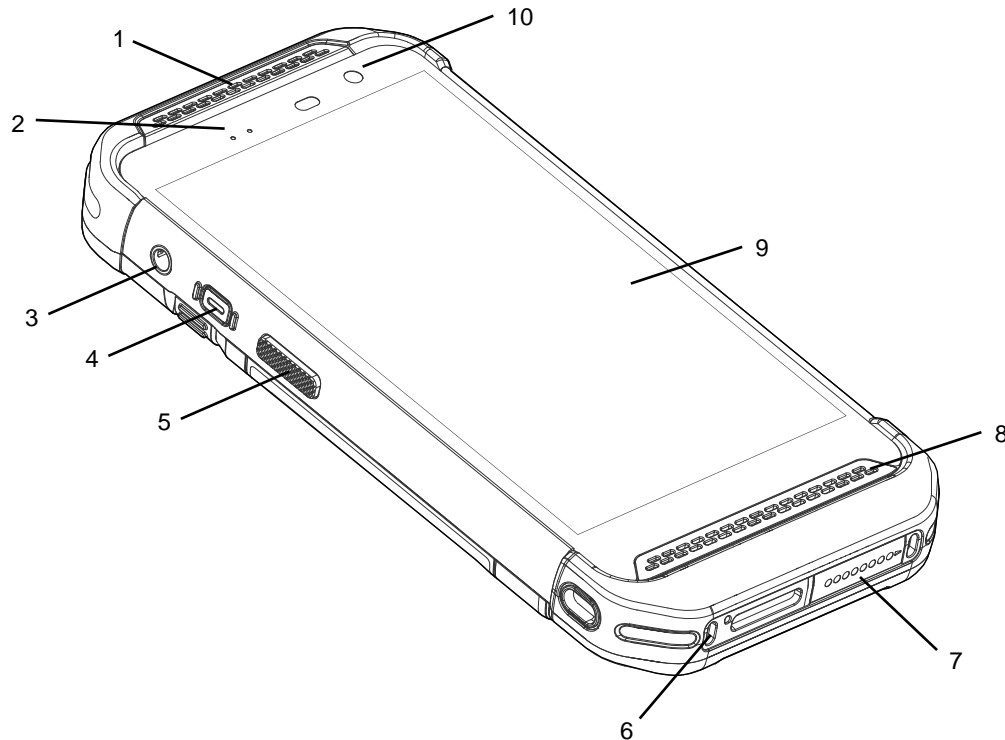

No	Name	Description
1	Receiver	Use with making a phone call
2	LED indicator	Indicate the power status and notification. Find more details in LED indicator
3	Audio jack	Connect headset
4	Power button	Turn on/off the device
5	Scan button (Left)	Scan a barcode by pressing (Programmable button)
6	Microphone	Use for collecting sound
7	I/O connector for cradle	Connector for charging and communication with cradle
8	Speaker	Ring system sound
9	Touch screen	Displays all operating screen
10	Front camera	Take a picture (only for SKU 4, 6)

Getting Started

Figure 2 PM86 rear + right view

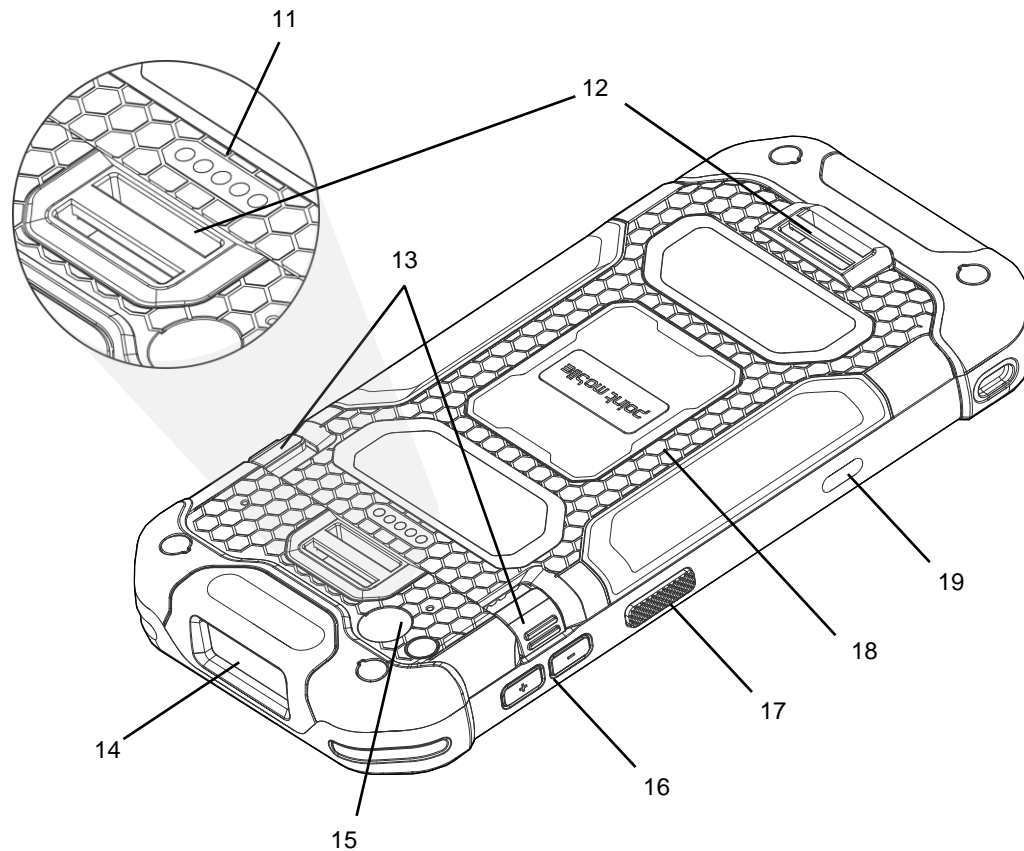

No	Name	Description
11	Rear I/O connector	Connector for gun type accessories
12	Hand strap hole	Mount hand strap
13	Battery release button	Press the buttons in to release the battery
14	Scanner	Scan a barcode
15	Rear camera & Flashlight	Take a picture & Use flashlight in camera or torch mode
16	Volume buttons	Control the volume (Programmable button)
17	Scan button (Right)	Scan a barcode by pressing (Programmable button)
18	Battery	Provide power (battery and battery cover are combined)
19	USB connector	USB Type C connector for charging and data communication

Getting Started

Product Standard Accessories

The following items are in the product box.

Accessory	Name
	Battery pack
	5V 2A power adapter
	AC plug
	USB type C cable
	LCD protection film
	Hand strap



Note: The images may differ from the actual accessory.

Getting Started

Install SD & SIM & SAM cards

PM86 supports

- microSD card
- Nano SIM card – LTE SKU (SKU3 ~ 6) only
- SAM card – SKU 6 only

You can find the card slots when removing the battery. Depending on SKU, the equipped card slots are different. Refer to the following table.

Figure 3 PM86 Card Slots

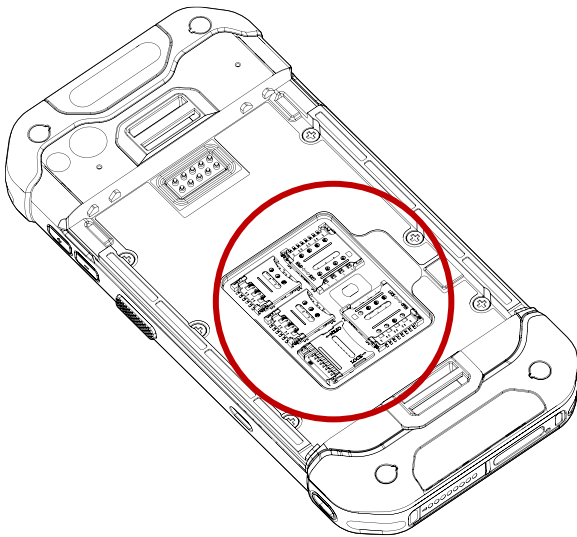

Wi-Fi SKU (SKU 1~2)	LTE SKU (SKU 3~4)	LTE + SAM SKU (SKU 6)

Getting Started

Card slot cover

You must open the card slot cover to install or remove the cards. The slot cover protects the device from water, dust, etc.

To open the cover, pull it out using the handle on the right side.

After installing or removing cards, place the cover on the card slot(s) and push the edge to close firmly.



Notice: Do not throw away the cover. It affects device sealing performance against water, dust, etc.

Figure 4 Card slot cover

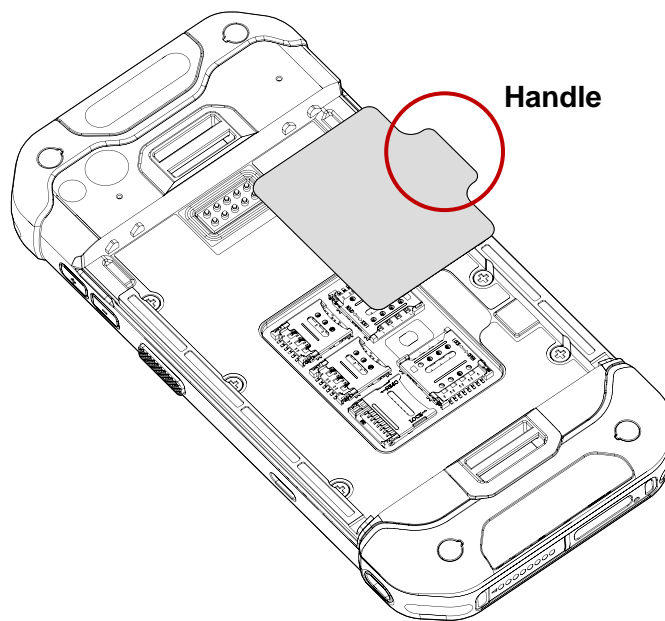

Getting Started

Install SD card

1. Remove the battery and open the card slot cover.
2. Gently slide the cardholder **left**, and swing upwards to open the holder.

Figure 5 Open SD cardholder

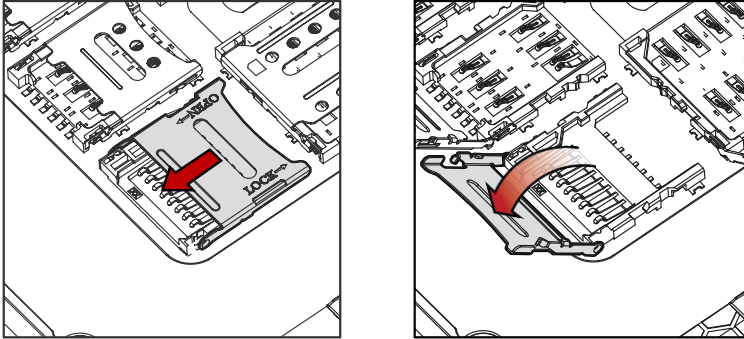

3. Put the SD card you prepared with the contacts facing down.

Figure 6 Place SD card

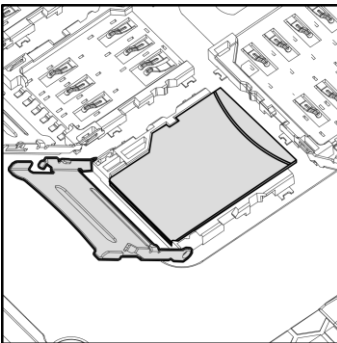

4. Close the holder down and gently slide it right to lock the holder.

Figure 7 Close SD cardholder

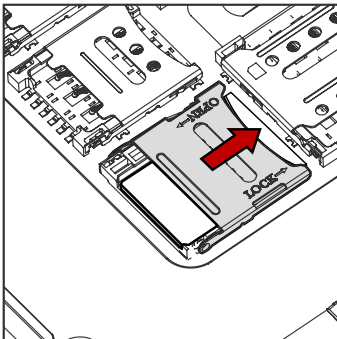

5. Close the card slot cover firmly.

Getting Started

Install SIM card

1. Remove the battery and open the card slot cover.
2. Gently slide the cardholder **left**, and swing upwards to open the holder.

Figure 8 Open SIM cardholder

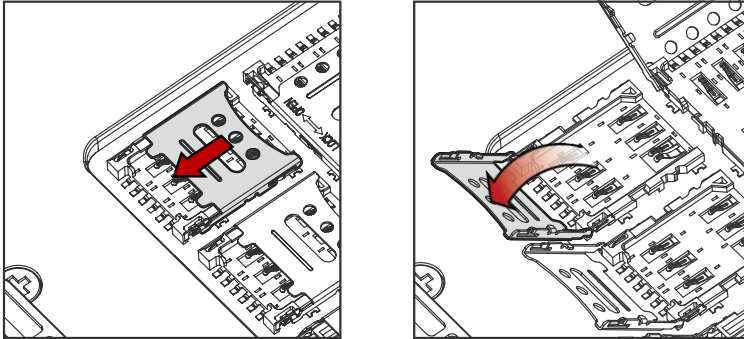

3. Put a nano SIM card you prepared with the contacts facing down.

Figure 9 Place nano SIM card

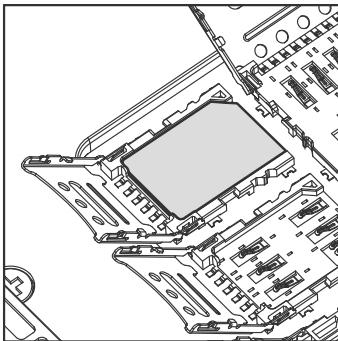

4. Close the holder down and gently slide it right to lock the holder.

Figure 10 Close SIM cardholder

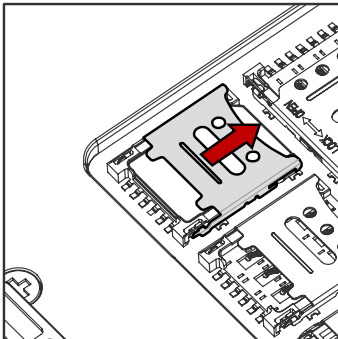

5. Close the card slot cover firmly.

Getting Started

Install SAM card



Note: PM86 SKU 6 includes two SAM slots, on the top and bottom.

All directions to open/close the cardholders are opposite each other. In this chapter, the figures indicating the **top** SAM slot are used.

1. Remove the battery and open the card slot cover.
2. Gently slide the cardholder **up**, and swing upwards to open.

Figure 11 Open SAM cardholder

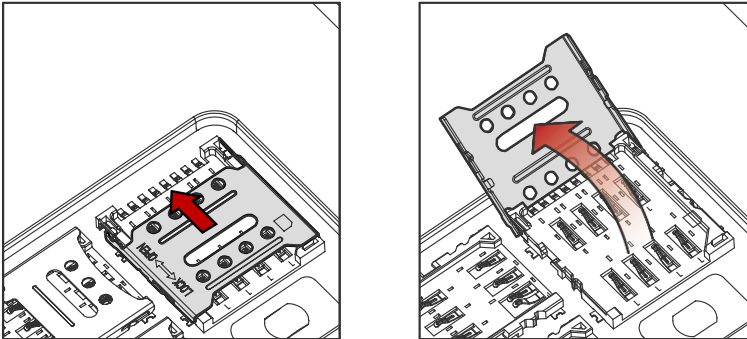

3. Put the SAM card you prepared with the contacts facing down.

Figure 12 Place SAM card

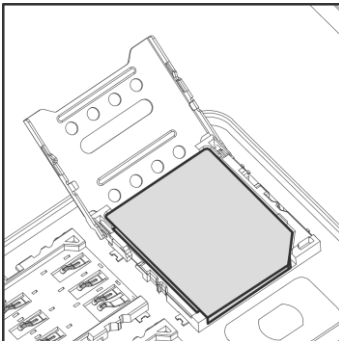

4. Close the holder down and gently slide it down to lock the holder.

Figure 13 Close SAM cardholder

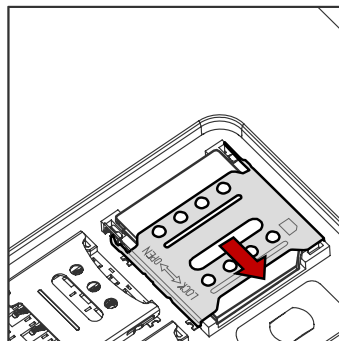

5. Close the card slot cover firmly.

Getting Started

Install & Remove Battery

Install the battery



Caution: Make sure the cardholders are completely closed before installing the battery.

It may damage the device if you force to install the battery while the cardholders are not closed.

1. Insert the battery from the bottom side (opposite side of the battery release buttons).

Figure 14 Installing battery - 1

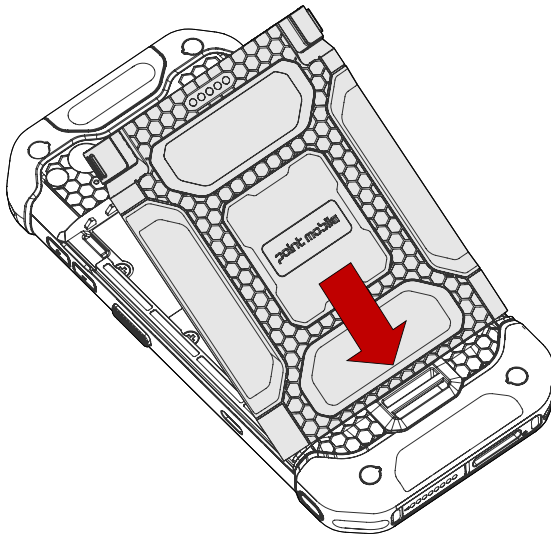

2. Push the battery down until it clicks.

Confirm that the battery release buttons are completely outward.

Figure 15 Installing battery - 2

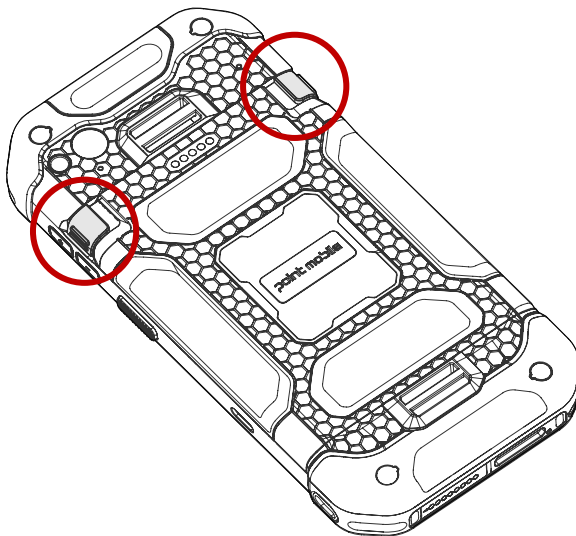

Getting Started

Remove the battery

1. Hold the battery release buttons and press in.

Figure 16 Removing battery - 1

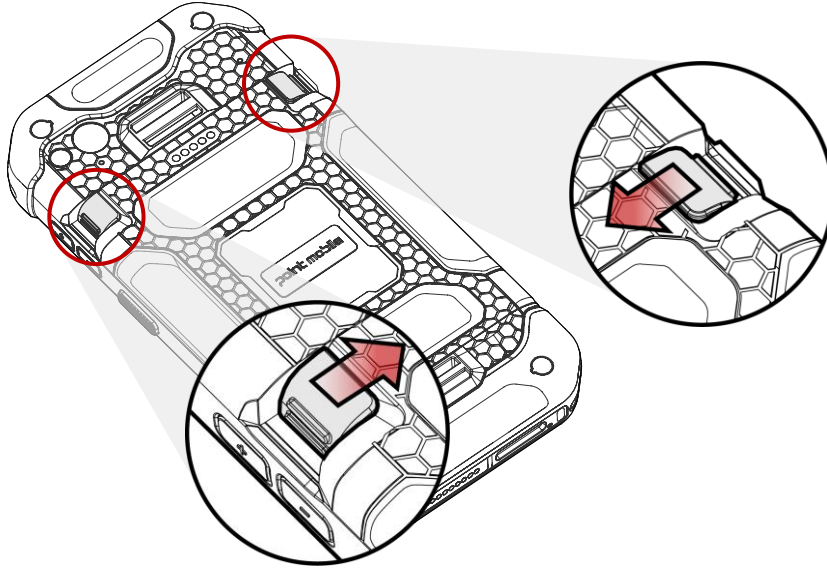

2. While pressing the battery release button in, pull the battery up.

Figure 17 Removing battery - 2

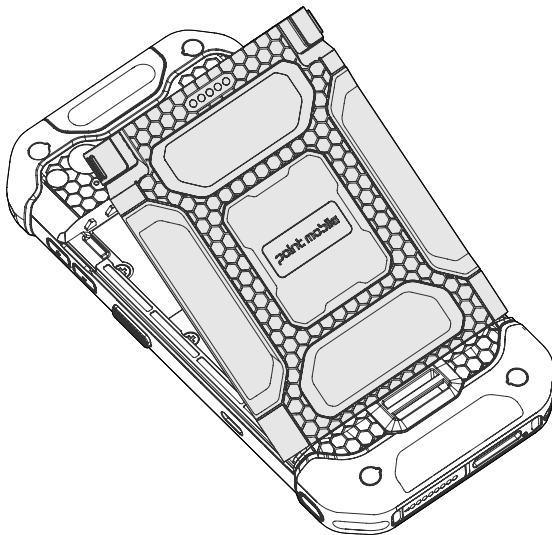

Getting Started

Battery hot swap

Battery hot swap is a feature that allows users to replace the battery without powering off. PM86 supports two types of hot swap mode, Enterprise hot swap, and Legacy hot swap. Basically, the device enters Enterprise hot swap mode. You can change the preferred hot swap mode in EmSettings.

Enterprise hot swap

Enterprise hot swap allows the device to maintain Wi-Fi/Bluetooth connectivity and memory persistence even when detaching the battery. Users can earn time to replace the battery without stopping the ongoing task or disconnecting the Bluetooth devices.

But, as the backup battery with a smaller capacity than the main battery takes over to maintain the system, users are highly recommended to replace the battery within 30 seconds (30 seconds countdown displays). And some mitigations are activated to conserve power consumption.

- Reducing display brightness to about 10%
- Disabling NFC, Scanner
- Lowering sound volume

Once the user replaces the battery with a charged one, the device will come back to normal operation mode without booting process.



Notice: Do not change any settings or perform actions that may increase power consumption for device stability.

Legacy hot swap

When the battery is removed from the device, the display turns off and the device waits for battery replacement.

Once the user replaces the battery with a charged one, the device will come back to normal operation mode without booting process.

Getting Started

Charge the Device

Before using PM86, charge the device enough to use. PM86 can be charged with power adapter or charging cradle. For best charging performance and safety, follow the normal [charging temperature](#).



Caution: Always use an original charger and cable from Point Mobile. Other chargers and cables may damage PM86. Also, make sure the charger and cables are not wet.

Follow the [Battery Safety Information](#) for safety of using the battery.

Battery specification

- Capacity:
 - Standard battery: 4,080mAh
 - Extended battery: 5,800mAh
- Rechargeable & Removable battery

Charging temperature

Charge devices and batteries in temperatures from 0 °C to 45 °C. At out-of-normal range temperatures, the PM86 may stop charging for safety, and the power LED blinks red.

Getting Started

Charge with power adapter

1. Assemble the country plug, power adapter and USB type C cable.
2. Connect the cable to the USB connector on the right side of PM86.
3. Provide power by plugging the power adapter to the wall socket.

Figure 18 PM86 charging with power adapter

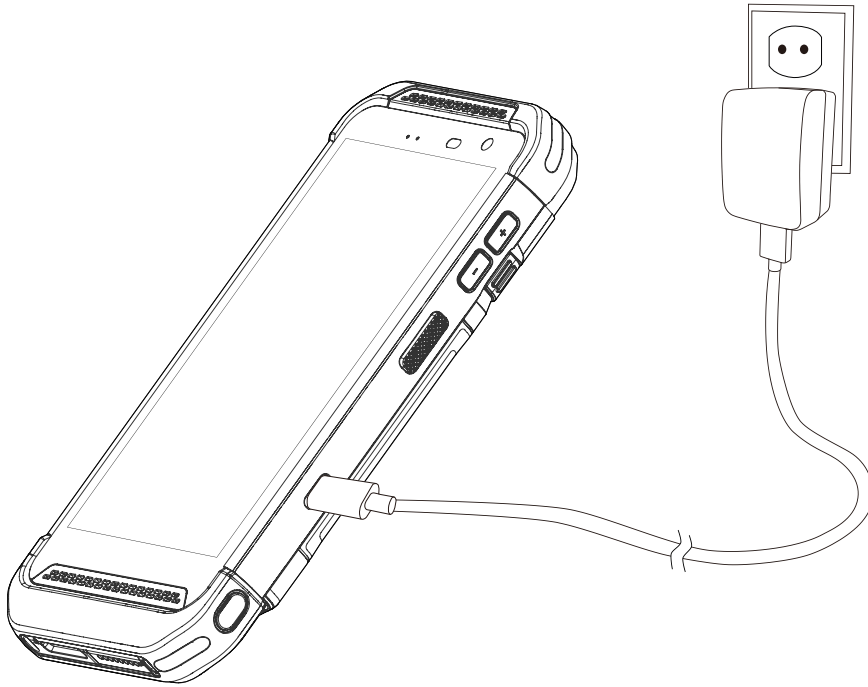

Getting Started

Charging Cradle

There are two types of charging cradle for PM86. Single slot (ethernet) cradle (SSC / SEC), 2 slot cradle (PM85 2SC), 4 slot battery cradle (4SBC). The cradles are sold separately.

When the device is charging via cradle, the charging animation as below is displayed on the screen. (Refer to [Charge with Cradle](#) for more detail)

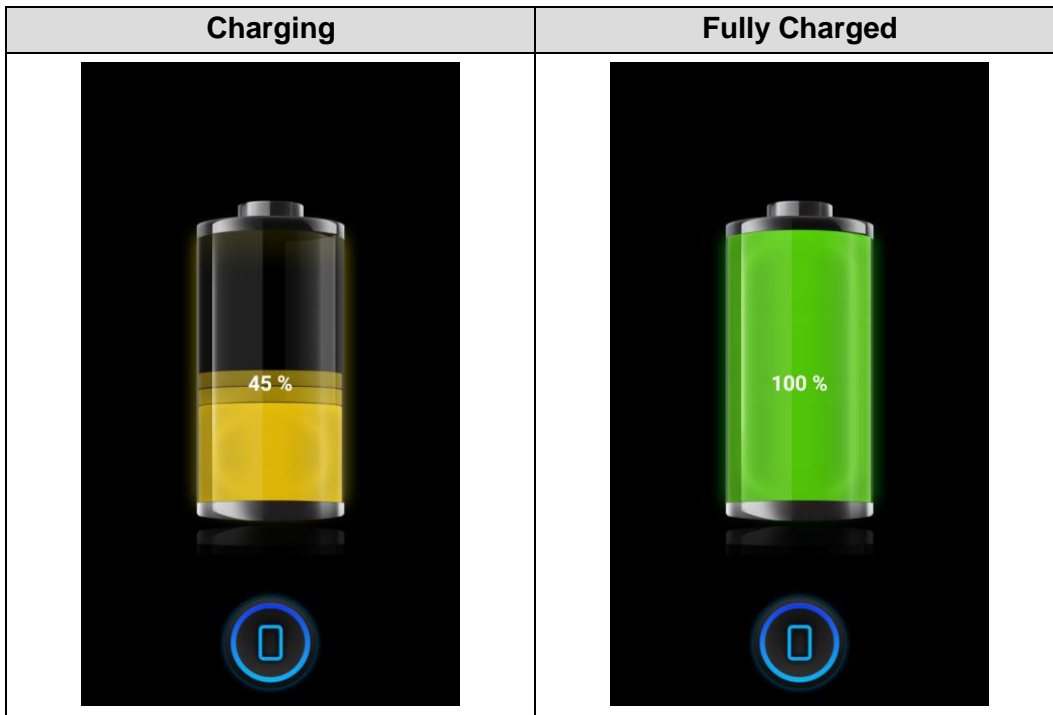







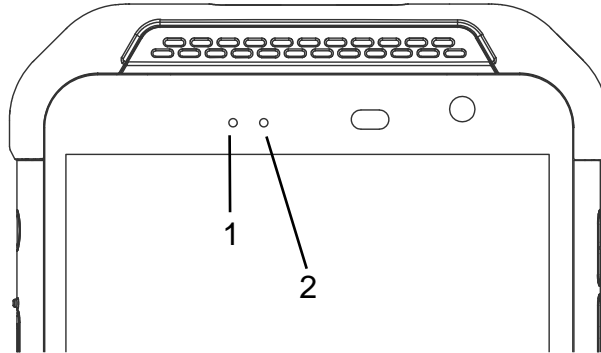

Getting Started

LED Indicator

PM86 has 2 LED indicators above the screen.

Figure 19 PM86 LED indicators



No	Indicator	Status	Indication
1	Power LED	 Solid green	Device is completely charged
		 Solid red	Device is charging / Battery is low
		 Blinking red	Charging temperature is out-of-normal range (Refer to Charging temperature) / Battery is very low
		 Alternately blinking red & green	Cannot recognize the battery
2	Notification LED	 Blinking blue	Notification existing
		 Red flash	Barcode reading failed
		 Blue flash	Barcode reading success

Getting Started

Turn On / Off the Device

To turn on the device,

- Press and hold the power button on the left side of the PM86 until **SMART BEYOND RUGGED** logo displays on the screen.

Figure 20 PM86 power button

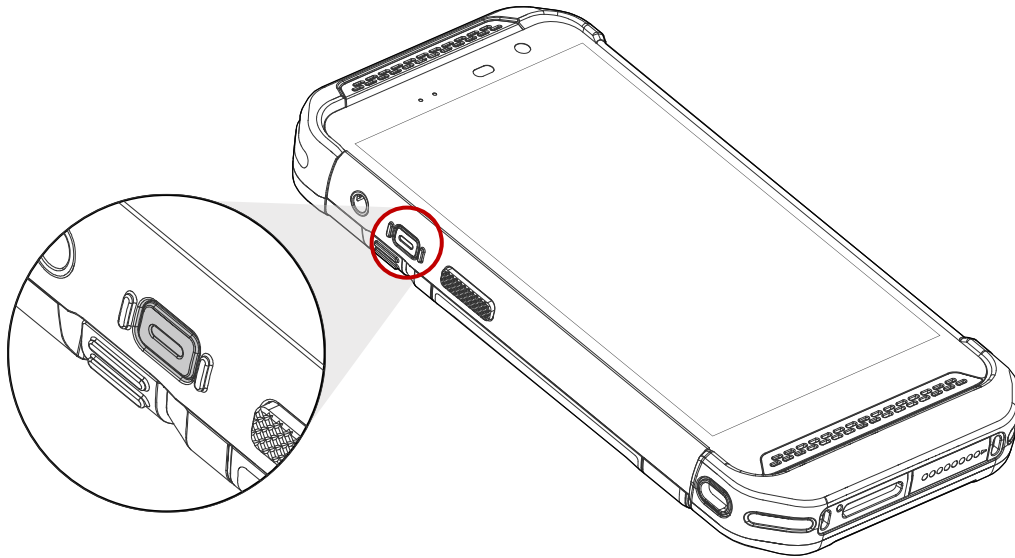

To turn off the device,

- Press and hold the power button when the display is on until the power menu is shown. Then, tap **Power > Power off**.

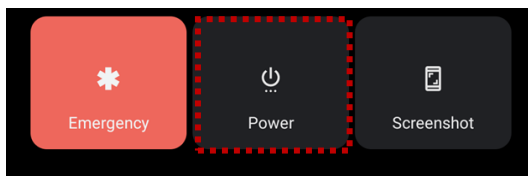
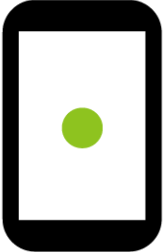

Figure 21 Power menu - Power off



Getting Started

Use a Touch Screen

Controlling the touch screen

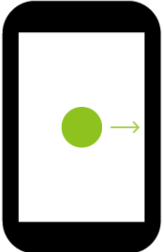
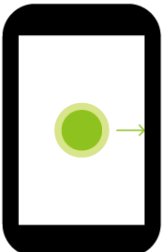
Gesture	Description
	<p>Tap One-finger press</p>
	<p>Double tap One-finger press, lift, one-finger press, lift for zoom in action</p>
	<p>Long-press One-finger press, wait, lift for select action</p>
	<p>Drag, Swipe, or Fling One-finger press, move, lift for scroll or tilt action</p>
	<p>Long-press drag One-finger press, wait, move, lift for pick up and move, or select multiple items action</p>

Getting Started

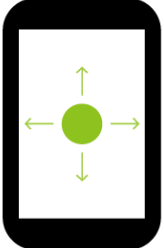
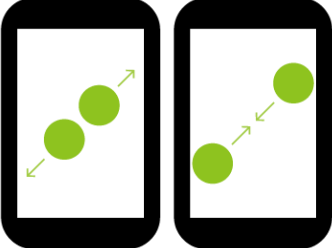
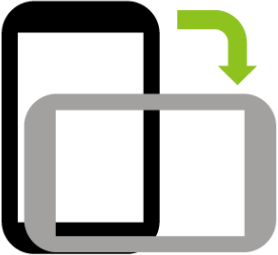
Action	Description
	<p>Scroll Vertical or horizontal swipe in a single direction</p>
	<p>Pinch Open & Close Two-finger press, move outwards and inwards, lift for zoom in / out action</p>
	<p>Rotate When PM86 is turning sideways, screen orientation is changing</p>

Getting Started

System navigation

Navigation bar (Software button)

The navigation bar is enabled as a default, and it is located at the bottom of the screen. The app overview button, home button, and back button are placed on the bar in order.

Figure 22 Navigation bar

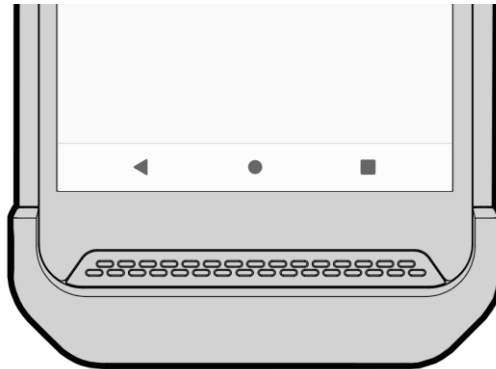



Shape	Button	Function
◀	Back button	Tap to go back to previous screen.
●	Home button	Tap to go to home screen. Long-press to launch the Google Assistant.
■	Recent apps button	Tap to see the recently used app list.

Getting Started

Gesture Navigation

If you are unfamiliar with the navigation bar or you want to see the screen with a wider screen, hide the navigation bar. The functions provided by the software buttons on the navigation bar can be used by using specific gestures.

To hide the navigation bar, navigate to **Setting**  > **System**  > **Gesture** > **System navigation** and change the setting to **Gesture navigation**. Then, the navigation bar will be hidden.

 **Note:** To use the navigation bar again, change the setting to **3-button navigation**.

Figure 23 Gesture navigation



Find the gestures and matched function in the table below.

Function	Gesture
Open recent apps screen	Swipe up from the bottom of the screen, hold, then release.
Go to home screen	Swipe up from the center-bottom of the screen.
Back to previous screen	Swipe from the left or right edge of the screen.
Launch Google Assistant	Swipe up from either the left-bottom or right-bottom.

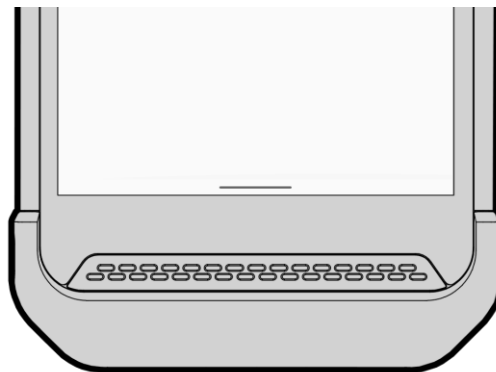
Learning the Basics

Setup Wizard

When PM86 starts very first time or boot after factory reset, Setup Wizard is launched. Following the steps on the screen, set system language, Google account, Wi-Fi connection and copy the data, etc.

Some settings can be skipped, but there may be some restrictions on the use of the system.

Figure 24 Setup Wizard (main)

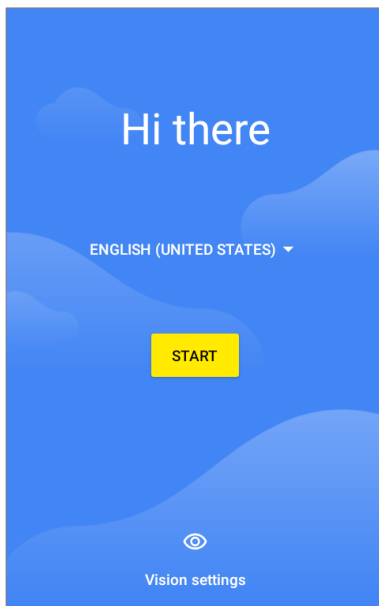
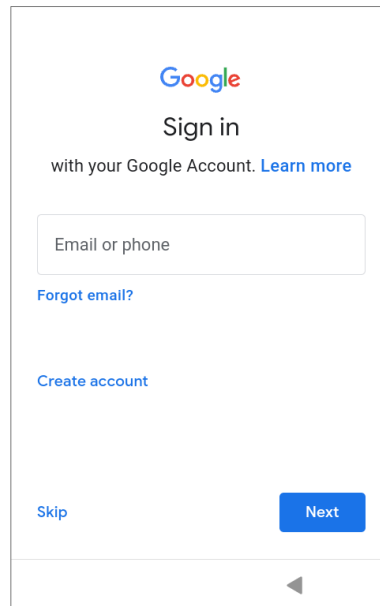

Figure 25 Setup Wizard (Google account)



Learning the Basics

Home Screen

Home screen is a screen displayed after Setup Wizard or pressing the Home button.

Figure 26 Home screen

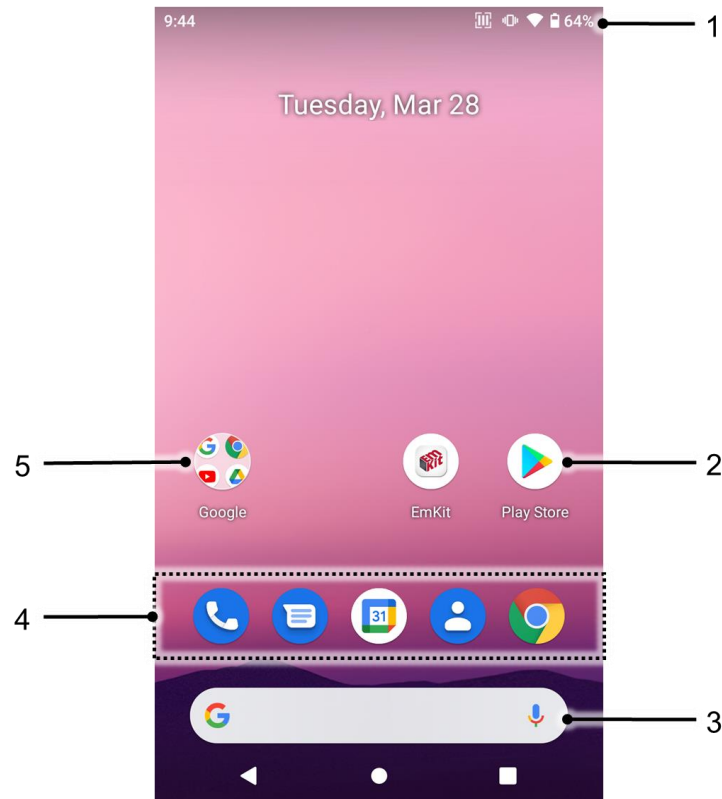



























No	Item	Description
1	Status bar	Indicates device status and notification.
2	App	Tap to run the application Long-press to see the application's options
3	Google search	Search an item with Google
4	Favorites tray	Place the frequently used apps
5	App folder	Apps are organized in the folder. Tap to open the App folder

Learning the Basics

Status bar











Time, status icons, and notification icons are on the Status bar.

Status icons

Icon	Description	Icon	Description
	LTE connected		Strong signal
	3G connected		Weak signal
	EDGE connected		Connection issue
	LTE+ (LTE CA) connected		Data disabled
	Hotspot enabled		No data connection
	Airplane mode		Connected to a Bluetooth device
	Connected to a Wi-Fi network		Wi-Fi data communication
	Battery is full		Battery is low
	Battery is critical low		Cannot recognize battery
	Battery is charging		Alarm is set
	Location service turned on		Vibrate mode
	Speakerphone turned on		Phone mic is mute
	Scanner turned on		Scanner turned on, but trigger turned off

Learning the Basics

Notification icons

Icon	Description	Icon	Description
	Missed call		New SMS or MMS message
	New Email		Connected to VPN network
	Upcoming event		Other input method available
	File uploaded		File downloaded
	File copied		OTG device connected
	There are more notifications		

Notification panel

Notification panel displays a list of all notifications. Tap a notification to respond.

To open the Notification panel, drag the Status bar down. To close the panel, swipe it up.

Figure 27 Notification panel

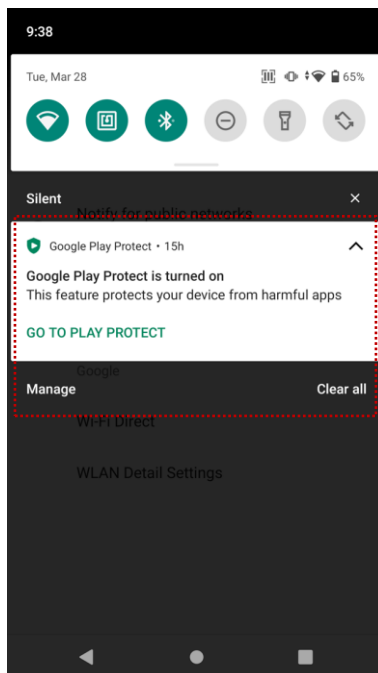

Learning the Basics

Quick setting panel

Quick setting panel contains some frequently used settings such as Wi-Fi, Bluetooth, etc.

To use the Quick setting panel,

1. Open the Notification panel.
2. Drag down the Notification panel.
3. Tap a setting icon to enable / disable the setting or long-press an icon to see more detail.

Figure 28 Quick setting panel

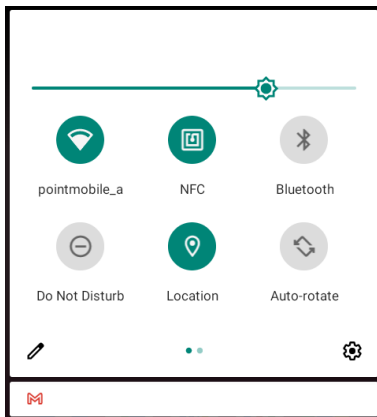

To edit the configuration of Quick setting panel,

1. Tap  on the bottom of the panel.
2. By long-press and dragging the icon, customize the configuration of the panel.

Learning the Basics

Apps & Widget

App folder

To create the app folder, long-press an app icon and drag it to another app icon.

Figure 29 Create app folder



To change the folder name, tap the **Edit Name** and input a new name.

Figure 30 Change app folder name

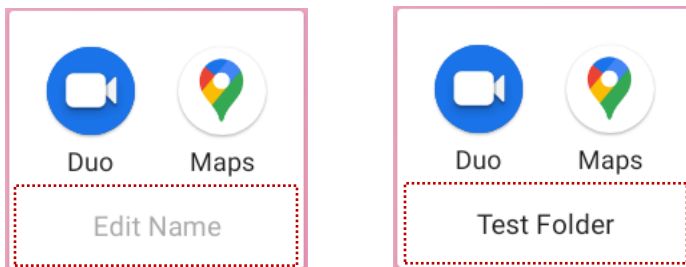

Learning the Basics

App drawer

All installed apps are listed alphabetically in App drawer.

- To open the App drawer, swipe up the Home screen.
- To close the App drawer, swipe down the Home screen.

Figure 31 App drawer

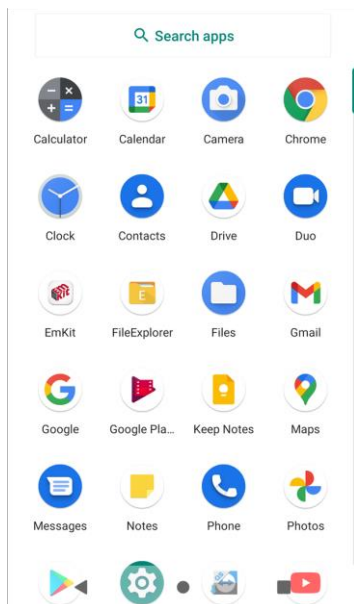

Favorites tray

To organize an app in the Favorites tray,

1. Long-press an app icon from the App drawer. Then, drag it slightly until the Home screen is shown.
2. Place the app icon in the Favorites tray.

Figure 32 Add an app to Favorites tray

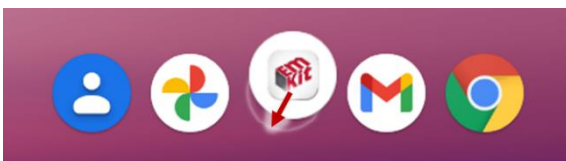

Learning the Basics

Organize app in Home screen

To organize an app in the Home screen,

1. Long-press an app icon from the App drawer. Then, drag it slightly until the Home screen is shown.
2. Place the app icon where you want.

(To cancel to place the app, drag it to **Cancel** area and release.)

Figure 33 Place app in Home screen

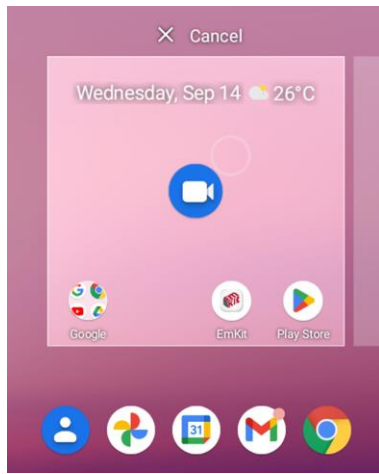

To remove an app or widget in the Home screen,

1. Long-press an app icon or widget.
2. Drag it to **Remove** area and release.

Figure 34 Remove from Home screen

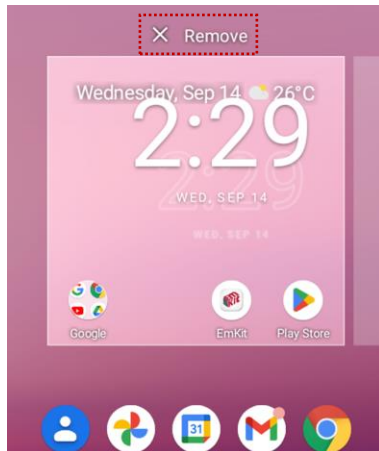

Learning the Basics

Widget

To add a widget in the Home screen,

1. Long-press the empty space of the Home screen.
2. In three menus, select **Widgets**.

Figure 35 Widget menus

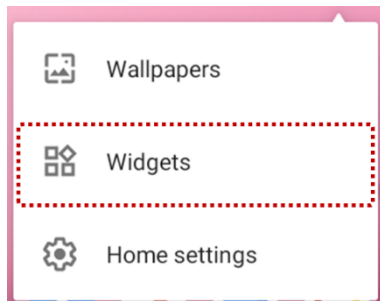

3. Among the list, tap and hold a widget you want to add.
4. Place the widget to the Home screen by dragging.



Note: To remove an app or a widget from the Home screen, long-press and drag it to Remove area.

Figure 36 Remove from Home screen



Learning the Basics

Call

 **Note:** Calling is only available on LTE SKU (SKU3 ~ 6).

To make or receive a phone call, SIM card is required. Insert SIM card to PM86 first regarding [Install SD & SIM & SAM cards](#).

Making a call





1. Tap **Phone**  from Home screen or App drawer.
2. Tap  to open a dialer.
3. Input a phone number.

Figure 37 Dialer





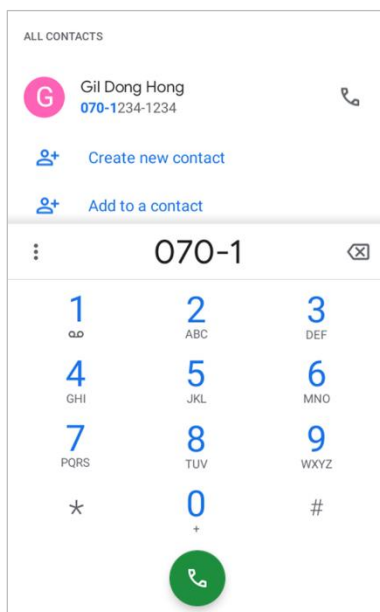

4. Tap  or  next to a searched number to make a call.

Learning the Basics

5. Control the Tap  to hang up the phone.

Figure 38 Calling screen



Icon	Function Name	Description
	Mute	Mute microphone
	Keypad	Open the keypad
	Speaker	Speakerphone mode
	Add call	Add another call (Enable when receiver answer the phone)

Learning the Basics

Answering a call

Check the caller's name and number and tap **ANSWER** button to answer the phone call. Or tap **DECLINE** button to decline the phone call.

Figure 39 Receiving call

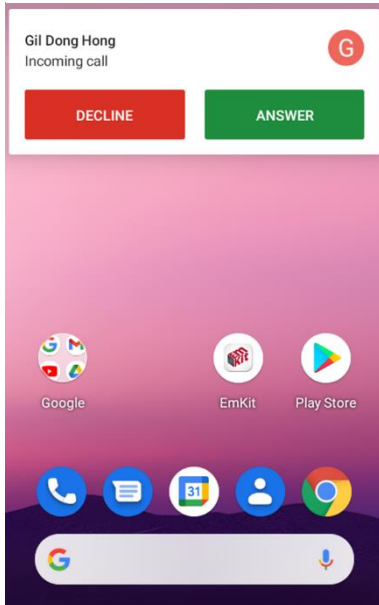

Learning the Basics

Contacts

Add a contact

Add a contact via dialer

1. Navigate to dialer through Phone, and enter the number.
2. Tap **Create new contact** or **Add to a contact** to save the number.
3. Input additional information.
4. Tap **Save**.

Add a contact via contacts app

Navigate to **Contacts**  from App drawer and tap  to add a new contact.

Figure 40 Add new contact via Contacts



Enter the contact details and tap **Save**.

Learning the Basics

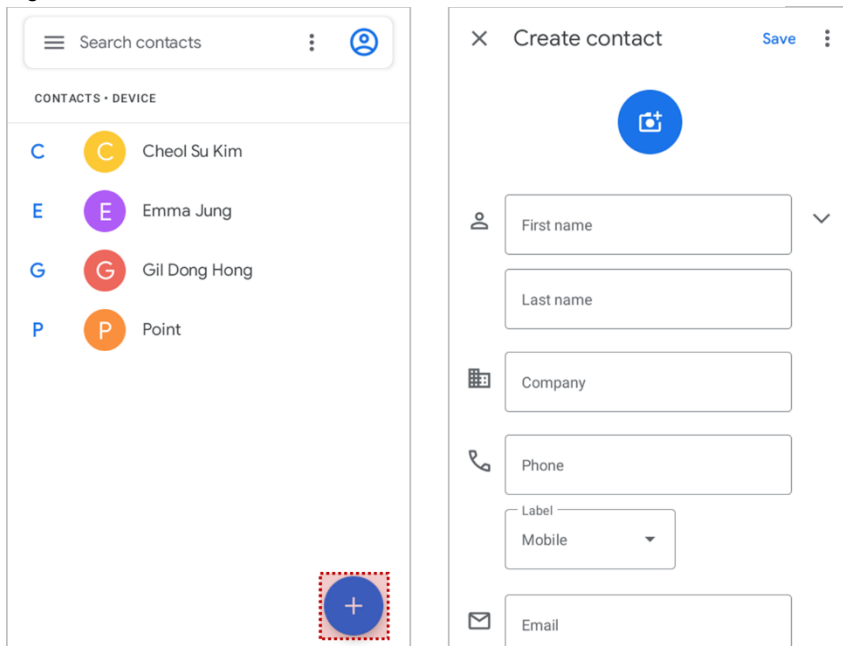
Contact detail

Select a contact from the list to find more detail information.

Figure 41 Contact detail

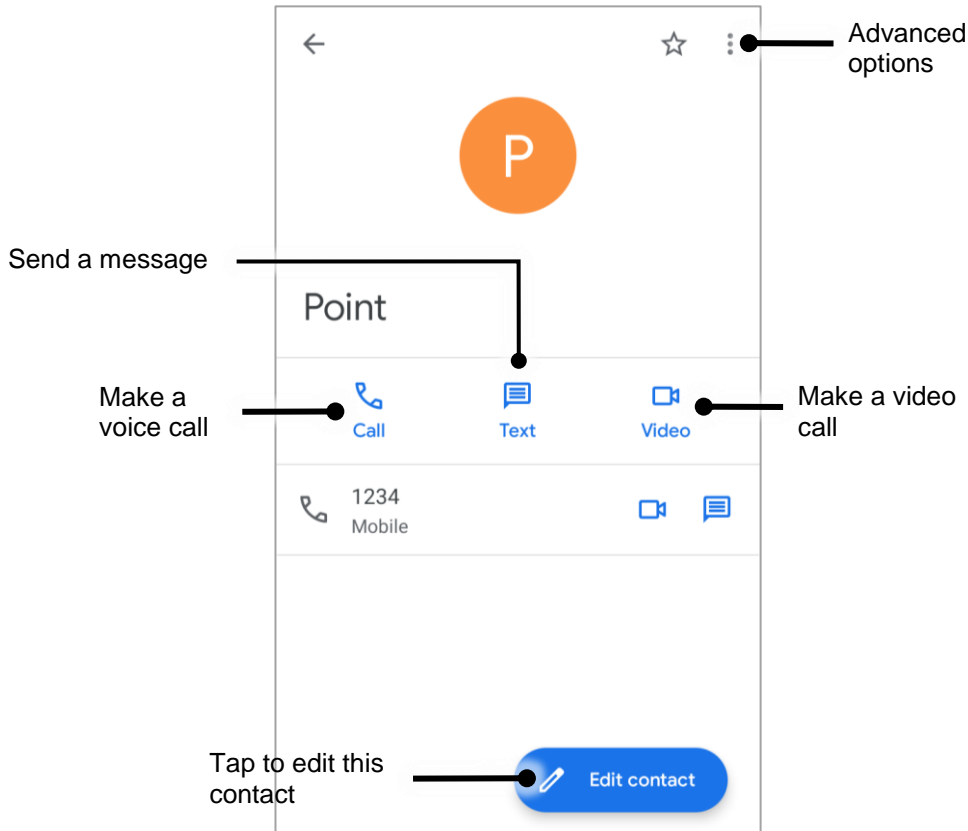

Tap  to open advanced options such as delete, share, block, etc.

Figure 42 Contact advanced options



Learning the Basics

Message

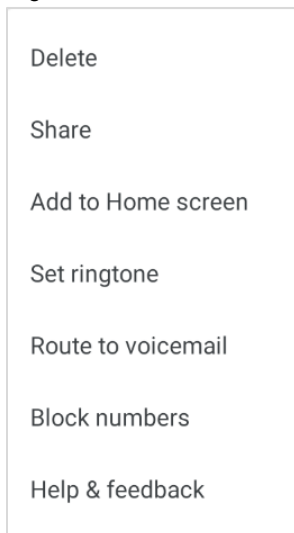
Note: Message feature is only available on LTE SKU (SKU3 ~ 6). And it requires a SIM card.

Send a message or find the received message through Message application .



1. Launch **Message**  from App drawer.
2. Tap **Start Chat** and type the receiver's name or phone number.

Figure 43 Message list

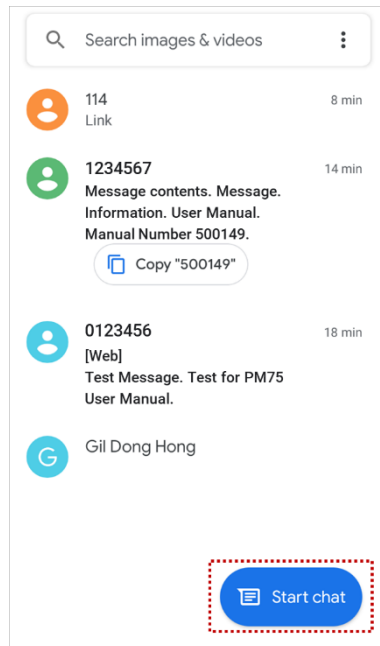

3. Input a message.
4. Tap  icon to send.

Learning the Basics

MTP Connection with PC

To transfer the files with a PC, connect the device to the PC via USB cable first.

1. Drag down Status bar and tap **Android System** notification to change USB preference option.

Figure 44 USB connection notification

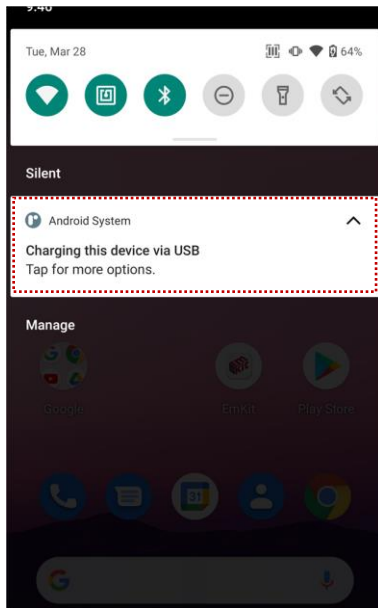

2. Change the option to **File Transfer** from **No data transfer**.

Figure 45 USB Preferences

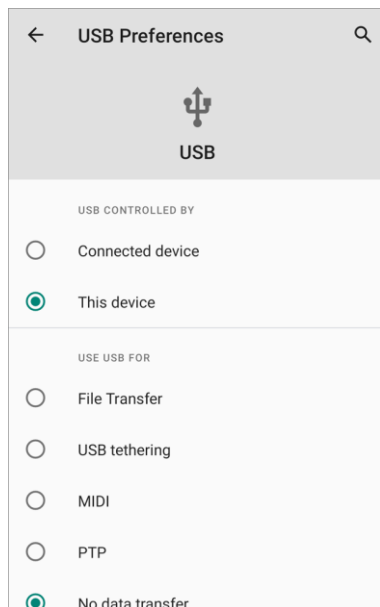

Learning the Basics

3. Now PC can recognize the connected device. Find PM86 device from file explorer of the PC.

Figure 46 File explorer on PC

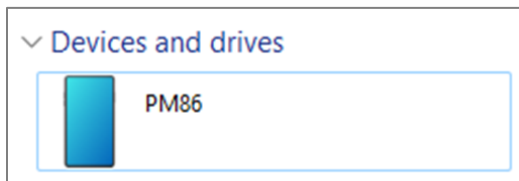

Manage the Files

Figure 47 FileExplorer main screen

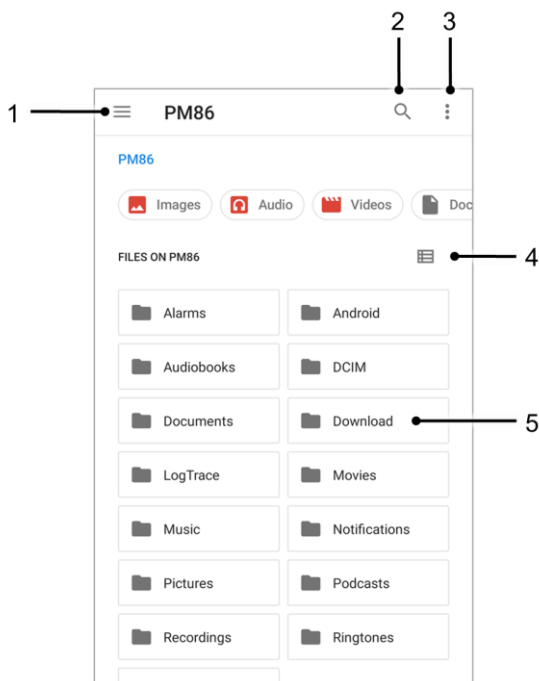

No	Description
1	Select media file type or storage
2	Search a file
3	Open the advanced option – Create a new window or folder, Select all files and folders, etc.
4	Change the view of file list
5	Tap a file or folder to open. Or long-press a file or folder to select

Learning the Basics

Long-press a file (folder) or tap the icon which is located beside of file name to select the file (folder).

Figure 48 FileExplorer screen when file selected

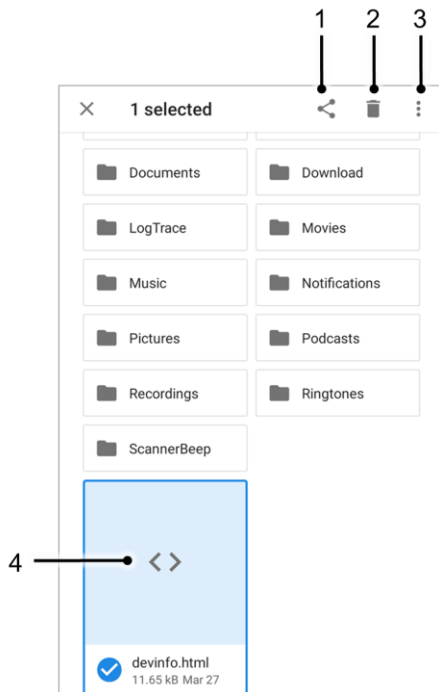

No	Description
1	Share the file via Bluetooth / Gmail / Google Drive, etc. (Sharing is possible only with files)
2	Delete the files or folders
3	Open the advanced option <ul style="list-style-type: none"> - Open with: Select which app to open the file - Sort by...: Sort the list by file name, size, type, etc. - Select all: Select all files and folders - Copy / Move to: Copy or move the file to a new location - Compress: Create Zip file with the selected files or folders - Rename: Rename the file or folder - Get info: Display the file information
4	Selected file or folder is highlighted

Learning the Basics

Lock the Screen

Protect the device from unauthorized personnel by setting up the screen lock.



1. Navigate to **Settings**  > **Security** .
2. Tap **Screen lock**.

Figure 49 Screen lock



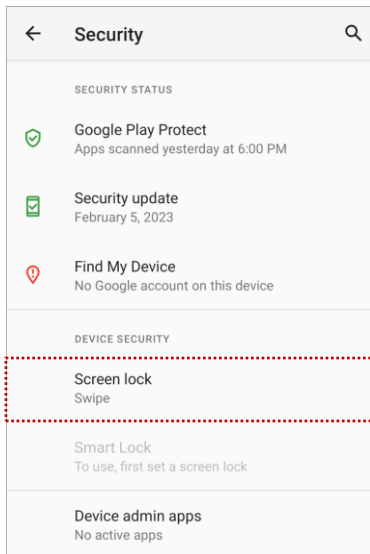

3. Choose a screen lock method.
 - None: Screen unlocks immediately
 - Swipe: Swipe the lock screen to unlock (Default)
 - Pattern: Draw a pattern to unlock
 - PIN: Input a PIN to unlock (At least 4 digits)
 - Password: Input a password to unlock (At least 4 characters)

Learning the Basics

Settings

There are two ways to go to **Settings**:

- Open the App drawer and tap **Settings** 
- Open the Quick setting panel and tap gear icon 

Adjust display brightness

To adjust the display brightness level,



- Open Quick setting panel and adjust display brightness bar
- Go to **Settings**  > **Display**  > **Brightness level**

Figure 50 Normal brightness level



Figure 51 High brightness level (higher than 80%)



Caution: Using high brightness levels for long periods may cause eye strain and increase battery consumption.

Adjust sound

To adjust sound volume, go to **Settings**  > **Sound**  and control the Media, Call, Alarm volume bars.

Figure 52 Volume bars

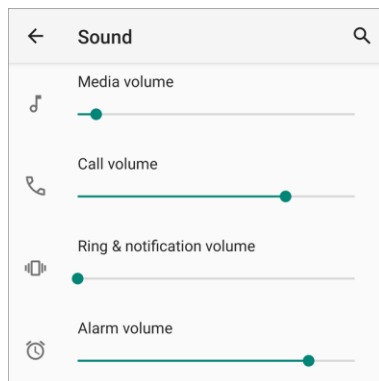

Caution: Using high volume levels for long periods may cause ear strain and increase battery consumption.

Learning the Basics

Adjust font size

If the font size of the screen is too small or too large, adjust the font size.



1. Go to **Settings**  > **Display**  > **Advanced** > **Font size**
2. Referring to the **Preview**, set the font size

Figure 53 Set font size



Using the Buttons

Screenshot

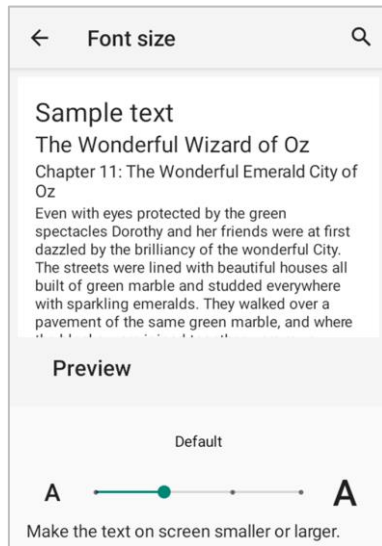
To take a screenshot, use one of the two ways as below.

- Press and hold **Power button + Volume down button** simultaneously.
- Press and hold the power button, and then tap **Screenshot** among the power menus.

The screenshot image will be saved to **Pictures > Screenshots** folder in the internal storage.

Program buttons

Most buttons on the PM86 except power button can be optimized as you want. To map the button to other functions from default,



1. Navigate to **EmKit**  > **Program Buttons** .
2. Tap **SMART REMAP**. And press a button you want to remap.

Figure 54 Program buttons - button list



Note: *SCANNER_B* indicates the trigger button on the gun handle.

3. Choose a behavior you want to use among the tabs.
4. Tap **APPLY**.

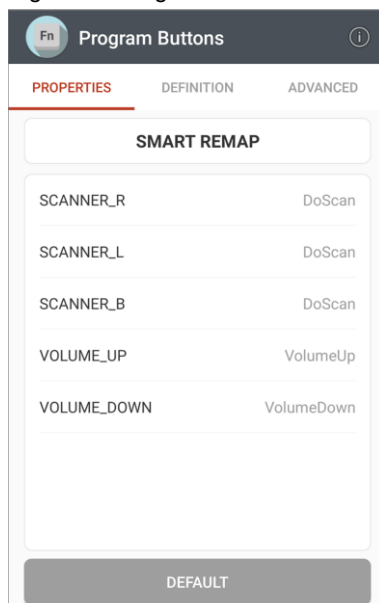
Camera

To use the camera, open App drawer and tap Camera application .

Figure 55 is a main screen of Camera application, and Figure 56 is a screen that is displayed when you swipe the screen to right.

Figure 55 Camera main screen

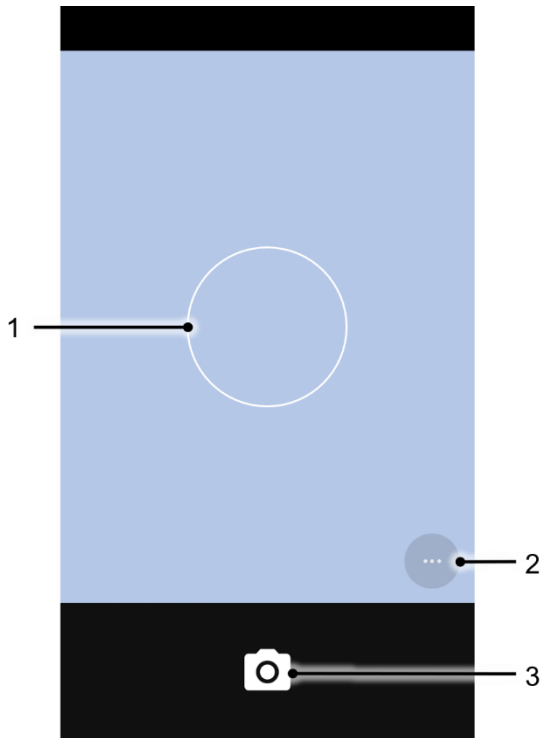
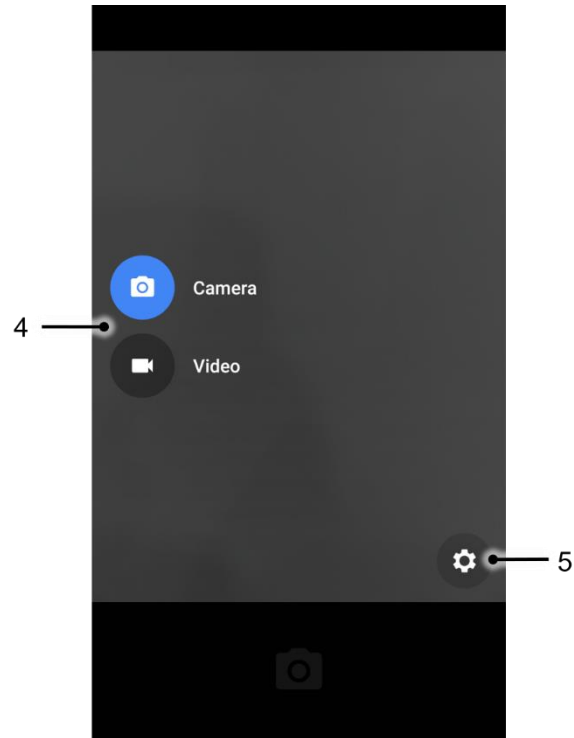





Figure 56 Camera mode change/setting screen



No	Name	Description
1	Focus zone	You can change the focusing area by touching the other area
2	Advanced camera option	 : Set timer  : Display the grid on the screen  : Set flash mode (Activate / Deactivate / Auto mode)  : Switch the camera (Front / Rear)
3	Shutter button	Take a picture or recode a video
4	Mode change button	Change the Camera or Video mode
5	Advanced camera setting	Set resolution & quality of picture Enable / Disable saving location and manual exposure



Note: Front camera is not embedded in SKU1, 2, 3.

Scanner

Scanner is placed on the top of the PM86. Optimize the scanner settings for working environment and improve the efficiency.

Turn on / off the Scanner

The scanner is turned off by default. To turn on the scanner, follow the steps.



1. Go to **EmKit**  or **Settings**  and tap **ScanSettings**.
2. Tap toggle button to turn on/off the barcode scanner.
3. Check if the scanner icon  is placed on Status bar.

Figure 57 Turn on scanner



Scanner

ScanSettings

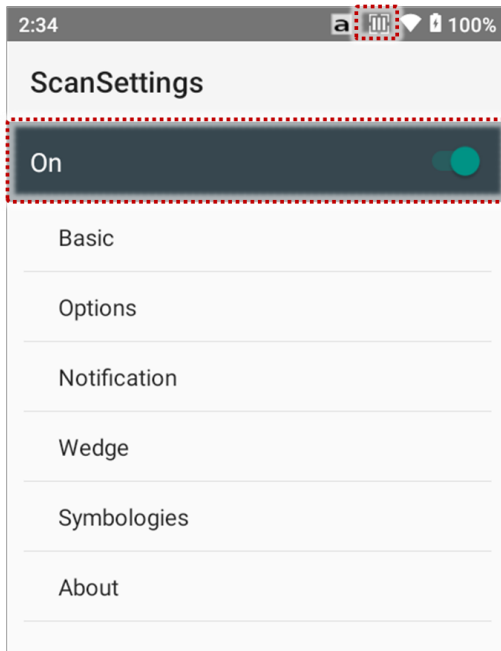
When the scanner is turned on, scanner setting menus will be displayed. **ScanSettings** consists of

- Basic
- Options
- Notification
- Wedge
- Symbologies
- About

Basic

Control the scanning options and wedge mode options.

1. Scanning

- Change the scanner's trigger timeout and set scan mode (single / auto / continuous scan).
- Enable or disable the TouchScan, which is a software scanner button. Place a scan icon in any position and tap the icon to read a barcode.

Figure 58 ScanSettings - Basic

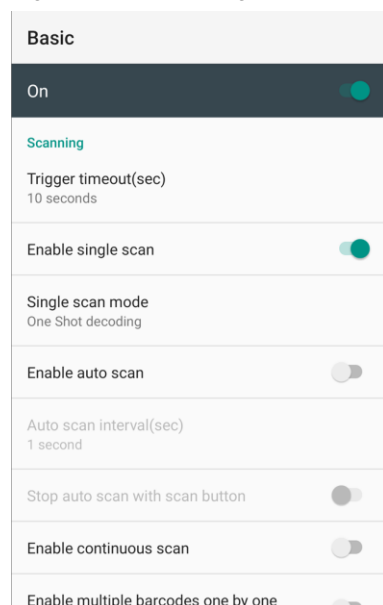
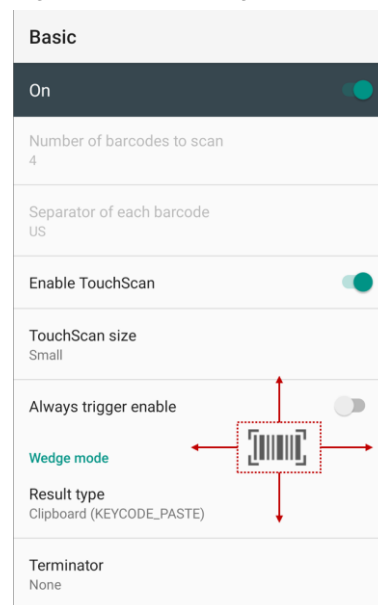

Figure 59 ScanSettings - TouchScan



Scanner

2. Wedge mode

- Change the result type of decoded data among the below list.
 - User Message
 - Keyboard Event (Multiple)
 - Keyboard Event (Single)
 - Clipboard (KEYCODE_PASTE)
 - Clipboard (Ctrl + V)
 - Intent Broadcast
 - Custom Intent
- Set Terminator as,
 - None
 - Space
 - Tab
 - LF
 - Tap & LF

Options

- Enable / Disable the center window, Aimer, Illumination.

Figure 60 ScanSettings - Options

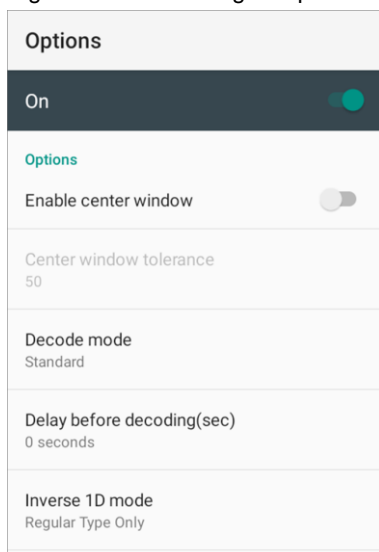

Scanner

Notification

Control the beep sound, LED and vibration option when scanning the barcode.

Figure 61 ScanSettings - Notification

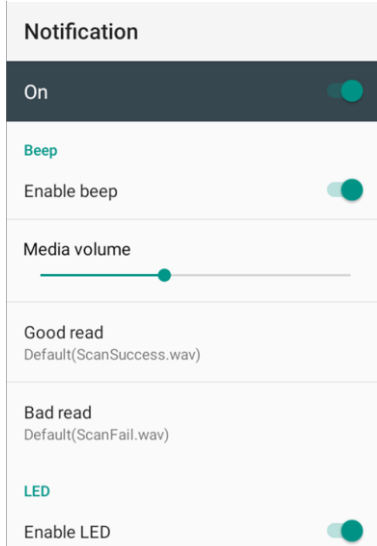

Scanner

Wedge

Set below items in Wedge settings

- Barcode ID
- AIM ID
- Group separator
- Prefix
- Suffix
- Character set
- Extended Wedge

Figure 62 ScanSettings - Wedge

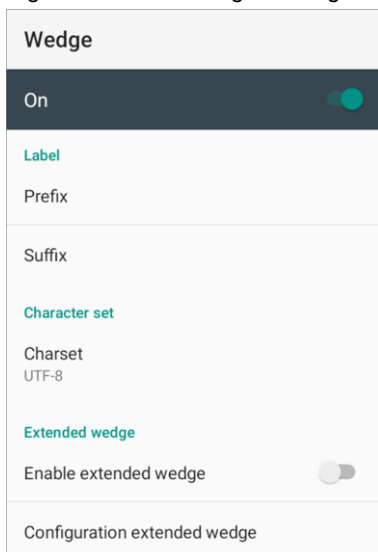

Scanner

Extended wedge

PM86 supports Extended wedge that allows to edit the decoded data. Tap **Enable extended wedge** toggle switch and then set a rule in **Configuration extended wedge**.

Figure 63 ScanSettings - Extended wedge

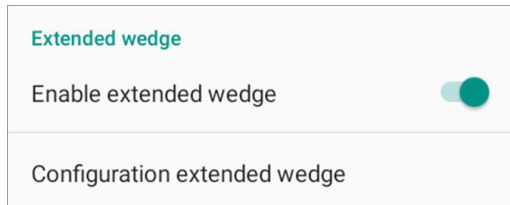

For example, make a rule that add a string “*Point Mobile*” at the start of decoded data whenever decoding CODE128.

1. Tap **Style** (1) and select **Condition** (2).

Figure 64 Extended wedge example_1

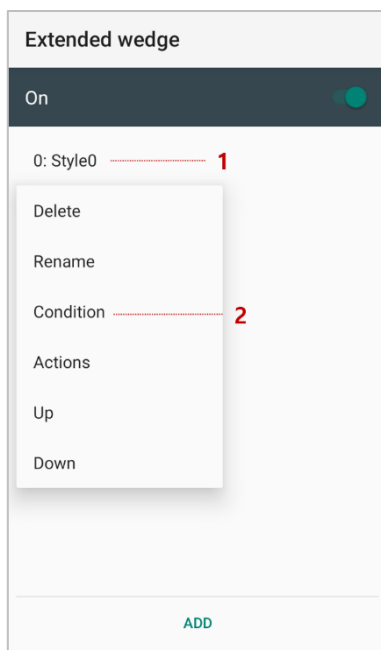

Scanner

2. Tap **Symbologies** and select **CODE128** among the symbologies.

Figure 65 Extended wedge example_2

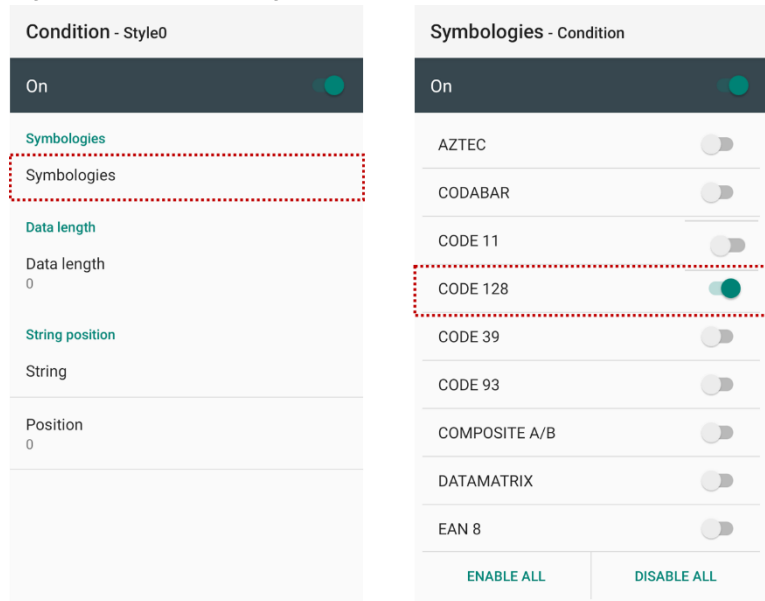

3. Tap **Style (1)** and select **Actions (2)**.

Figure 66 Extended wedge example_3

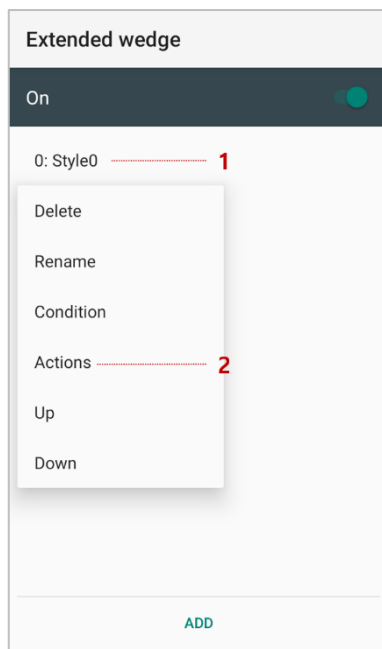

Scanner

4. Tap **ADD** and select **Move to start** to point the start of the decoded data.

Figure 67 Extended wedge example_4

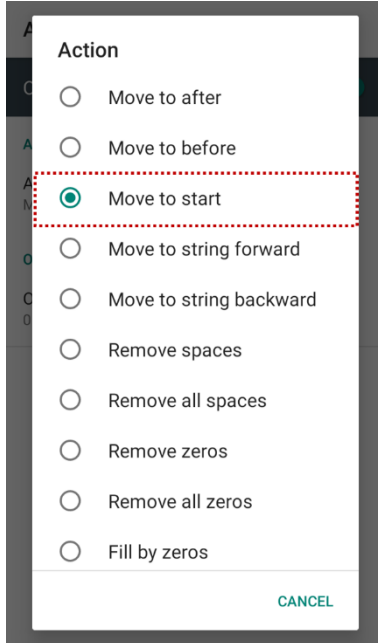

5. Add another action of which action type is Send string. Set value as "*Point Mobile*".

Figure 68 Extended wedge example_5

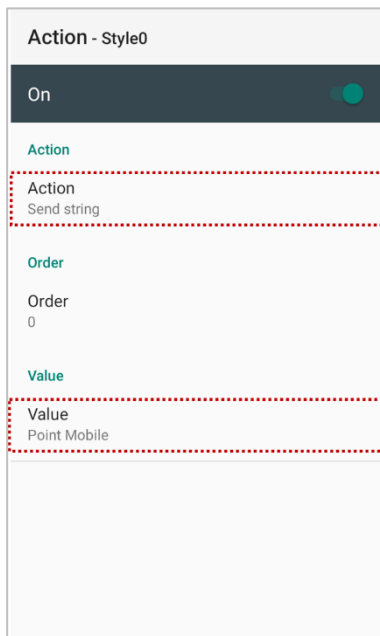

Scanner

6. "Point Mobile" string will be added to decoded CODE128 data.

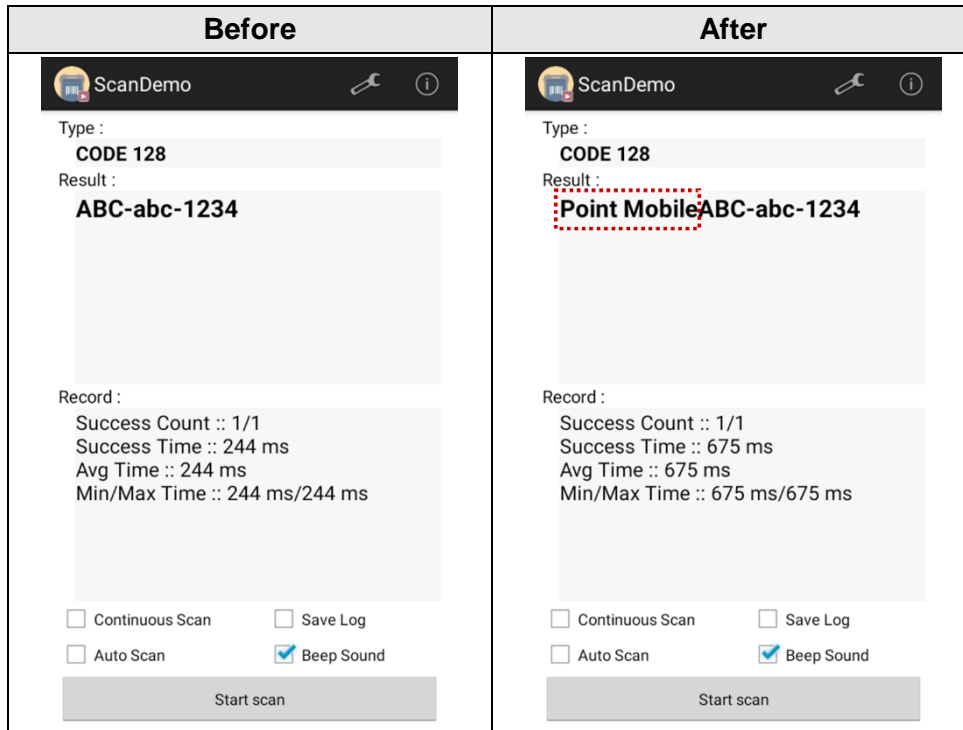

Scanner

Symbologies

Enable or disable the specific symbology or set detail options. By tapping each symbology name to access detail options.

Figure 69 ScanSettings - Symbologies

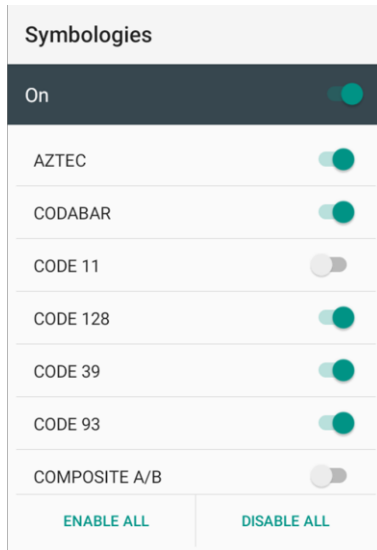

About

Find the scanner information or restore the scanner settings to default.

Figure 70 ScanSettings - About

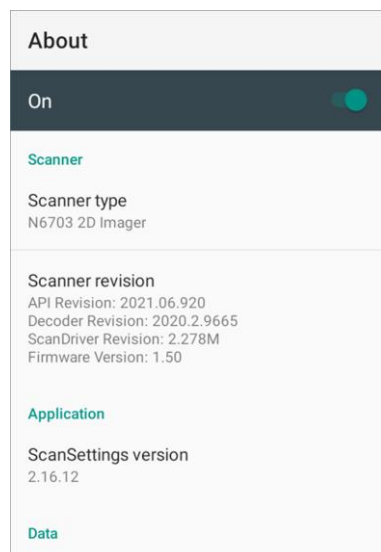

Scanner

Scan a Barcode

Point the scanner at the barcode and press the scan button on the device or gun handle. If another button is set as scan trigger using Program buttons (Refer to [Use the Buttons – Program buttons](#)), it can trigger the scan action, too.



Note:

If you set the single scan mode as Press decoding or Release decoding, it may require another button pressing mechanism to trigger scanning. Refer to [Single Scan Mode article](#) for more detail.

Center the cross-hair laser aimer over the barcode. The barcode must be within the square made by the edge of the aimer. You can tilt the aimer slightly for a comfortable angle to scan.

Figure 71 Aiming barcode



Scanner

ScanDemo

Using ScanDemo app, demonstrate scanning feature.



1. Execute **EmKit**  > **ScanDemo** .
2. Scan a barcode by pressing the scan button on the device or tapping **Start scan** button on the screen.
3. Find scan result

Figure 72 ScanDemo



Wireless

Mobile Network

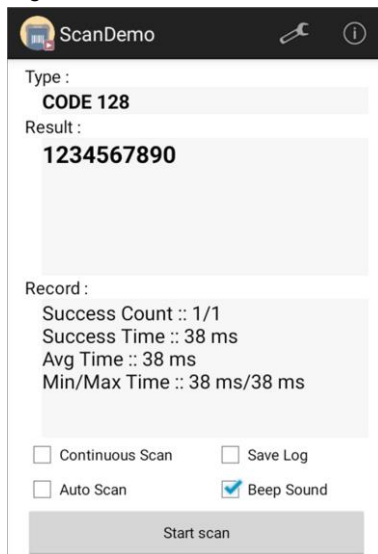

Note: Mobile network is supported on PM86 LTE SKU (SKU 3 ~ 6) only. Check if your PM86 is LTE SKU.

To connect mobile network, SIM card is required. Insert SIM card into PM86 first referring [Install SD & SIM & SAM cards](#).

After inserting the SIM card, reboot the device. When network is connected, a network icon will be appeared on the status bar.

Figure 73 Mobile network icon

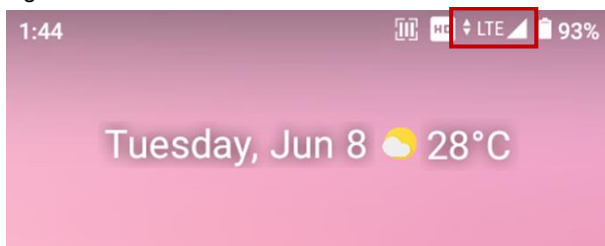

Find network information and adjust the network settings in **Settings** > **Network & internet** . This setting menu can also be accessed by long-press the Mobile data icon in Quick setting panel.

Figure 74 Mobile network setting

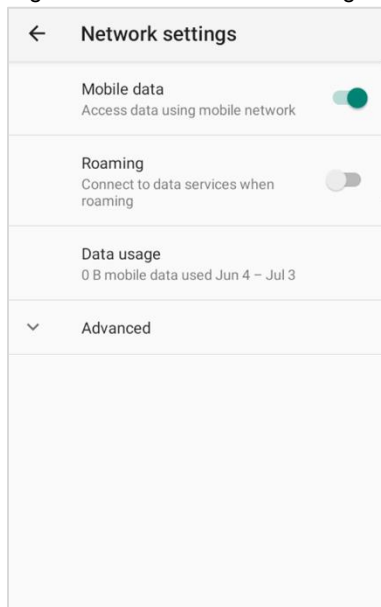
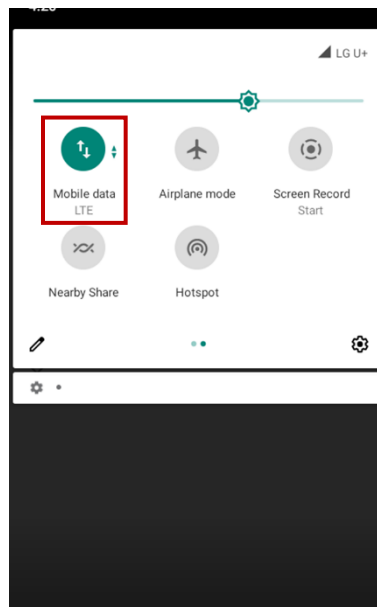

Figure 75 Quick setting panel - mobile network



Wireless

Wi-Fi

To turn on and connect a Wi-Fi,



1. Go to **Settings**  > **Network & internet**  > **Wi-Fi**.
2. Tap toggle button to enable Wi-Fi.
3. Device searches for nearby Wi-Fi signals and lists them in order of signal strength.
4. Select a Wi-Fi SSID to connect.
5. The message **Connected** under the SSID means the device complete to connect to the Wi-Fi.

Figure 76 Wi-Fi connected



Note: There are Open Wi-Fi network and Secured Wi-Fi network. You can tell those apart by lock icon (🔒) in the nearby Wi-Fi list.

To connect the secured Wi-Fi network, you need to enter the password.

Figure 78 Open Wi-Fi Network

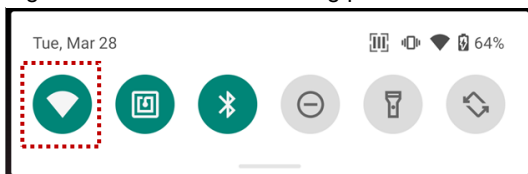

Figure 77 Secured Wi-Fi Network



If there is a saved Wi-Fi network, simply turn on the Wi-Fi through the Quick setting panel. The saved network will be connected automatically.

Figure 79 Wi-Fi in Quick setting panel



Wireless

Bluetooth

Turn on / off

Bluetooth is turned off as default. There are two ways to turn on the Bluetooth,

- Open quick setting panel and enable Bluetooth 

Figure 80 Bluetooth in Quick setting panel



- Go to **Settings**  > **Connected devices**  > **Pair new device**

Pair and Connect

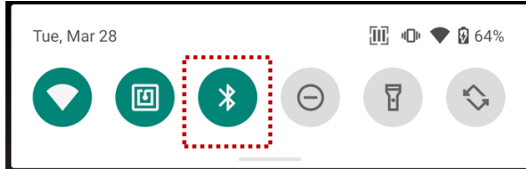
To connect with a new device,



1. Go to **Settings**  > **Connected devices** .
2. Tap **Pair new device**.
(Bluetooth will be turned on automatically)
3. Select the device you want to pair among **Available devices** list.

Figure 81 Bluetooth available devices



4. Follow instructions on the screen (Pairing code or pairing confirmation dialog) and tap **PAIR**.

Wireless

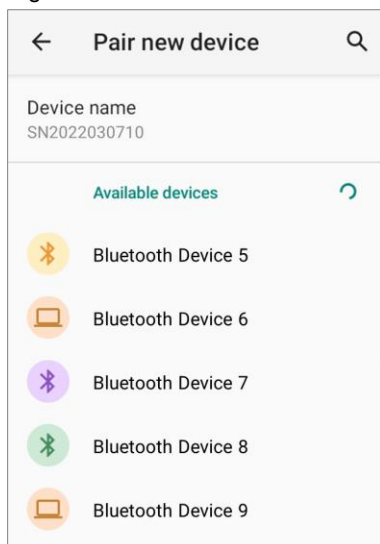
5. When the connection is succeeded, the connected device name is listed on the top of the screen.

Figure 82 Bluetooth currently connected

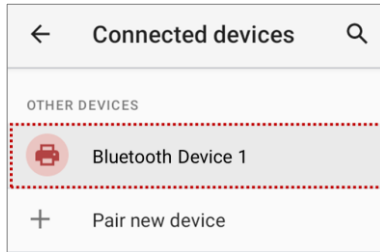

To connect a device previously connected, select the device name from the **PREVIOUSLY CONNECTED DEVICES** list.

Figure 83 Previously connected devices

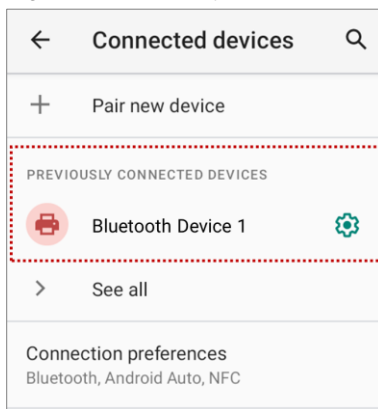

Unpair and Disconnect

To unpair the device, select the name of the device you want to unpair from **CURRENTLY CONNECTED** list and tap **FORGET** .

Or tap **DISCONNECT**  to disconnect only and not unpair.

Figure 84 Forget device



Wireless

Change the Bluetooth device details

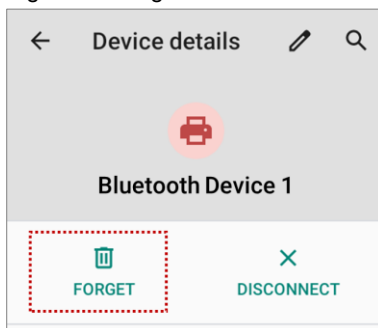
Select a device name from the top list or tap  icon next to the device name from **PREVIOUSLY CONNECTED DEVICES** list.

Figure 85 Bluetooth device detail

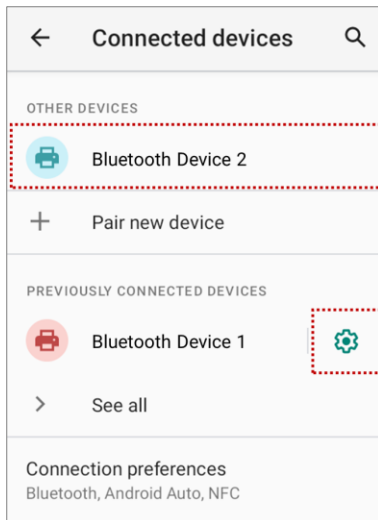

If no devices are listed under the **PREVIOUSLY CONNECTED DEVICES**, tap **See all**.

- To change the device's name, tap  on the top of the screen
- Turn other settings on or off (Available on some devices)

BLE Beacon

The PM86 integrates the BLE beacon that can transmit BLE signal up to **20 days** while it is powered off and without the main battery.

This transmission duration is based on the default BLE beacon settings and it can be increased or reduced by adjusting transmit power and interval.

Wireless

NFC

PM86's NFC antenna is located on the rear-top side of the device. Bring the NFC tag close to the antenna location as Figure 87.

NFC feature is enabled by default. But if NFC does not work, make sure the NFC  is enabled from the Quick setting panel.

Figure 86 PM86 NFC tapping area

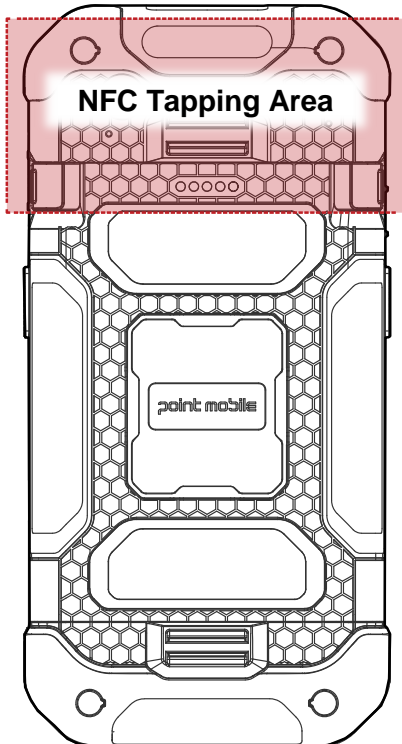

Figure 87 PM86 NFC tapping



System Maintenance

System Information

There are two ways for checking system information, on settings and on EmKit.

On Settings

Go to **Settings**  > **About phone** . Following information can be found.

- Device name
- Phone number
- Emergency information
- Legal information & Certificates
- Model & SIM status
- Hostname
- IMEI
- Android version
- IP address
- Wi-Fi MAC address
- Bluetooth address
- Build number

On EmKit

Go to **EmKit**  > **System Information** . Following information can be found.

- Processor information
- Version information (Android version, OS image version, SDK version, etc.)
- Manufacturer information (Serial number, Part number, etc.)
- Device information (Scanner, Audio, Display, etc.)
- Battery information (Battery charging status, etc.)
- App version information (Version of EmKit apps)

System Maintenance

Check Device Health

EmHealthReport is a solution that provides the device's battery and eMMC health.

Monitor the battery and eMMC status to foresight their lifetime or find the cause when there is a battery problem such as cannot charge the device or rapid battery discharge.



To use, open **EmKit**  and launch **EmHealthReport** . You can see the simple device health information on the main screen. To find detailed information, tap each blue arrow on the right side of the screen.

Figure 88 EmHealthReport



- **Battery Health**
 - Battery Level
 - Battery Age
 - Battery Voltage
 - Battery Temperature
 - System Temperature
 - Battery Manufacture Date
 - Battery Serial Number
 - Smart Charging Mode
- **eMMC Health**
 - Pre-EOL Information
 - Device life time estimation type A
 - Device life time estimation type B

System Maintenance

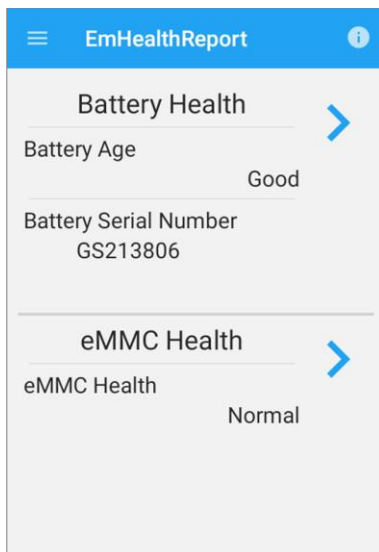
OS Update

Periodic update improves the performance of the device. Point Mobile provides up-to-date OS version via Service Portal and FOTA. Update the device via storage, OTG port, and FOTA server. Depending on the workspace environment, choose more suitable method.



Notice: Please backup your data before starting the update process.

OS update via storage

To update the OS using storage,



1. Download an OS image file into the root folder of microSD card or device internal storage
2. (In case of using SD card) Insert SD card to the device and then turn the device on
3. Go to **Settings**  > **System**  > **Advanced** > **System Update**
4. Check if the OS image file shows up under **AVAILABLE VERSIONS**

Figure 89 OS update via storage



5. Tap **UPDATE** to start the update process



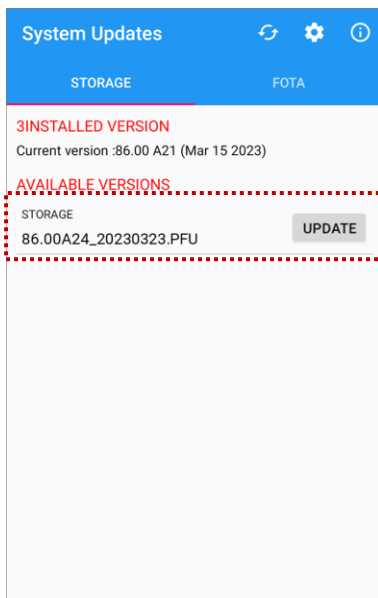

Note: If the OS image file doesn't show up in **AVAILABLE VERSIONS**, check the file is placed in the root folder of storage. System only can recognize the file in the root folder.

System Maintenance

OS update via OTG port

PM86 supports the USB OTG feature.

1. Prepare a formatted USB flash drive for OS update
2. Copy an OS image file to the root folder of the flash drive
3. Connect the flash driver to the PM86
4. Go to **Settings**  > **System**  > **Advanced** > **System Update**
5. Check if the OS image file shows up under **AVAILABLE VERSIONS**
6. Tap **UPDATE** to start the update process

OS update via FOTA

If PM86 can connect to a network, use the FOTA server for the update.



1. Connect the device with a network
2. Go to **Settings**  > **System**  > **Advanced** > **System Update**
3. Tap **FOTA** tab or Swipe left to move to **FOTA** tab
4. If there is an OS version newer than device's one, the server shows the new OS information

Figure 90 OS update via FOTA



System Maintenance

5. Tap **Download**
6. Tap **OK** on the **OS Update** dialog to start to download the OS image file
7. To complete the update, rebooting is required.

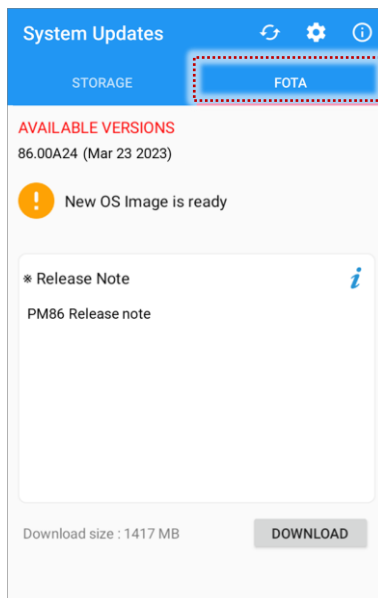
Tap **OK** on the **Restart required** dialog to restart the device

i **Note:** Basically, OS update via FOTA works over Wi-Fi or Ethernet only. To enable the OS update over Mobile Network too, uncheck the setting value in FOTA Settings. Downloading over the Mobile network may result in additional charges.

Figure 91 FOTA Settings

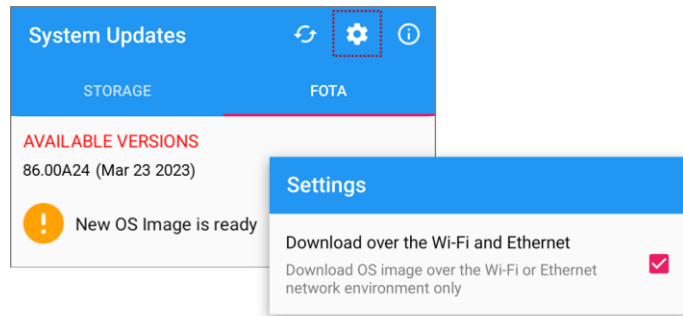

System Maintenance

Factory Data Reset

When PM86 work abnormal or there is a need to reset the device, follow the steps below to perform a factory data reset.



Caution: Factory data reset will erase all personalized settings and data saved in the device, such as Google account, apps, user data, etc. And factory data reset cannot undo.

Factory data reset via Settings app

If the device can be turned on and access **Settings**,



1. Navigate to **Settings**  > **System**  > **Advanced** > **Reset options**
2. Tap **Erase all data (factory reset)**
3. After being aware that factory reset will erase all data from the internal storage, tap **Erase all data**

Figure 92 Factory data reset



4. Tap **Erase all data** again to start the factory reset process

System Maintenance

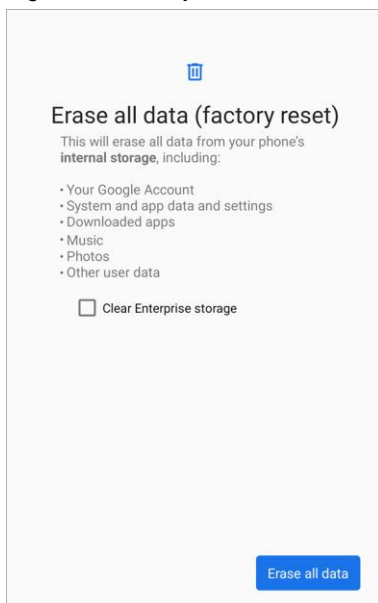
Factory data reset via recovery mode

If device works abnormal so does not turn on, try to perform factory data reset through Android recovery mode.

1. Press and hold **power button + Volume Up** buttons simultaneously when PM86 is turned off.

Figure 93 Key combination for recovery mode

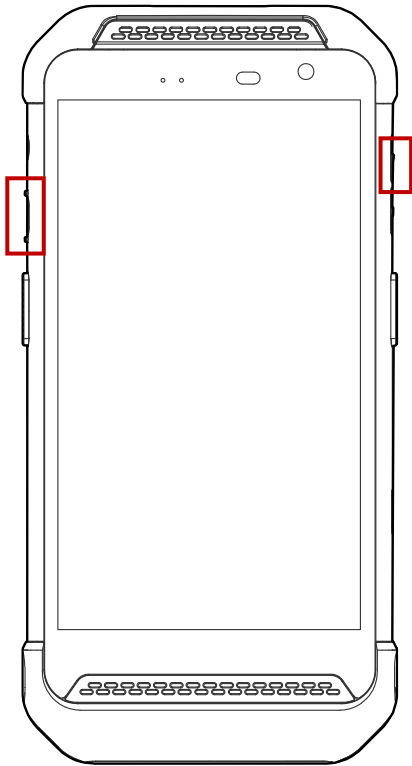

2. After short vibration, release the power button
3. Using the buttons below, select **Wipe data/factory reset**
 - **Move up/down** – Volume up/down
 - **Select the menu** – Power button
4. Select **Factory data reset**.
5. After wiping the data, select **Reboot system now**

Accessories

PM86 supports below accessories. All accessories except hand strap are sold separately.

Category	Accessory Name	Usage
Hand strap	Hand strap	Carries PM86 easily
Protection case	Rugged boot	Protects PM86 from drop or damage
Gun handle	Gun handle	Provides an ergonomic trigger button
Charging cradle	SSC (Single Slot Cradle) / SEC (Single Slot Ethernet Cradle)	Charges one PM86 and one PM86 battery Provide USB type C port or ethernet port
	PM85 2SC (2 Slot Cradle)	Charges two units of PM86 (Compatible with PM85)
	4SBC (4 Slot Battery Cradle)	Charges up to four pieces of PM86's batteries

Hand Strap

Hand strap is included in PM86 standard package. The hand strap helps users to hold the device easier.

Figure 94 PM86 Hand strap

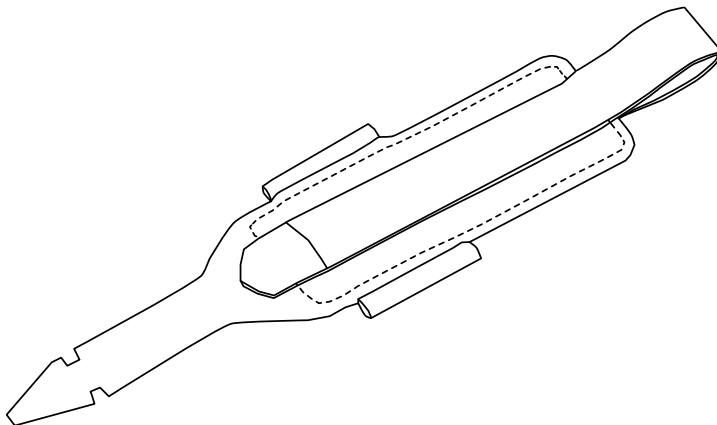

Accessories

Mount hand strap

1. Thread the arrow-like side of the strap through the hand strap hole.

Figure 95 Mount hand strap_1

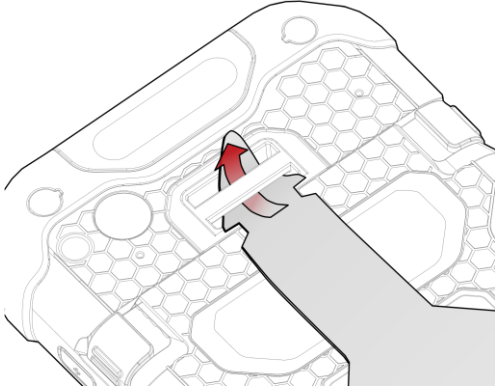

2. Insert the arrowhead into the small hole of the hand strap and pass it through the neck.

Figure 96 Mount hand strap_2

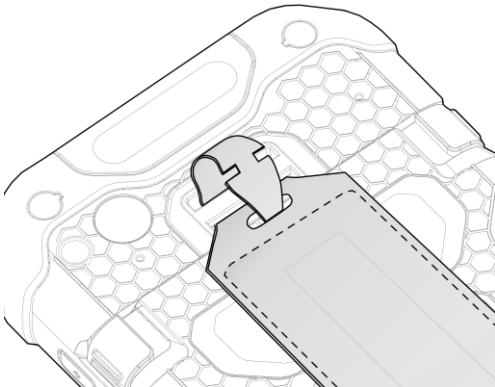

3. Thread the opposite side of the strap through another hand strap hole.

Figure 97 Mount hand strap_3

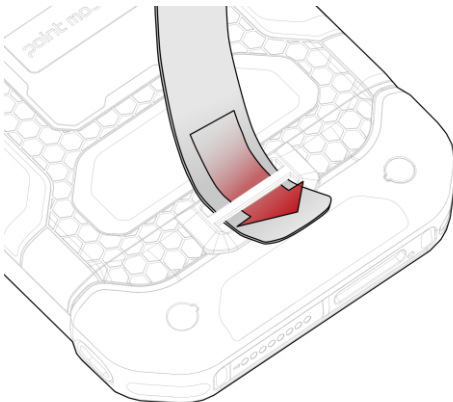

Accessories

4. Pull the strap and attach the Velcro at the desired length.

Figure 98 Mount hand strap_4

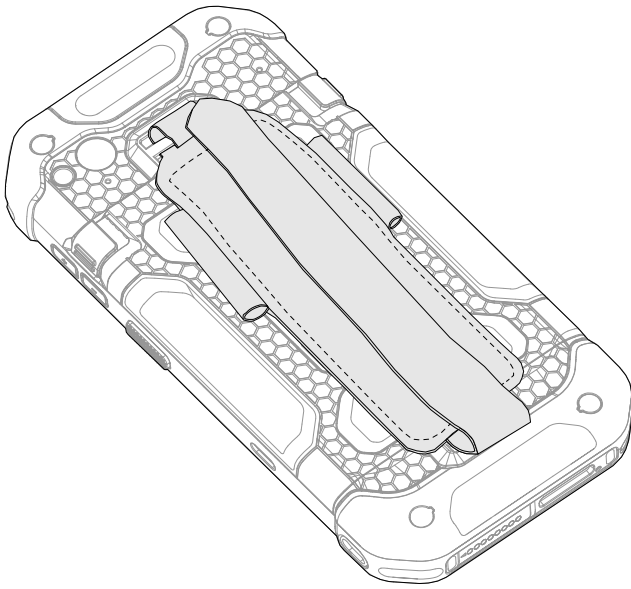

Accessories

Rugged Boot

To protect the PM86 from damage such as drop or tumble, attach a rugged boot to PM86.

Attach rugged boot

1. Place the left or right side of the PM86 to the bottom part of the rugged boot first. And then, push the other side to engage the part.

Figure 99 Attaching rugged boot_1

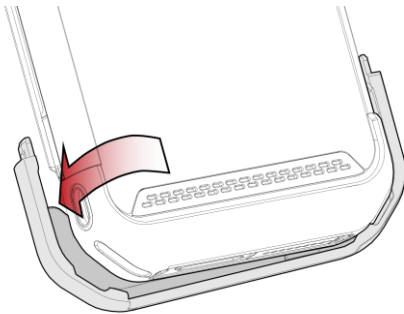

2. Insert the top part of the rugged boot from top to bottom.

Figure 100 Attaching rugged boot_2

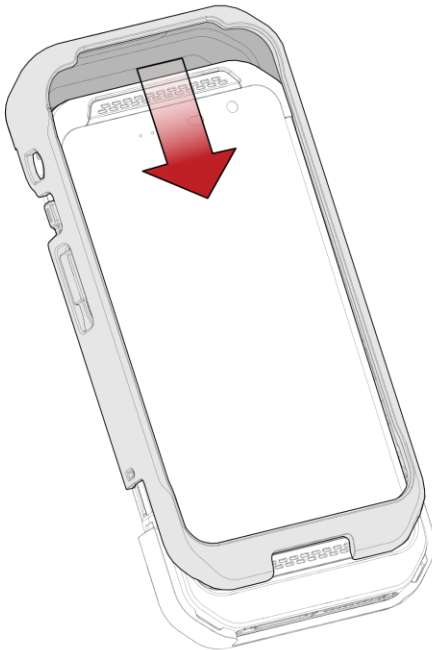

Accessories

3. Make sure that the parts are engaged firmly.

Figure 101 Attaching rugged boot_3



Accessories

Detach rugged boot

1. Widen the both side of the top part of the rugged boot, and pull the PM86 out.

Figure 102 Detaching rugged boot_1

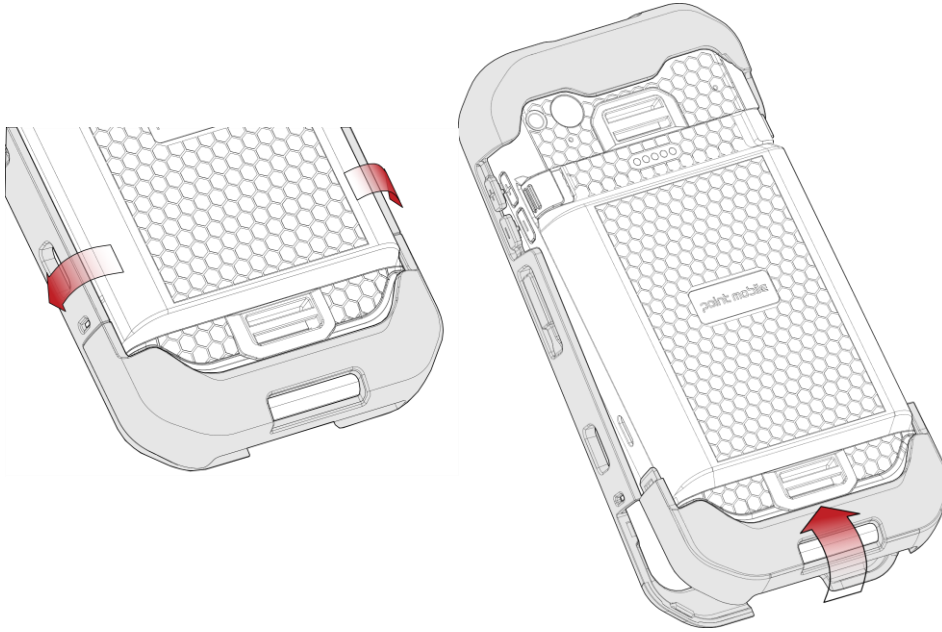

2. Pull the one side of the bottom part to remove the rugged boot completely.

Figure 103 Detaching rugged boot_2

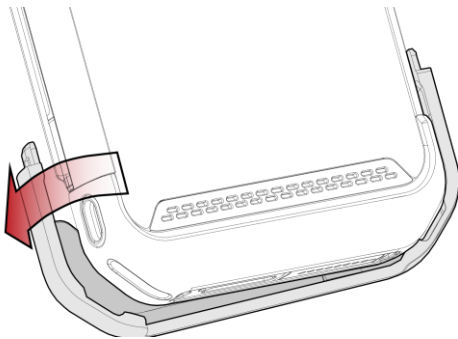

Accessories

Gun Handle

Attach a gun handle to PM86 and use additional programmable button. The button is used for triggering scanner usually.

Figure 104 PM86 Gun handle

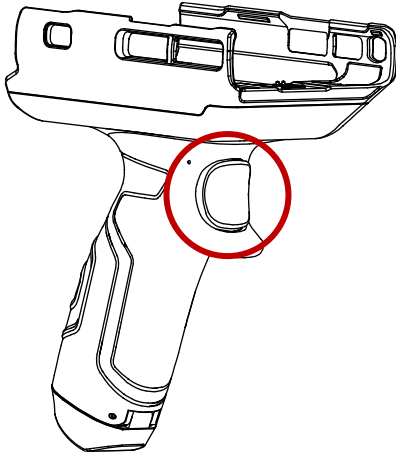

Attach gun handle

1. Align the gun handle to match the button holes to the PM86 buttons.
2. Place the left or right side of the PM86 to the gun handle first.
3. Push the other side to engage the gun handle.

Figure 105 Attaching gun handle

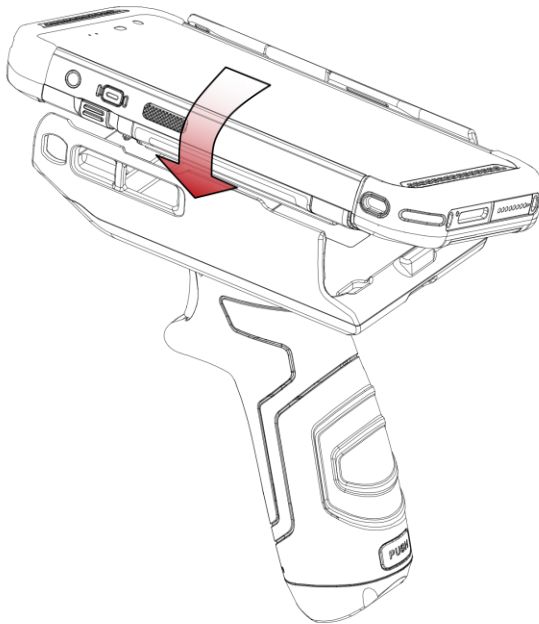

Accessories

Attach gun handle hand strap

A hand strap is enclosed in the gun handle package. Attach the strap and carry the device more comfortably.

Figure 106 Gun handle - hand strap

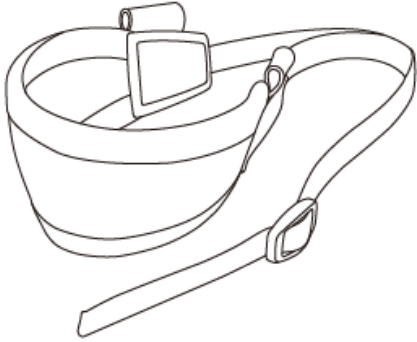

1. Thread the strap through the hole on the bottom side of the retention fixture.

Figure 107 Gun handle - Attach hand strap_1

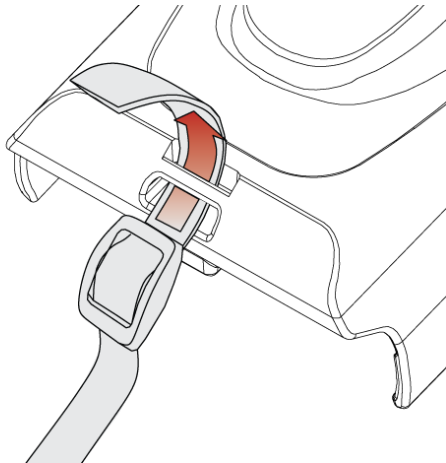

Accessories

2. Slide the strap through the buckle at the appropriate length.

Figure 108 Gun handle - Attach hand strap_2

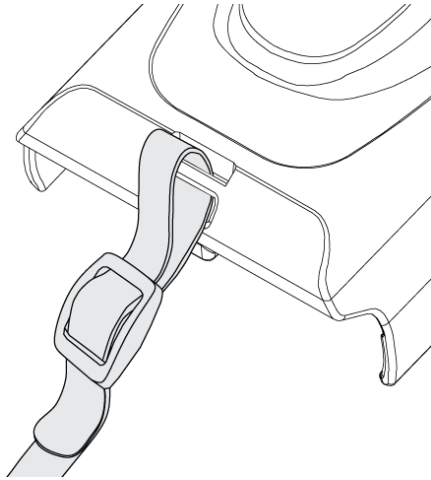

Accessories

Charging Cradle

Single Slot Cradle (SSC / SEC)

SSC and SEC have one device slot and one battery slot so that it can charge a PM86 (available in sled type accessory mounted) and a battery at the same time.

In addition to the charging function, the cradle also provides a USB Type C port (SSC) or ethernet port.

You can charge the following device combination using the device slot.

- With Cradle cup
 - PM86 only
- Without Cradle cup
 - PM86 with gun handle mounted
 - PM86 with RF88 (RFID reader) mounted
 - PM86 with rugged boot

To charge the device with sled type accessory mounted or with a rugged boot, you must remove the Cradle cup from the cradle.

For more detail, see PM86 SSC / SEC Quick start guide.

Figure 109 PM86 SSC / SEC

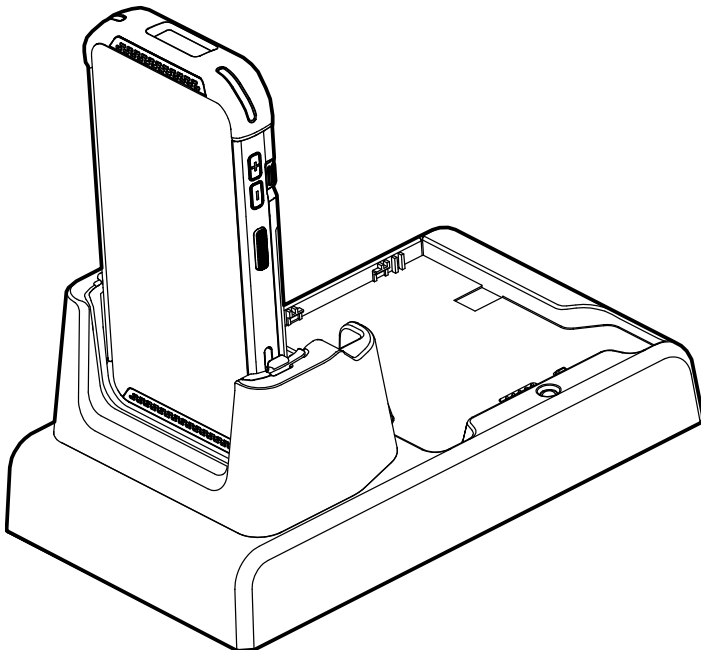

Accessories

2SC (2 Slot Cradle)

2SC has 2 device slots so it can charge up to two units of PM86 simultaneously. 2SC is compatible with PM85.

You cannot charge PM86 with any accessories mounted.

Figure 110 PM8X 2SC

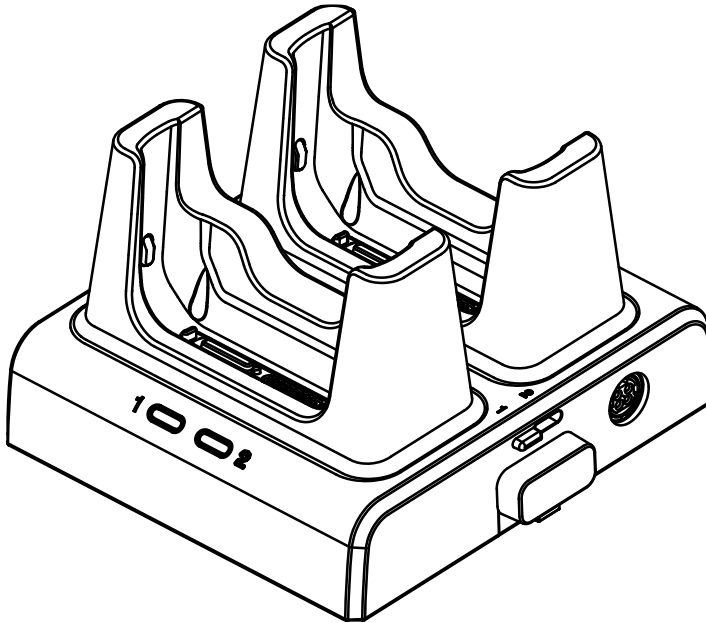

It is possible to connect up to 3 pieces of 2SC to make a share cradle for more charging slots (2SC ~ 6SC).

For more detail, see PM85 2SC Quick start guide.

Accessories

4SBC (4 Slot Battery Cradle)

4SBC has 4 battery slots so it can charge up to four pieces of PM86's battery simultaneously.

For more detail, see PM86 4SBC Quick start guide.

Figure 111 PM86 4SBC

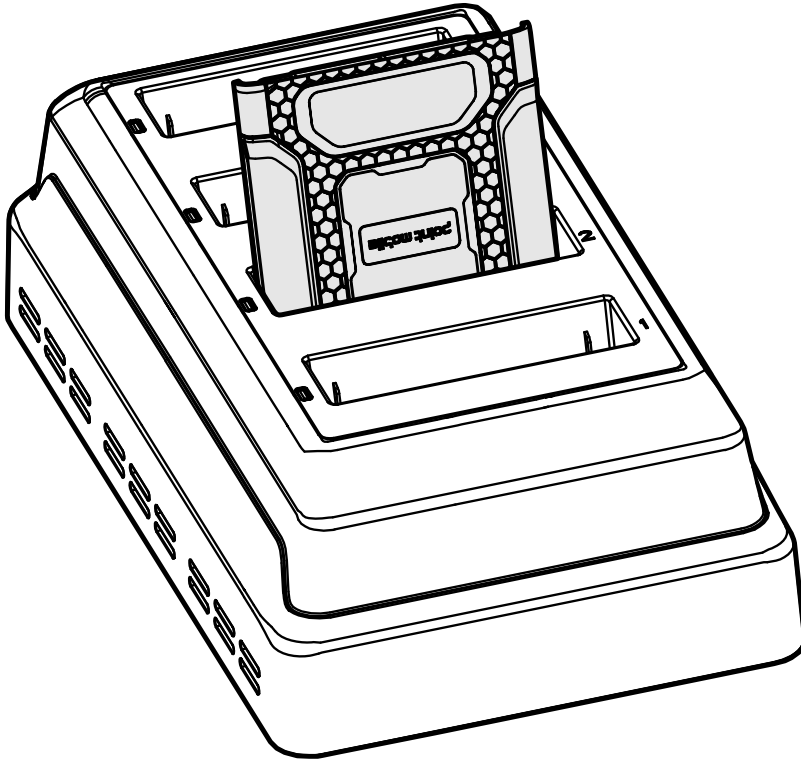

Safety Information

Battery Safety Information

Follow the battery safety guidelines for safe usage, storage, and disposal of Li-ion batteries. Improper battery use may result in a fire, explosion, or other critical hazards.

Battery Safety Guidelines

- Use only Point Mobile approved batteries and charging accessories. Other batteries and chargers may damage the device or result in a fire, leakage, or other hazards.
- Do not expose the battery to excessive heat or cold.
- Do not use or store the battery in or near areas that might get very hot, such as in a parked vehicle, near a heat duct or close to other heat sources.
- Do not allow objects that may cause a short circuit, such as metal objects, corrosive substances, or liquids like water, to contact the battery.
- Do not disassemble, crush, bend, shred, press, or other actions that may damage or deform the battery.
- Do not use or replace the battery on the go or from a high location. Dropping may result in an explosion or fire.
- Do not put any labels, stickers, tags, etc. on the device or battery. Performance of the device or battery, such as sealing, drop, or tumble, could be affected.
- Close supervision is necessary when used near children to avoid the risk of injury.
- If battery leakage is observed, avoid any contact with the skin or eyes and properly dispose of the battery. If contact has been made, wash the affected area with water for 15 minutes and seek medical advice.
- If you notice any type of damage to the battery, such as swelling, dents, and leaks, stop using it immediately and contact Point Mobile.

Battery Charging Guidelines

- Charge the battery in a clean, cool, dry, and ventilated environment.
- Separate the charger from the battery as soon as possible when the battery is fully charged.
- Battery performance can degrade due to the stress of daily charging and discharging. Batteries typically need to be replaced after 300 to 500 charging cycles (full charge-discharge cycles) or when the battery capacity has been reduced to 70 ~ 80% of its original capacity. The actual number of charging cycles varies based on usage patterns, temperature, age, and other factors.

Safety Information

Battery Storage / Disposal Guidelines

- Store the batteries in a clean, dry and ventilated environment within ambient temperature ranges of $20\pm 5^{\circ}\text{C}$.
- For safety regulations, batteries are charged to below 20~30% of full capacity during production.
- When not using batteries for a long period, charge the battery for 30 minutes to 1 hour at least once every 6 months to prevent full discharge and keep the performance.
- Batteries should be stored separately when storing for long periods. Disconnect from any device, charger, or cradle.
- Dispose of used batteries promptly according to local disposal regulations.
- Do not dispose of the battery in fire. It may cause explosion.



Notice: *The battery is consumable. Point Mobile provides a warranty for the battery for 12 months after purchase.*

If you suspect the battery swelling, change the battery immediately and contact Point Mobile.



Point Mobile. Co., Ltd.

Offline

Tel: +82-2-3397-7870~1

ARS: +82-1800-3010

Fax: +82-2-3397-7872

Address: 9F Kabul Great Valley, 32, Digital-ro 9-gil,
Geumcheon-gu, Seoul, Korea 08512

Online

Website: <https://www.pointmobile.com>

E-mail: pm_ta@pointmobile.com