



# HR33 MARLIN BT

Handheld Scanners

# Disclaimer

© 2023 Newland Europe BV. All rights reserved.

Please read the manual carefully before using the product and operate it according to the manual. It is advised that you keep this manual for future reference.

Do not disassemble the device or remove the seal label from the device; doing so will void the product warranty provided by Newland Europe BV.

All pictures in this manual are for reference only, and the actual product may differ.

Regarding product modification and update, Newland Europe BV reserves the right to make changes to any software or hardware to improve reliability, function, or design at any time without notice. The information contained herein is subject to change without prior notice.

The products depicted in this manual may include software copyrighted by Newland Europe BV or a third party. The user, corporation or individual shall not duplicate, in whole or in part, distribute, modify, decompile, disassemble, decode, reverse engineer, rent, transfer, or sublicense such software without prior written consent from the copyright holders.

This manual is copyrighted. No part of this publication may be reproduced, distributed, or used in any form without Newland Europe BV's written permission.

**Risk Warning Regarding Unauthorized System Updates:**

You should use the Newland-provided tool to update this product's system. Modifying system files by installing a third-party ROM system or using any cracking method may result in product malfunction or data loss and void your warranty.

Newland Europe BV reserves the right to make a final interpretation of the statement above.

**Newland Europe BV**

Rolweg 25, 4104 AV, Culemborg,  
The Netherlands  
[www.newland-id.com](http://www.newland-id.com)

Newland Europe BV is a subsidiary of Newland Digital Technology Co., Ltd. Our general conditions of Purchase, Sale and Delivery are filed with the Record Office of the Chamber of Commerce of Utrecht, The Netherlands.

K.v.K. H.R. Utrecht / Chamber of  
Commerce Utrecht:  
Reg. nr. 17109876

# Revision History

Version	Description	Date
V1.0.0	Initial release.	July 15 <sup>th</sup> , 2024

# Table of Contents

<b>Revision History</b> .....	<b>3</b>
<b>Preface</b> .....	<b>1</b>
Introduction.....	1
Chapter Description.....	1
Explanation of Icons.....	2
<b>Chapter 1 Getting Started</b> .....	<b>3</b>
Introduction.....	3
Features of the HR3300-BT.....	3
Unpacking.....	3
The Scanner.....	4
Dimensions of the Scanner (unit: mm).....	5
HCD20 Cradle.....	6
Connecting the Cradle to a Host.....	7
Using USB Cable.....	7
Pairing the Scanner to a Cradle.....	8
Power On, Power Off, Reboot.....	8
<b>Chapter 2 Easyset</b> .....	<b>9</b>
<b>Chapter 3 System Setting</b> .....	<b>10</b>
Introduction.....	10
Barcode Programming.....	10
Command Programming.....	10
EasySet Programming.....	10
Programming Barcode/ Programming Command/Function.....	11
Use of Programming Command.....	12
Use of Programming Barcodes.....	12
Illumination.....	13
Aiming.....	13
Good Read LED.....	14
Good Read LED Duration.....	14
Power On Beep.....	15
Good Read Beep.....	15
Good Read Beep Duration.....	16
Good Read Beep Frequency.....	17



Good Read Beep Volume .....	18
Remind Beep Volume .....	19
Scan Mode .....	20
Decode Session Timeout .....	21
Image Stabilization Timeout (Sense Mode).....	22
Reread Timeout.....	23
Image Decoding Timeout .....	24
Image Decoding Preference .....	25
Sensitivity (Sense Mode).....	26
Scanning Preference .....	27
BEL Character Beep.....	28
Surround GS1 Application Identifiers (AIs) with Parentheses .....	29
Output GS1 Application Identifiers (AIs).....	30
GS1 Composite .....	31
GS1 Databar(RSS).....	31
GS1 QR.....	31
GS1 Data Matrix.....	32
Transmit GS1 Check Character.....	33
Read Barcode On/Off .....	34
Smart Stand Mode.....	34
Decode Area.....	35
Image Flipping .....	39
Bad Read Message .....	40
Set Bad Read Message .....	40
Power Off.....	41
Default Settings .....	41
Factory Defaults .....	41
Custom Defaults.....	41
Query Scanner Information .....	42
Query Product Name.....	42
Query Firmware Version.....	42
Query Decoder Version .....	42
Query Data Formatter Version .....	43
Query Hardware Version.....	43
Query Serial Number.....	43
Query OEM Serial Number.....	43
<b>Chapter 4 Wireless Communication.....</b>	<b>44</b>

Bluetooth HID .....	44
Bluetooth BLE.....	44
Bluetooth Dongle KBW.....	44
USB Country Keyboard Types .....	45
Beep on Unknown Character .....	49
Emulate ALT+Keypad .....	50
Function Key Mapping.....	54
ASCII Function Key Mapping Table .....	55
ASCII Function Key Mapping Table (Continued) .....	56
Inter-Keystroke Delay.....	57
Caps Lock.....	57
Convert Case.....	58
Emulate Numeric Keypad.....	59
Fast Mode.....	62
Polling Rate .....	63
Bluetooth Dongle CDC .....	65
Bluetooth Dongle HID POS (POS HID Barcode Scanner) .....	66
Introduction.....	66
Access the Scanner with Your Program.....	66
Acquire Scanned Data .....	67
Send Command to the Scanner .....	67
VID/PID.....	68
Default Setting of Wireless Communication .....	69
Clear Pairing Information of Scanner .....	69
Operating Modes .....	70
Batch Mode .....	71
Batch Mode Options .....	71
Prevent Same Barcode Storage.....	72
Batch Mode Transmit Delay .....	73
End of Transmission Message for Batch Mode.....	74
Transmit Stored Data .....	75
Auto Clear Stored Data after Transmission.....	75
Query/Clear Stored Data in Flash .....	75
Auto Power-Off Timeout .....	76
Set Scanner Name .....	77
Set Date and Time.....	78
Query Current Date and Time .....	78

Query Battery Status .....	79
Time Stamp .....	79
Set Time Stamp Format .....	80
<b>Chapter 5 Symbologies .....</b>	<b>81</b>
Introduction .....	81
Global Settings .....	81
Enable/Disable All Symbologies.....	81
Enable/Disable 1D Symbologies .....	81
Enable/Disable 2D Symbologies .....	82
Enable/Disable Postal Symbologies.....	82
Code 128 .....	83
Restore Factory Defaults.....	83
Enable/Disable Code 128.....	83
Set Length Range for Code 128.....	84
EAN-8 .....	85
Restore Factory Defaults.....	85
Enable/Disable EAN-8.....	85
Transmit Check Character.....	85
2-Digit Add-On Code .....	86
5-Digit Add-On Code .....	87
Add-On Code Required .....	88
Convert EAN-8 to EAN-13.....	88
EAN-13 .....	89
Restore Factory Defaults.....	89
Enable/Disable EAN-13 .....	89
Transmit Check Character.....	90
2-Digit Add-On Code .....	90
5-Digit Add-On Code .....	91
Add-On Code Required .....	91
EAN-13 Beginning with 290 Add-On Code Required.....	92
EAN-13 Beginning with 378/379 Add-On Code Required.....	92
EAN-13 Beginning with 414/419 Add-On Code Required.....	93
EAN-13 Beginning with 434/439 Add-On Code Required.....	93
EAN-13 Beginning with 977 Add-On Code Required.....	94
EAN-13 Beginning with 978 Add-On Code Required.....	94
EAN-13 Beginning with 979 Add-On Code Required.....	95
UPC-E.....	96

Restore Factory Defaults.....	96
Enable/Disable UPC-E.....	96
Enable/Disable UPC-E0.....	97
Enable/Disable UPC-E1.....	97
Transmit Check Character.....	98
2-Digit Add-On Code.....	98
5-Digit Add-On Code.....	99
Add-On Code Required.....	100
Transmit Preamble Character.....	100
Convert UPC-E to UPC-A.....	101
UPC-A.....	102
Restore Factory Defaults.....	102
Enable/Disable UPC-A.....	102
Transmit Check Character.....	103
2-Digit Add-On Code.....	104
5-Digit Add-On Code.....	105
Add-On Code Required.....	106
Transmit Preamble Character.....	106
Coupon.....	107
UPC-A/EAN-13 with Extended Coupon Code.....	107
Coupon GS1 Databar Output.....	108
Interleaved 2 of 5.....	109
Restore Factory Defaults.....	109
Enable/Disable Interleaved 2 of 5.....	109
Set Length Range for Interleaved 2 of 5.....	110
Safety Level.....	111
Check Character Verification.....	112
Febraban.....	113
Disable/Enable Febraban.....	113
Transmit Delay per Character.....	113
Transmit Delay per 12 Characters.....	116
ITF-14.....	118
Restore Factory Defaults.....	118
Enable/Disable ITF-14.....	118
ITF-6.....	119
Restore Factory Defaults.....	119
Enable/Disable ITF-6.....	119

Matrix 2 of 5 .....	120
Restore Factory Defaults .....	120
Enable/Disable Matrix 2 of 5 .....	120
Set Length Range for Matrix 2 of 5 .....	121
Check Character Verification .....	122
Code 39 .....	123
Restore Factory Defaults .....	123
Enable/Disable Code 39 .....	123
Set Length Range for Code 39 .....	124
Check Character Verification .....	125
Transmit Start/Stop Character .....	126
Enable/Disable Code 39 Full ASCII .....	126
Enable/Disable Code 32 (Italian Pharma Code) .....	127
Code 32 Prefix .....	127
Transmit Code 32 Start/Stop Character .....	128
Transmit Code 32 Check Character .....	128
Codabar .....	129
Restore Factory Defaults .....	129
Enable/Disable Codabar .....	129
Set Length Range for Codabar .....	130
Check Character Verification .....	131
Start/Stop Character .....	132
Code 93 .....	133
Restore Factory Defaults .....	133
Enable/Disable Code 93 .....	133
Set Length Range for Code 93 .....	134
Check Character Verification .....	135
China Post 25 .....	136
Restore Factory Defaults .....	136
Enable/Disable China Post 25 .....	136
Set Length Range for China Post 25 .....	137
Check Character Verification .....	138
GS1-128 (UCC/EAN-128) .....	139
Restore Factory Defaults .....	139
Enable/Disable GS1-128 .....	139
Set Length Range for GS1-128 .....	140
GS1 Databar (RSS) .....	141

Restore Factory Defaults.....	141
Enable/Disable GS1 Databar .....	141
Transmit Application Identifier "01" .....	141
GS1 Composite (EAN·UCC Composite) .....	142
Restore Factory Defaults.....	142
Enable/Disable GS1 Composite.....	142
Enable/Disable UPC/EAN Composite .....	142
Code 11 .....	143
Restore Factory Defaults.....	143
Enable/Disable Code 11.....	143
Set Length Range for Code 11.....	144
Check Character Verification.....	145
Transmit Check Character.....	146
ISBN .....	147
Restore Factory Defaults.....	147
Enable/Disable ISBN.....	147
Set ISBN Format .....	148
ISSN .....	149
Restore Factory Defaults.....	149
Enable/Disable ISSN.....	149
Industrial 25 .....	150
Restore Factory Defaults.....	150
Enable/Disable Industrial 25.....	150
Set Length Range for Industrial 25.....	151
Check Character Verification.....	152
Standard 25 .....	153
Restore Factory Defaults.....	153
Enable/Disable Standard 25.....	153
Set Length Range for Standard 25.....	154
Check Character Verification.....	155
Plessey .....	156
Restore Factory Defaults.....	156
Enable/Disable Plessey.....	156
Set Length Range for Plessey.....	157
Check Character Verification.....	158
MSI-Plessey.....	159
Restore Factory Defaults.....	159

Enable/Disable MSI-Plessey .....	159
Set Length Range for MSI-Plessey .....	160
Check Character Verification.....	161
Transmit Check Character.....	162
AIM 128 .....	163
Restore Factory Defaults.....	163
Enable/Disable AIM 128.....	163
Set Length Range for AIM 128.....	164
ISBT 128.....	165
Restore Factory Defaults.....	165
Enable/Disable ISBT 128 .....	165
Code 49 .....	166
Restore Factory Defaults.....	166
Enable/Disable AIM 49.....	166
Set Length Range for Code 49.....	167
Code 16K.....	168
Restore Factory Defaults.....	168
Enable/Disable AIM 49.....	168
Set Length Range for Code 16K .....	169
PDF417.....	170
Restore Factory Defaults.....	170
Enable/Disable PDF417 .....	170
Set Length Range for PDF417 .....	171
PDF417 Twin Code .....	172
PDF417 Inverse.....	173
Character Encoding.....	173
PDF417 ECI Output .....	174
Micro PDF417.....	175
Restore Factory Defaults.....	175
Enable/Disable Micro PDF417 .....	175
Set Length Range for Micro PDF417 .....	176
QR Code.....	177
Restore Factory Defaults.....	177
Enable/Disable QR Code .....	177
Set Length Range for QR Code .....	178
QR Twin Code.....	179
QR Inverse .....	180

Character Encoding.....	180
QR ECI Output .....	181
Website QR Code.....	181
Micro QR Code .....	182
Restore Factory Defaults.....	182
Enable/Disable Micro QR .....	182
Set Length Range for Micro QR .....	183
Aztec.....	184
Restore Factory Defaults.....	184
Enable/Disable Aztec Code.....	184
Set Length Range for Aztec Code.....	185
Read Multi-barcodes on an Image .....	186
Set the Number of Barcodes .....	187
Aztec Inverse.....	188
Character Encoding.....	189
Aztec ECI Output.....	189
Data Matrix .....	190
Restore Factory Defaults.....	190
Enable/Disable Data Matrix .....	190
Set Length Range for Data Matrix.....	191
Data Matrix Twin Code.....	192
Rectangular Barcode.....	193
Data Matrix Inverse .....	193
Character Encoding.....	194
Data Matrix ECI Output .....	194
Maxicode .....	195
Restore Factory Defaults.....	195
Enable/Disable Maxicode.....	195
Set Length Range for Maxicode.....	196
Chinese Sensible Code .....	197
Restore Factory Defaults.....	197
Enable/Disable Chinese Sensible Code.....	197
Set Length Range for Chinese Sensible Code.....	198
Chinese Sensible Twin Code .....	199
Chinese Sensible Code Inverse .....	200
ECI Output.....	200
GM Code .....	201



Restore Factory Defaults.....	201
Enable/Disable GM .....	201
Set Length Range for GM .....	202
Code One .....	203
Restore Factory Defaults.....	203
Enable/Disable Code One.....	203
Set Length Range for Code One.....	204
DotCode.....	205
Restore Factory Defaults.....	205
Enable/Disable DotCode .....	205
USPS Postnet.....	206
Restore Factory Defaults.....	206
Enable/Disable USPS Postnet .....	206
Transmit Check Character.....	206
USPS Intelligent Mail.....	207
Restore Factory Defaults.....	207
Enable/Disable USPS Intelligent Mail .....	207
Royal Mail.....	208
Restore Factory Defaults.....	208
Enable/Disable Royal Mail .....	208
USPS Planet.....	209
Restore Factory Defaults.....	209
Enable/Disable USPS Planet .....	209
Transmit Check Character.....	209
KIX Post.....	210
Restore Factory Defaults.....	210
Enable/Disable KIX Post .....	210
Australian Postal.....	211
Restore Factory Defaults.....	211
Enable/Disable Australian Postal .....	211
Japan Post.....	212
Restore Factory Defaults.....	212
Enable/Disable Specific Japan Post.....	212
Passport OCR.....	213
Restore Factory Defaults.....	213
Enable/Disable Passport OCR .....	213
Chinese ID Card OCR .....	214

Restore Factory Defaults.....	214
Enable/Disable Chinese ID Card OCR.....	214
China Travel Permit OCR.....	215
Restore Factory Defaults.....	215
Enable/Disable Chinese Travel Permit OCR.....	215
<b>Chapter 6 Prefix&amp;Suffix.....</b>	<b>216</b>
Introduction.....	216
Global Settings.....	217
Enable/Disable All Prefixes/Suffixes.....	217
Prefix Sequence.....	217
Custom Prefix.....	218
Enable/Disable Custom Prefix.....	218
Set Custom Prefix.....	218
AIM ID Prefix.....	219
Code ID Prefix.....	220
Restore All Default Code IDs.....	220
Modify Code ID.....	220
Custom Suffix.....	252
Enable/Disable Custom Suffix.....	252
Set Custom Suffix.....	252
Data Packing.....	253
Introduction.....	253
Data Packing Options.....	253
Terminating Character Suffix.....	255
Enable/Disable Terminating Character Suffix.....	255
Set Terminating Character Suffix.....	255
<b>Chapter 7 Batch Programming.....</b>	<b>257</b>
Introduction.....	257
Create a Batch Command.....	258
Create a Batch Barcode.....	258
Use Batch Barcode.....	259
<b>Appendix.....</b>	<b>260</b>
Digit Barcodes.....	260
Save/Cancel Barcodes.....	263
Factory Defaults Table.....	264
AIM ID Table.....	273

Code ID Table .....	275
Symbology ID Number.....	276
ASCII Table .....	278
Unicode Key Maps .....	282



# Preface

## Introduction

This manual provides detailed instructions for setting up and using the NLS-HR3300-BT wireless 2D barcode scanner (hereinafter referred to as “**the HR3300-BT**” or “**the scanner**”).

## Chapter Description

<i>Chapter 1 Getting Started</i>	: Gives a general description of HR3300-BT scanner
<i>Chapter 2 EasySet</i>	: Introduces a useful tool you can use to set up HR3300-BT scanner.
<i>Chapter 3 System Settings</i>	: Introduces three configuration methods and describes how to configure general parameters of HR3300-BT scanner.
<i>Chapter 4 Wireless Communications</i>	: Describes how to configure the parameters necessary for wireless communication between the scanner, cradle and host device.
<i>Chapter 5 Symbologies</i>	: Lists all compatible symbologies and describes how to configure the relevant parameters.
<i>Chapter 6 Prefix &amp; Suffix</i>	: Describes how to use prefix and suffix to customize scanned data.
<i>Chapter 7 Batch Programming</i>	: Explains how to integrate a complex programming task into a single barcode.
<i>Appendix</i>	: Provides factory defaults table and a bunch of frequently used programming barcodes.

---

## Explanation of Icons



This icon indicates something relevant to this manual.



This icon indicates this information requires extra attention from the reader.



This icon indicates handy tips that can help you use or configure the scanner with ease.



This icon indicates practical examples that can help you to acquaint yourself with opera

# Chapter 1 Getting Started

## Introduction

The HR3300-BT wireless 2D barcode scanner reads a 1D or 2D barcode by capturing its image. Adopting the advanced **UING** technology independently developed by Newland Auto-ID Tech, it provides five scan modes, including Level mode, Sense mode, Continuous mode, Pulse mode and Batch mode, tailored to different scanning needs.

An illustrated introduction to the HR3300-BT is included in this chapter. If you have an HR3300-BT scanner at hand, make good use of it to develop a better understanding of this manual. This chapter is written for normal users, maintenance staff and software developers.

## Features of the HR3300-BT

- Easily reads all mainstream 1D and 2D barcodes on the market.
- Integrated with a high-performance processor and scan engine, offering fast decoding and high-precision reading capabilities.
- Stable wireless transmission technology with strong anti-interference ability.
- Easy to configure functions and update firmware.

## Unpacking

Open the package and take out HR3300-BT scanner and its accessories. Check to make sure everything on the packing list is present and intact. If any contents are damaged or missing, please keep the original package and contact your dealer immediately for after-sales service.

---

## The Scanner

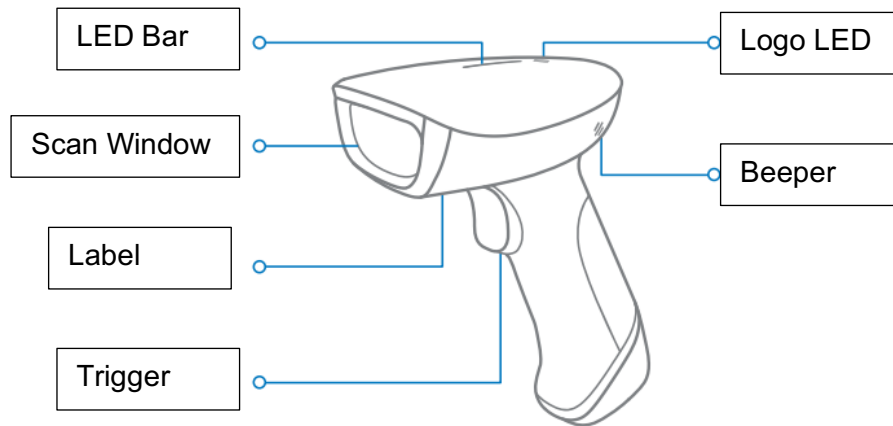

### LED Notification:

Logo LED (Battery indicator)

Red LED flashes - Low battery alert.

Red LED on – Charging

White LED on – Battery 100%

LED Bar

White LED On - Bluetooth Connection.

White LED Flash – Bluetooth Disconnection.

Green LED flashes once - Good Read.

Red LED on – Host Communication Indicator.



**Dimensions of the Scanner (unit: mm)**

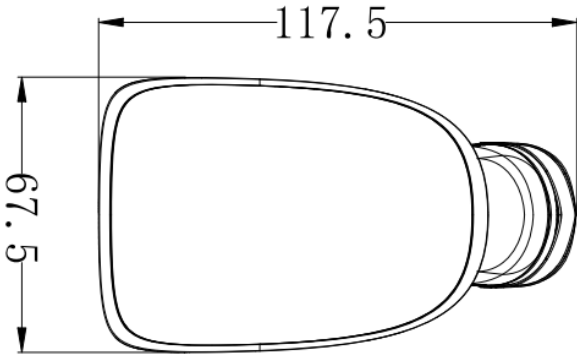
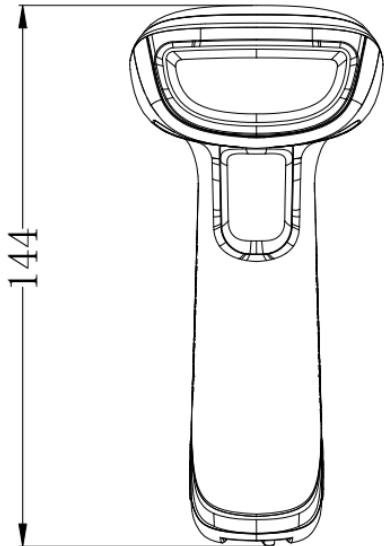
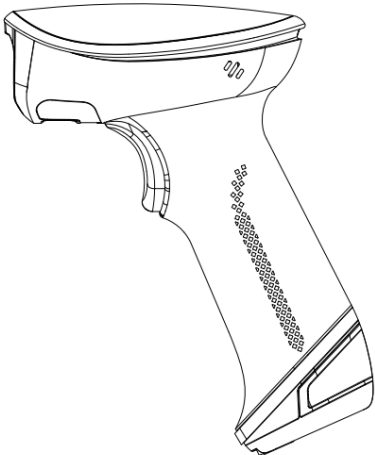

---

## HCD20 Cradle

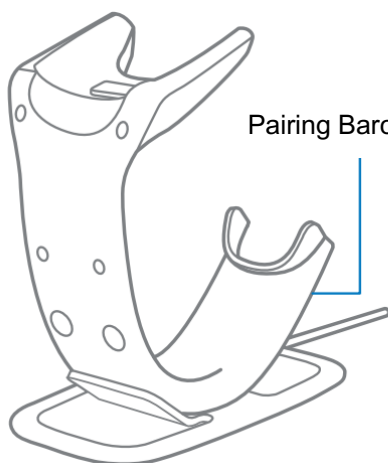
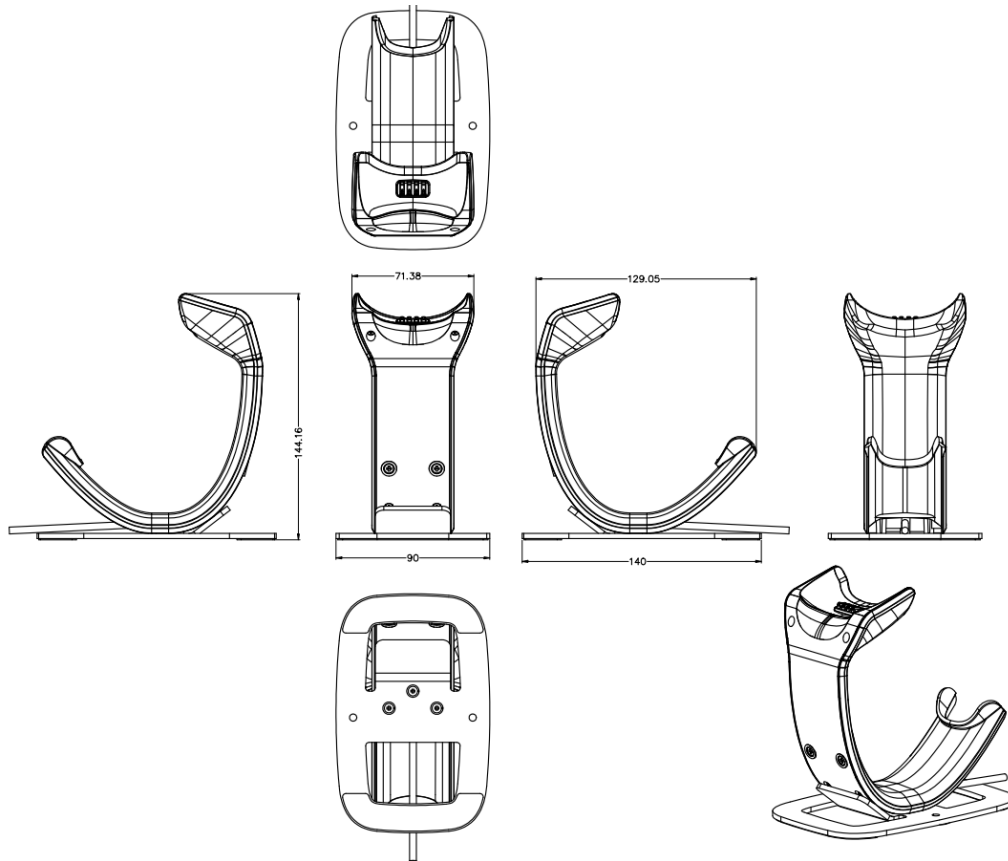

Pairing Barcode

Scanner is paired with the cradle by default.

Connect scanner with other cradles:

- 1, Power off the scanner or clear the pairing information on the scanner
- 2, Scan the pairing barcode on the bottom of cradle

## Connecting the Cradle to a Host

The cradle can be connected to a host in actual application, such as PC, POS or any intelligent terminal with USB port, using a communication cable (USB or RS-232 cable).

### USB

USB port on the Host

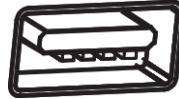

**Note:** Please check the port on the host and purchase the cable accordingly.

### Using USB Cable

Connect the cradle to a Host using a USB cable

## Pairing the Scanner to a Cradle

Before configuring or using the scanner, you must pair it to a cradle first.

You need to perform the pairing operation manually: After the scanner and cradle are turned on, insert the scanner in the cradle and then scan the Pairing Barcode on the bottom of the cradle. The scanner beeps on a successful pairing.

To unpair them, you may pair the scanner to another cradle, or scan the **Clear Pairing Info on Cradle** or **Clear Pairing Info on Scanner** barcode in Chapter 4.

## Power On, Power Off, Reboot

### Power on the scanner

Hold down the trigger on the scanner until it beeps.

Note: When using the scanner for the first time or after scanning the **Battery Off** barcode in Chapter 3, you MUST insert the scanner in a powered cradle to exit battery protection mode before turning it on.

### Power off the scanner

**Method 1:** When in the Level scan mode, the scanner will automatically power off after a specific period of inactivity (default: 5 minutes, programmable). To change the period, see the “Auto Power-Off Timeout” section in Chapter 3.

**Method 2:** Scan the **Power Off Scanner** barcode in Chapter 3.

### Reboot the scanner

If the scanner stops responding to input or runs abnormally, press and hold the Reset button on the bottom of the scanner with a straightened paperclip to reboot it.

## Chapter 2 Easyset

EasySet, developed by Fujian Newland Auto-ID Tech. Co., Ltd., is a configuration tool for Newland's 1D/2D handheld barcode scanner, fixed mount barcode scanners and OEM scan engines. Its main features include:

- ✧ View device & configuration information of online device
- ✧ Configure device
- ✧ Update firmware of online device
- ✧ Load/modify existing XML configuration file; save current settings to an XML file
- ✧ Create/print/save programming barcodes to a PDF or Word file
- ✧ View/edit/save image stored on online device in the original image/BMP/JPG/TIFF format
- ✧ Send serial commands to online device and receive device response
- ✧ Supported languages: Chinese and English.

EasySet supports 32-bit/64-bit Microsoft WinXP/Win7/Win 8/Win 8.1/Win 10 operating systems.

EasySet can communicate with device via one of the following interface: RS-232, USB COM Port Emulation (UFCOM driver required), USB CDC (UFCOM driver required), USB DataPipe (UFCOM driver required), USB HID-POS.

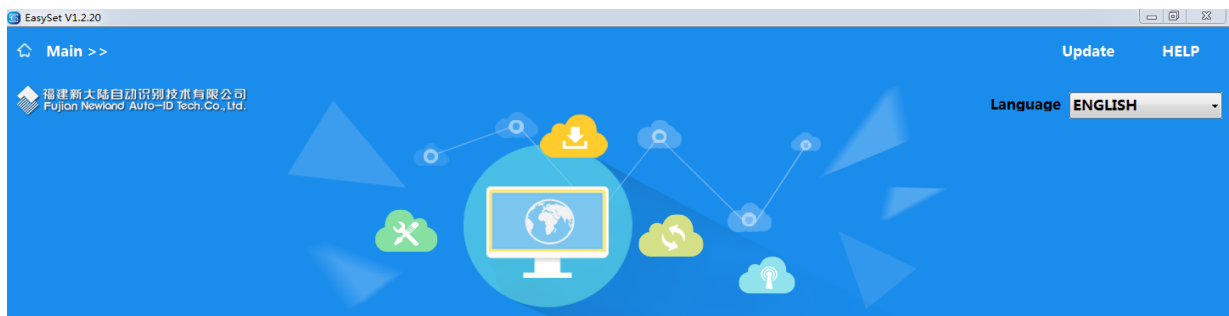

Online Device



Offline Device

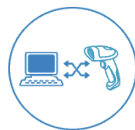

Command Center



Batch update



#SETUPE1  
Enter Setup

## Chapter 3 System Setting

### Introduction

There are three ways to configure the HR3300-BT: Barcode programming, command programming and Easyset programming.

#### Barcode Programming

The HR3300-BT can be configured by scanning programming barcodes. All user programmable features/options are described along with their programming barcodes/commands in the following sections.

This programming method is most straightforward. However, it requires manually scanning barcodes. As a result, errors are more likely to occur.

#### Command Programming

The HR3300-BT can also be configured by serial commands (HEX) sent from the host device.

Users can design an application program to send those command strings to the scanners to perform device configuration.

#### EasySet Programming

Besides the two methods mentioned above, you can conveniently perform scanner configuration through EasySet too. EasySet is a Windows-based configuration tool particularly designed for Newland products, enabling users to gain access to decoded data and captured images and to configure scanners. For more information about this tool, refer to the *EasySet User Guide*.



Before programming the scanner, you need to pair it to a cradle first. When programming the scanner with serial commands or EasySet, you need to insert it in the paired cradle.

Except some temporary setting will be disappeared after reboot and power off, other setting information will be stored in the scanner.



#SETUPE1  
Enter Setup

## Programming Barcode/ Programming Command/Function



The figure above is an example that shows you the programming barcode and command for the Enter Setup function:

1. The **No Case Conversion** barcode.
2. The **No Case Conversion** command.
3. The description of feature/option.
4. \*\* indicates factory default settings.

Note: "@" included in the programming command indicates permanent setting which means the setting will not be lost by removing power from the scanner or turning off or rebooting it; whereas "#" included in the programming command indicates temporary setting which means the setting will be lost by removing power from the scanner or turning off or rebooting it.



#SETUPE0  
\*\* Exit Setup



#SETUPE1  
**Enter Setup**

---

## Use of Programming Command

Besides the barcode programming method, the scanner can also be configured by serial commands (HEX) sent from the host device. **All commands must be entered in uppercase letters.**

## Use of Programming Barcodes

Scanning the **Enter Setup** barcode can enable the scanner to enter the setup mode. Then you can scan a number of programming barcodes to configure your scanner. To exit the setup mode, scan the **Exit Setup** barcode or a non-programming barcode, or reboot the scanner.



@SETUPE0  
**\*\* Exit Setup**



@SETUPE1  
**Enter Setup**

Programming barcode data (i.e. the characters under programming barcode) can be transmitted to the host device. You may scan the appropriate barcode below to enable or disable the transmission of programming barcode data to the host device.



#SETUPT0  
**\*\* Do Not Transmit Programming Barcode Data**



#SETUPT1  
**Transmit Programming Barcode Data**



#SETUPE0  
**\*\* Exit Setup**





#SETUPE1  
Enter Setup

---

## Illumination



@ILLSCN1  
\*\* On



@ILLSCN0  
Off

## Aiming

When scanning/capturing image, the scanner projects an aiming pattern which allows positioning the target barcode within its field of view and thus makes decoding easier.

**Normal:** The scanner projects an aiming pattern only during barcode scanning/capture.

**Always On:** Aiming pattern is constantly on after the scanner is powered on.

**Off:** Aiming pattern is off all the time.



@AMLENA1  
\*\* Normal



@AMLENA0  
Off



@AMLENA2  
Always On



#SETUPE0  
\*\* Exit Setup



#SETUPE1  
**Enter Setup**

---

## Good Read LED

The green LED can be programmed to be On or Off to indicate good read.



@GRLENA1  
**\*\* On**



@GRLENA0  
**Off**

## Good Read LED Duration

This parameter sets the amount of time the Good Read LED remains on following a good read.



@GRLDUR20  
**\*\* Short (20ms)**



@GRLDUR120  
**Medium (120ms)**



@GRLDUR220  
**Long (220ms)**



@GRLDUR320  
**Prolonged (320ms)**



@GRLDUR  
**Custom (1 - 2,500ms)**



#SETUPE0  
**\*\* Exit Setup**



#SETUPE1  
Enter Setup

---

**E**  
*xample*

#### Set the Good Read LED duration to 800ms:

1. Scan the **Enter Setup** barcode.
2. Scan the **Custom** barcode.
3. Scan the numeric barcodes “8”, “0” and “0” from the “Digit Barcodes” section in Appendix.
4. Scan the **Save** barcode from the “Save/Cancel Barcodes” section in Appendix.
5. Scan the **Exit Setup** barcode.

## Power On Beep

The scanner can be programmed to beep when it is powered on. Scan the **Off** barcode if you do not want a power on beep.



@PWBENA1  
\*\* On



@PWBENA0  
Off

## Good Read Beep

Scanning the **Off** barcode can turn off the beep that indicates successful decode; scanning the **On** barcode can turn it back on.



@GRBENA1  
\*\* On



@GRBENA0  
Off



#SETUPE0  
\*\* Exit Setup



#SETUPE1  
**Enter Setup**

---

## Good Read Beep Duration

This parameter sets the length of the beep the scanner emits on a good read. It is programmable in 1ms increments from 20ms to 300ms.



@GRBDUR40  
**Short (40ms)**



@GRBDUR80  
**\*\* Medium (80ms)**



@GRBDUR120  
**Long (120ms)**



@GRBDUR  
**Custom (20 – 300ms)**

**E**  
*example*

### Set the Good Read Beep duration to 200ms:

1. Scan the **Enter Setup** barcode.
2. Scan the **Custom** barcode.
3. Scan the numeric barcodes “2”, “0” and “0” from the “Digit Barcodes” section in Appendix.
4. Scan the **Save** barcode from the “Save/Cancel Barcodes” section in Appendix.
5. Scan the **Exit Setup** barcode.



#SETUPE0  
**\*\* Exit Setup**



#SETUPE1  
Enter Setup

## Good Read Beep Frequency

This parameter is programmable in 1Hz increments from 20Hz to 20,000Hz.



@GRBFRQ800  
Extra Low (800Hz)



@GRBFRQ1600  
Low (1600Hz)



@GRBFRQ2730  
\*\* Medium (2730Hz)



@GRBFRQ4200  
High (4200Hz)



@GRBFRQ  
Custom (20 - 20,000Hz)

**E**  
*sample*

### Set the Good Read Beep frequency to 2,000Hz:

1. Scan the **Enter Setup** barcode.
2. Scan the **Custom** barcode.
3. Scan the numeric barcodes “2”, “0”, “0” and “0” from the “Digit Barcodes” section in Appendix.
4. Scan the **Save** barcode from the “Save/Cancel Barcodes” section in Appendix.
5. Scan the **Exit Setup** barcode.



#SETUPE0  
\*\* Exit Setup



#SETUPE1  
**Enter Setup**

---

## Good Read Beep Volume



@GRBVOL0  
**\*\* Loud(20)**



@GRBVOL2  
**Low(5)**



@GRBVOL1  
**Medium(12)**



@GRBVLL  
**Custom (1-20)**

**E**  
*sample*

### Set the Good Read Beep Volume to 20

1. Scan the **Enter Setup** barcode.
2. Scan the **Custom** barcode.
3. Scan the numeric barcodes “2”, “0” from the “Digit Barcodes” section in Appendix.
4. Scan the **Save** barcode from the “Save/Cancel Barcodes” section in Appendix.
5. Scan the **Exit Setup** barcode.



#SETUPE0  
**\*\* Exit Setup**



#SETUPE1  
Enter Setup

## Remind Beep Volume

This parameter is available for reminder beep volume of the following operations: power on (for all products), power off, batch transmission, pairing the scanner to a cradle, searching paired scanner, the scanner connects on the cradle, the scanner disconnects the cradle, bluetooth connection and transmission.



@SUCVLL20  
\*\* Loud



@SUCVLL12  
Medium



@SUCVLL5  
Low



@SUCVLL0  
Mute



@SUCVLL  
Custom (0-20)

## Example

Set the above operations' beep volume to 10:

1. Scan the **Enter Setup** barcode.
2. Scan the **Beep Volume** barcode.
3. Scan the numeric barcodes "1" and "0" from the "Digit Barcodes" section in Appendix.
4. Scan the **Save** barcode from the "Save/Cancel Barcodes" section in Appendix.
5. Scan the **Exit Setup** barcode.



#SETUPE0  
\*\* Exit Setup



#SETUPE1  
Enter Setup

## Scan Mode

**Level Mode:** A trigger pull activates a decode session. The decode session continues until a barcode is decoded or you release the trigger.

**Sense Mode:** The scanner activates a decode session every time it detects a barcode presented to it. The decode session continues until a barcode is decoded or the decode session timeout expires. **Reread Timeout** can avoid undesired rereading of same barcode in a given period of time. **Sensitivity** can change the Sense Mode's sensibility to changes in images captured. **Image Stabilization Timeout** gives the scanner time to adapt to ambient environment after it decodes a barcode and "looks" for another.

**Continuous Mode:** The scanner automatically starts one decode session after another. To suspend/resume barcode reading, simply press the trigger. **Reread Timeout** can avoid undesired rereading of same barcode in a given period of time.

**Pulse Mode:** When the trigger is pulled and released, scanning is activated until a barcode is decoded or the decode session timeout expires (The decode session timeout begins when the trigger is released).

**Batch Mode:** A trigger pull activates a round of multiple decode sessions. This round of multiple scans continues until you release the trigger. Rereading the same barcode is not allowed in the same round.



@SCNMOD0  
\*\* Level Mode

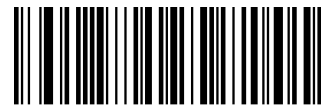

@SCNMOD2  
Sense Mode



@SCNMOD3  
Continuous Mode



@SCNMOD7  
Batch Mode



@SCNMOD4  
Pulse Mode



#SETUPE0  
\*\* Exit Setup





#SETUPE1  
**Enter Setup**

---

## Decode Session Timeout

This parameter sets the maximum time decode session continues during a scan attempt. It is programmable in 1ms increments from 100ms to 3,600,000ms. When it is set to 0, the timeout is infinite. The default setting is 3,000ms.



@ORTSET  
**Decode Session Timeout**

### **E** *Example*

#### **Set the decode session timeout to 1,500ms:**

1. Scan the **Enter Setup** barcode.
2. Scan the **Decode Session Timeout** barcode.
3. Scan the numeric barcodes “1”, “5”, “0” and “0” from the “Digit Barcodes” section in Appendix.
4. Scan the **Save** barcode from the “Save/Cancel Barcodes” section in Appendix.
5. Scan the **Exit Setup** barcode.



#SETUPE0  
**\*\* Exit Setup**



#SETUPE1

**Enter Setup**

---

## Image Stabilization Timeout (Sense Mode)

This parameter defines the amount of time the scanner will spend adapting to ambient environment after it decodes a barcode and “looks” for another. It is programmable in 1ms increments from 0ms to 3,000ms. The default setting is 200ms.



@SENIST

**Image Stabilization Timeout**

**E**  
*sample*

**Set the image stabilization timeout to 800ms:**

2. Scan the **Enter Setup** barcode.
3. Scan the **Image Stabilization Timeout** barcode.
4. Scan the numeric barcodes “8”, “0” and “0” from the “Digit Barcodes” section in Appendix.
5. Scan the **Save** barcode from the “Save/Cancel Barcodes” section in Appendix.
6. Scan the **Exit Setup** barcode.



#SETUPE0

**\*\* Exit Setup**



#SETUPE1  
**Enter Setup**

## Reread Timeout

Reread Timeout can avoid undesired rereading of same barcode in a given period of time. This feature is only applicable to the Sense and Continuous modes.

**Enable Reread Timeout:** Do not allow the scanner to reread same barcode before the reread timeout expires.

**Disable Reread Timeout:** Allow the scanner to reread same barcode.



@RRDENA1  
**Enable Reread Timeout**



@RRDENA0  
**\*\* Disable Reread Timeout**

The following parameter sets the time interval between two successive reads on same barcode. It is programmable in 1ms increments from 0ms to 3,600,000ms. When it is set to a value greater than 3,000, the timeout for rereading same programming barcode is limited to 3,000ms. The default setting is 1,500ms.



@RRDDUR  
**Set Reread Timeout**

**E**  
*xample*

**Set the reread timeout to 1,000ms:**

1. Scan the **Enter Setup** barcode.
2. Scan the **Set Reread Timeout** barcode.
3. Scan the numeric barcodes “1”, “0”, “0” and “0” from the “Digit Barcodes” section in Appendix.
4. Scan the **Save** barcode from the “Save/Cancel Barcodes” section in Appendix.
5. Scan the **Exit Setup** barcode.



#SETUPE0  
**\*\* Exit Setup**



#SETUPE1

**Enter Setup**

---

You may wish to restart the reread timeout when the scanner encounters the same barcode that was decoded in the last scan session before the reread timeout expires. To enable this feature, scan the **Reread Timeout Reset On** barcode. This feature is only effective when **Reread Timeout** is enabled.



@RRDREN1

**Reread Timeout Reset On**



@RRDREN0

**\*\* Reread Timeout Reset Off**

## Image Decoding Timeout

Image Decoding Timeout specifies the maximum time the scanner will spend decoding an image. This parameter is programmable in 1ms increments from 1ms to 3,000ms. The default timeout is 500ms.



@DETSET

**Image Decoding Timeout**

**E**  
*sample*

**Set the image decoding timeout to 1,000ms:**

1. Scan the **Enter Setup** barcode.
2. Scan the **Image Decoding Timeout** barcode.
3. Scan the numeric barcodes "1", "0", "0" and "0" from the "Digit Barcodes" section in Appendix.
4. Scan the **Save** barcode from the "Save/Cancel Barcodes" section in Appendix.
5. Scan the **Exit Setup** barcode.



#SETUPE0

**\*\* Exit Setup**



#SETUPE1  
Enter Setup

---

## Image Decoding Preference

When the scanner is set as **Barcodes on Screen**, decoding rate reduces obviously.



@DETPFN1  
**Screen Barcodes**



@DETPFN0  
**\*\* Paper Barcodes**



#SETUPE0  
**\*\* Exit Setup**



#SETUPE1

**Enter Setup**

---

## Sensitivity (Sense Mode)

This specifies the degree of acuteness of the scanner's response to changes in images captured. There are 20 levels to choose from. The smaller the value, the higher the sensitivity and the lower requirement in image change to trigger the scanner. You can select an appropriate degree of sensitivity that fits your application environment. This feature is only applicable to the Sense mode.



@SENLVL14

**Low Sensitivity**



@SENLVL11

**Medium Sensitivity**



@SENLVL8

**High Sensitivity**



@SENLVL5

**\*\*Enhanced Sensitivity**



@SENLVL

**E**  
*sample*

### Set the sensitivity to Level 10:

1. Scan the **Enter Setup** barcode.
2. Scan the **Custom Sensitivity** barcode.
3. Scan the numeric barcodes "1" and "0" from the "Digit Barcodes" section in Appendix.
4. Scan the **Save** barcode from the "Save/Cancel Barcodes" section in Appendix.
5. Scan the **Exit Setup** barcode.



#SETUPE0

**\*\* Exit Setup**



#SETUPE1  
Enter Setup

---

## Scanning Preference

**Normal Mode:** Select this mode when reading barcodes on paper.

**Screen Mode:** Select this mode when reading barcodes on the screen.



@EXPLVL0  
**\*\* Normal Mode**



@EXPLVL2  
**Screen Mode**



#SETUPE0  
**\*\* Exit Setup**



#SETUPE1  
**Enter Setup**

---

## BEL Character Beep

The beep when the scanner receives BEL character(0x07)



@BELENA1  
**On**



@BELENA0  
**\*\* Off**



#SETUPE0  
**\*\* Exit Setup**





#SETUPE1  
Enter Setup

## Surround GS1 Application Identifiers (AIs) with Parentheses

When **Surround GS1 AIs with Parentheses** is selected, each application identifier (AI) contained in scanned data will be enclosed in parentheses in the output message.



@GS1AIP0

**\*\* Do Not Surround GS1 AIs with Parentheses**



@GS1AIP1

**Surround GS1 AIs with Parentheses**

**E**  
*xample*

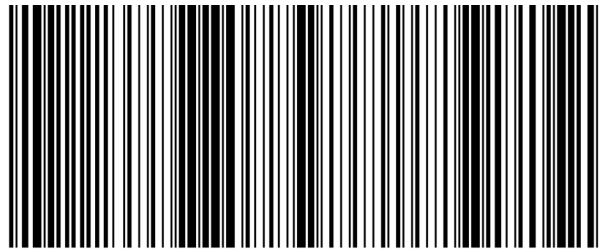

(01) 0 0614141 99999 6 (10) 10ABCEDF123456

If **Surround GS1 AIs with Parentheses** is selected, the barcode above is output as  
(01)00614141999996(10)10ABCEDF123456.

If **Do Not Surround GS1 AIs with Parentheses** is selected, the barcode above is output as  
01006141419999961010ABCEDF123456.



#SETUPE0  
**\*\* Exit Setup**



#SETUPE1  
Enter Setup

---

## Output GS1 Application Identifiers (AIs)



@GS10AI0  
Do Not Output GS1 AIs



@GS10AI1  
\*\* Output GS1 AIs

**E**  
*xample*

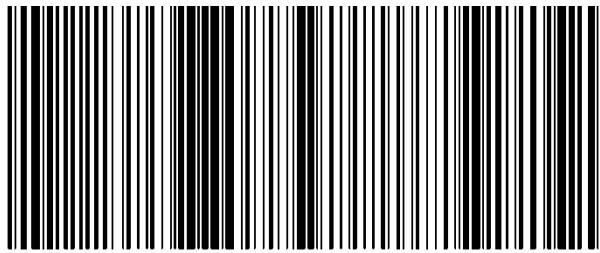

(01) 0 0614141 99999 6 (10) 10ABCEDF123456

If **Output GS1 AIs** is selected, the barcode above is output as

01006141419999961010ABCEDF123456

If **Do Not Output GS1 AIs** is selected, the barcode above is output as 0061414199999610ABCEDF123456



#SETUPE0  
\*\* Exit Setup



#SETUPE1  
Enter Setup

---

### GS1 Composite



@GS1OAC0  
Do Not Output GS1 Als



@GS1OAC1  
\*\* Output GS1 Als

### GS1 Databar(RSS)



@GS1OAR0  
Do Not Output GS1 Als



@GS1OAR1  
\*\* Output GS1 Als

### GS1 QR



@GS1O AQ0  
Do Not Output GS1 Als



@GS1O AQ1  
\*\* Output GS1 Als



#SETUPE0  
\*\* Exit Setup



#SETUPE1  
**Enter Setup**

---

### GS1 Data Matrix



@GS1OAD0  
**Do Not Output GS1 Als**



@GS1OAD1  
**\*\* Output GS1 Als**



#SETUPE0  
**\*\* Exit Setup**



#SETUPE1  
Enter Setup

## Transmit GS1 Check Character



@GS1OCK0

Do Not Transmit GS1 Check Character



@GS1OCK1

\*\* Transmit GS1 Check Character

**E**  
*xample*

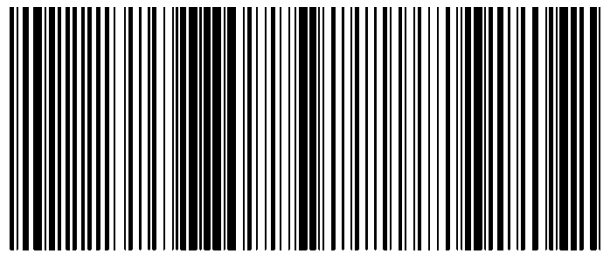

(01) 0 0614141 99999 6 (10) 10ABCEDF123456

If **Transmit GS1 Check Character** is selected, the barcode above is output as

01006141419999961010ABCEDF123456

If **Do Not Transmit GS1 Check Character** is selected, the barcode above is output as

0100614141999991010ABCEDF123456



#SETUPE0  
\*\* Exit Setup



#SETUPE1  
Enter Setup

---

## Read Barcode On/Off

Sending the Read Barcode Off command `~<SOH>0000#SCNENA0;<ETX>` to the scanner can disable it from reading barcode, and the scanner is unable to scan barcode unless you send the Read Barcode On command `~<SOH>0000#SCNENA1;<ETX>` to it or power cycle it. By default, Read Barcode is On.

## Smart Stand Mode

After this feature is turned on, the scanner will switch from its current scan mode to the Sense mode when it is inserted in the stand, and it will operate in its previous scan mode when it is removed from the stand.



@SMTENA0  
Off



@SMTENA1  
\*\* On



#SETUPE0  
\*\* Exit Setup



#SETUPE1  
Enter Setup

## Decode Area

**Whole Area Decoding:** The scanner attempts to decode barcode(s) within its field of view, from the center to the periphery, and transmits the barcode that has been first decoded.

**Specific Area Decoding:** The scanner attempts to read barcode(s) within a specified decoding area and transmits the barcode that has been first decoded. This option allows the scanner to narrow its field of view to make sure it reads only those barcodes intended by the user. For instance, if multiple barcodes are placed closely together, specific area decoding in conjunction with appropriate pre-defined decoding area will insure that only the desired barcode is read.

**Acuscan:** The scanner only decodes the barcode aimed squarely by the aiming pattern. For those using a crosshair aiming pattern, only the barcode aimed by the center of crosshair will be decoded.



@CADENA0

**\*\* Whole Area Decoding**



@CADENA1

**Specific Area Decoding**



@CADENA2

**Acuscan**

If **Specific Area Decoding** is enabled, the scanner only reads barcodes that intersect the predefined decoding area.

The default decoding area is an area of 40% top, 60% bottom, 40% left and 60% right of the scanner's field of view

You can define the decoding area using the **Top of Decoding Area**, **Bottom of Decoding Area**, **Left of Decoding Area** and **Right of Decoding Area** barcodes as well as numeric barcode(s) that represent(s) a desired percentage (0-100). The value of Bottom must be greater than that of Top; the value of Right must be greater than that of Left.



@CADTOP

**Top of Decoding Area**



#SETUPE0  
**\*\* Exit Setup**



#SETUPE1  
**Enter Setup**

---



@CABOT  
**Bottom of Decoding Area**



@CADLEF  
**Left of Decoding Area**



@CADRIG  
**Right of Decoding Area**



#SETUPE0  
**\*\* Exit Setup**





#SETUPE1  
Enter Setup

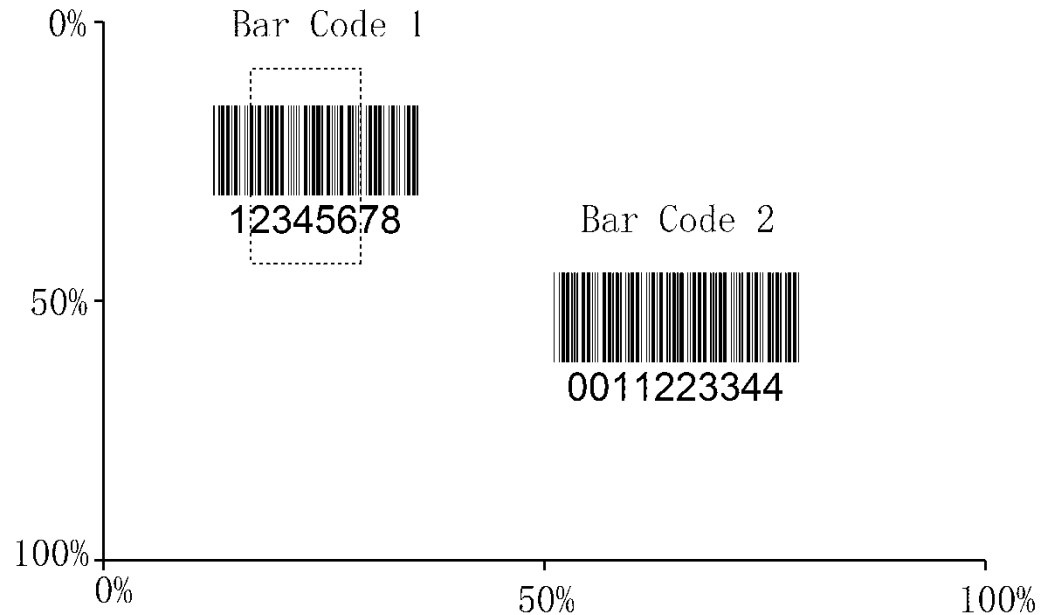

## **E** *sample*

**Program the scanner to only read Barcode 1 in the figure above by setting the decoding area to 10% top, 45% bottom, 15% left and 30% right:**

1. Scan the **Enter Setup** barcode.
2. Scan the **Top of Decoding Area** barcode.
3. Scan the numeric barcode "0" from the "Digit Barcodes" section in Appendix.
4. Scan the **Save** barcode from the "Save/Cancel Barcodes" section in Appendix.
5. Scan the **Bottom of Decoding Area** barcode.
6. Scan the numeric barcodes "4" and "5" from the "Digit Barcodes" section in Appendix.
7. Scan the **Save** barcode from the "Save/Cancel Barcodes" section in Appendix.
8. Scan the **Top of Decoding Area** barcode.
9. Scan the numeric barcodes "1" and "0" from the "Digit Barcodes" section in Appendix.
10. Scan the **Save** barcode from the "Save/Cancel Barcodes" section in Appendix.
11. Scan the **Left of Decoding Area** barcode.
12. Scan the numeric barcode "0" from the "Digit Barcodes" section in Appendix.
13. Scan the **Save** barcode from the "Save/Cancel Barcodes" section in Appendix.
14. Scan the **Right of Decoding Area** barcode.
15. Scan the numeric barcodes "3" and "0" from the "Digit Barcodes" section in Appendix.
16. Scan the **Save** barcode from the "Save/Cancel Barcodes" section in Appendix.



#SETUPE0  
**\*\* Exit Setup**



#SETUPE1

**Enter Setup**

---

17. Scan the **Left of Decoding Area** barcode.
18. Scan the numeric barcodes “1” and “5” from the “Digit Barcodes” section in Appendix.
19. Scan the **Save** barcode from the “Save/Cancel Barcodes” section in Appendix.
20. Scan the **Exit Setup** barcode.



#SETUPE0

**\*\* Exit Setup**



#SETUPE1  
Enter Setup

## Image Flipping



@MIRROR0

\*\* Do Not Flip



@MIRROR1

Flip Horizontally



@MIRROR2

Flip Vertically



@MIRROR3

Flip Horizontally & Vertically

Example of image not flipped



Example of image flipped horizontally



Example of image flipped vertically



Example of image flipped horizontally & vertically



#SETUPE0  
\*\* Exit Setup



#SETUPE1  
**Enter Setup**

---

## Bad Read Message

You may scan the appropriate barcode below to select whether or not to send a bad read message (user-programmable) when a good read does not occur before trigger release, or the decode session timeout expires.



@NGRENA0  
**\*\* Bad Read Message OFF**



@NGRENA1  
**Bad Read Message ON**

## Set Bad Read Message

A bad read message can contain up to 7 characters (HEX values from 0x00 to 0xFF). To set a bad read message, scan the **Set Bad Read Message** barcode, the numeric barcodes representing the hexadecimal values of desired character(s) and the **Save** barcode. The default setting is “NG”.



@NGRSET  
**Set Bad Read Message**

**E**  
*xample*

**Set the bad read message to “F” (HEX: 0x46):**

1. Scan the **Enter Setup** barcode.
2. Scan the **Set Bad Read Message** barcode.
3. Scan the numeric barcodes “4” and “6” from the “Digit Barcodes” section in Appendix.
4. Scan the **Save** barcode from the “Save/Cancel Barcodes” section in Appendix.
5. Scan the **Exit Setup** barcode.



#SETUPE0  
**\*\* Exit Setup**



#SETUPE1  
Enter Setup

## Power Off



@PWROFF  
Power Off Scanner

## Default Settings

### Factory Defaults

Scanning the **Reset Scanner** barcode can restore the scanner to the factory defaults. You may need to reset your scanner when:

1. Scanner is not properly configured so that the scanner fails to decode barcodes or to communicate with the cradle.
2. you forget previous configuration and want to avoid its impact.
3. functions that are rarely used have been enabled for the time being.



@FACDEF  
Reset Scanner

### Custom Defaults

Scanning the **Restore All Custom Defaults** barcode can reset all parameters on the scanner to the custom defaults. Scanning the **Save as Custom Defaults** barcode can set the current settings as custom defaults.

Custom defaults are stored in the non-volatile memory.



@CUSSAV  
Save as Custom Defaults

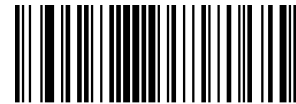

@CUSDEF  
Restore All Custom Defaults



Restoring the scanner to the factory defaults will not remove the custom defaults from the scanner.



#SETUPE0  
\*\* Exit Setup



#SETUPE1  
**Enter Setup**

---

## Query Scanner Information

After scanning the barcode below, the scanner information (including product name, firmware version, decoder version, hardware version, product serial number, OEM serial number and manufacturing date) will be sent to the host device.



@QRYSYS

**Query Scanner Information**

## Query Product Name



@QRYPDN

**Query Product Name**

## Query Firmware Version



@QRYFWW

**Query Firmware Version**

## Query Decoder Version



@QRYDCV

**Query Decoder Version**



#SETUPE0  
**\*\* Exit Setup**



#SETUPE1  
Enter Setup

---

### Query Data Formatter Version



@QRYDFM  
Query Data Formatter Version

### Query Hardware Version



@QRYHWW  
Query Hardware Version

### Query Serial Number



@QRYPSN  
Query Serial Number

### Query OEM Serial Number



@QRYESN  
Query OEM Serial Number



#SETUPE0  
\*\* Exit Setup



#SETUPE1  
Enter Setup

## Chapter 4 Wireless Communication

### Bluetooth HID



@INTERF10  
Bluetooth HID

### Bluetooth BLE



@INTERF11  
Bluetooth BLE

### Bluetooth Dongle KBW

In this mode, Bluetooth dongle equals to a keyboard



@INTERF19  
\*\*Bluetooth Dongle KBW



If the host device allows keyboard input, then no extra software is needed for HID Keyboard input.



#SETUPE0  
\*\* Exit Setup





#SETUPE1  
**Enter Setup**

---

## USB Country Keyboard Types

Keyboard layouts vary from country to country. The default setting is U.S. keyboard.



@KBWCTY0  
**\*\* U.S. (English)**

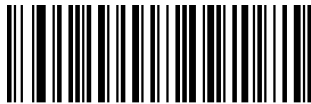

@KBWCTY2  
**Brazil**



@KBWCTY4  
**Czechoslovakia**



@KBWCTY6  
**Finland (Swedish)**



@KBWCTY1  
**Belgium**

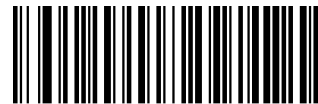

@KBWCTY3  
**Canada (French)**



@KBWCTY5  
**Denmark**



#SETUPE0  
**\*\* Exit Setup**



#SETUPE1  
**Enter Setup**

---



@KBWCTY7  
**France**



@KBWCTY8  
**Germany/ Australia**



@KBWCTY9  
**Greece**



@KBWCTY10  
**Hungary**



@KBWCTY11  
**Israel (Hebrew)**



@KBWCTY12  
**Italy**



@KBWCTY13  
**Latin America/ South America**



@KBWCTY14  
**Netherlands (Dutch)**



#SETUPE0  
**\*\* Exit Setup**



#SETUPE1

**Enter Setup**

---



@KBWCTY15

**Norway**



@KBWCTY16

**Poland**



@KBWCTY17

**Portugal**



@KBWCTY18

**Romania**



@KBWCTY19

**Russia**



@KBWCTY21

**Slovakia**



@KBWCTY22

**Spain**



@KBWCTY23

**Sweden**



#SETUPE0

**\*\* Exit Setup**



#SETUPE1

**Enter Setup**

---



@KBWCTY24

**Switzerland (German)**



@KBWCTY25

**Turkey\_F**



@KBWCTY26

**Turkey\_Q**



@KBWCTY27

**UK**



@KBWCTY28

**Japan**



#SETUPE0

**\*\* Exit Setup**



#SETUPE1  
Enter Setup

### Beep on Unknown Character

Due to the differences in keyboard layouts, some characters contained in barcode data may be unavailable on the selected keyboard. As a result, the scanner fails to transmit the unknown characters.

Scan the appropriate barcode below to enable or disable the emission of beep when an unknown character is detected.



@KBWBUC0

**\*\* Do Not Beep on Unknown Character**



@KBWBUC1

**Beep on Unknown Character**

**E**  
*sample*

Supposing French keyboard (Country Code: 7) is selected and barcode data "ADF" is being dealt with, the keyboard will fail to locate the "D" (0xD0) character and the scanner will ignore the character and continue to process the next one.

**Do Not Beep on Unknown Character:** The scanner does not beep and the Host receives "AF".

**Beep on Unknown Character:** The scanner beeps and the Host still receives "AF".



If **Emulate ALT+Keypad ON** is selected, **Beep on Unknown Character** does not function.



#SETUPE0  
**\*\* Exit Setup**



#SETUPE1  
Enter Setup

## Emulate ALT+Keypad

When **Emulate ALT+Keypad** is turned on, any character is sent via the numeric keypad and overlook USB country keyboard type. This mode need to set **Code Page Option** and **Unicode Output**. **Code Page** determines the target language. **Unicode Output** determines the ASCII input to the host device.



@KBWALTO  
\*\* Emulate ALT+Keypad OFF



@KBWALT1  
Emulate ALT+Keypad ON



ASCII characters between 0x00~0x1F will be input in way of Function Key Mapping Set.



Since sending a character involves multiple keystroke emulations, this method appears less efficient.



Supposing **Emulate ALT+Keypad** is ON, **Unicode Encoding** is Off, and **Code Page 1252 (West European Latin)** is selected, barcode data "ADF" (65/208/70) is sent as below:

"A" -- "ALT Make" + "065" + "ALT Break"

"D" -- "ALT Make" + "208" + "ALT Break"

"F" -- "ALT Make" + "070" + "ALT Break"



#SETUPE0  
\*\* Exit Setup



#SETUPE1

Enter Setup

## Code Page

Code pages define the mapping of character codes to characters. If the data received does not display with the proper characters, it may be because the barcode being scanned was created using a code page that is different from the one the host program is expecting. If this is the case, select the code page with which the barcodes were created by scanning the appropriate barcode below. For PDF417, QR Code, Aztec and Data Matrix, besides setting the code page, you also need to set the character encoding in the “Character Encoding” section in Chapter 6. This feature is only effective when **Emulate ALT+Keypad** is turned on. The default setting is Code Page 1252(West European, Latin)

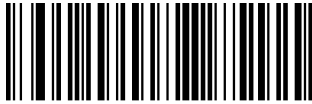

@KBWCPCG0

**\*\* Code Page 1252 (West European Latin)**



@KBWCPCG1

**Code Page 1251 (Cyrillic)**



@KBWCPCG2

**Code Page 1250 (Central and East European Latin)**



@KBWCPCG3

**Code Page 1253 (Greek)**



@KBWCPCG4

**Code Page 1254 (Turkish)**



@KBWCPCG5

**Code Page 1255 (Hebrew)**



#SETUPE0

**\*\* Exit Setup**



#SETUPE1

**Enter Setup**

---



@KBWCPG6

**Code Page 1256 (Arabic)**



@KBWCPG7

**Code Page 1257 (Baltic)**

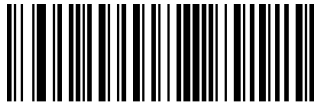

@KBWCPG8

**Code Page 1258 (Vietnamese)**

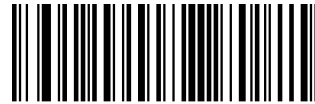

@KBWCPG9

**Code Page 936 (Simplified Chinese, GB2312,GBK)**



@KBWCPG11

**Code Page 874(Thai)**



#SETUPE0

**\*\* Exit Setup**





#SETUPE1  
Enter Setup

---

## Unicode Encoding

Different host program may use different character encodings for handling incoming barcode data. For instance, Microsoft Office Word uses Unicode encoding and therefore you should turn **Unicode Encoding** on, whereas Microsoft Office Excel or Notepad uses Code Page encoding and therefore you should turn **Unicode Encoding** off. This feature is only effective when **Emulate ALT+Keypad** is turned on. The default setting is Off



@KBWCPU0  
\*\* Off



@KBWCPU1  
On

## Emulate Keypad with Leading Zero

You may turn this feature on to send character sequences sent over the numeric keypad as ISO characters which have a leading zero. For example, ASCII A transmits as "ALT MAKE" 0065 "ALT BREAK". This feature is only effective when **Emulate ALT+Keypad** is enabled.



@KBWALZ1  
\*\* On



@KBWALZ0  
Off



#SETUPE0  
\*\* Exit Setup



#SETUPE1  
Enter Setup

---

## Function Key Mapping

When **Ctrl+ASCII Mode** is selected, function characters (0x00 - 0x1F) are sent as ASCII sequences. The default setting is Off.



@KBWFKM0  
\*\* Disable



@KBWFKM1  
**Ctrl+ASCII Mode**

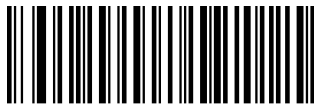

@KBWFKM2  
**Alt+Keypad Mode**

## Example

If **Ctrl+ASCII Mode** is selected and other parameters of USB HID Keyboard adopt factory defaults, barcode data “A<HT> (i.e. Horizontal Tab) F” (0x41/0x09/0x46) is sent as below:

“A” - Keystroke “A”.

<HT> - “Ctrl Make” + Keystroke “I” + “Ctrl Break”

“F” - Keystroke “F”

For some text editors, “Ctrl I” means italic convert. So the output may be “AF”.

If **Alt+Keypad Mode** is selected and other parameters of USB HID Keyboard adopt factory defaults, the data above is sent as below:

“A” - Keystroke “A”.

<HT> - “Alt Make” + Keystrokes “009” + “Alt Break”

“F” - Keystroke “F”



#SETUPE0  
\*\* Exit Setup



#SETUPE1

Enter Setup

### ASCII Function Key Mapping Table

ASCII Function	ASCII Value (HEX)	Function Key Mapping Disabled	Ctrl+ASCII
NUL	00	Null	Ctrl+@
SOH	01	Keypad Enter	Ctrl+A
STX	02	Caps Lock	Ctrl+B
ETX	03	ALT	Ctrl+C
EOT	04	Null	Ctrl+D
ENQ	05	CTRL	Ctrl+E
ACK	06	Null	Ctrl+F
BEL	07	Enter	Ctrl+G
BS	08	Left Arrow	Ctrl+H
HT	09	Horizontal Tab	Ctrl+I
LF	0A	Down Arrow	Ctrl+J
VT	0B	Vertical Tab	Ctrl+K
FF	0C	Delete	Ctrl+L
CR	0D	Enter	Ctrl+M
SO	0E	Insert	Ctrl+N
SI	0F	Esc	Ctrl+O
DLE	10	F11	Ctrl+P
DC1	11	Home	Ctrl+Q
DC2	12	PrintScreen	Ctrl+R
DC3	13	Backspace	Ctrl+S
DC4	14	tab+shift	Ctrl+T
NAK	15	F12	Ctrl+U
SYN	16	F1	Ctrl+V
ETB	17	F2	Ctrl+W
CAN	18	F3	Ctrl+X
EM	19	F4	Ctrl+Y
SUB	1A	F5	Ctrl+Z
ESC	1B	F6	Ctrl+[
FS	1C	F7	Ctrl+\
GS	1D	F8	Ctrl+]
RS	1E	F9	Ctrl+6
US	1F	F10	Ctrl+-



#SETUPE0

\*\* Exit Setup



#SETUPE1  
Enter Setup

### ASCII Function Key Mapping Table (Continued)

The last five characters (0x1B~0x1F) in the table above apply to US keyboard layout only. The following chart provides the equivalents of these five characters for other countries.

Country	Ctrl+AS CII					
United States	Ctrl +[	Ctrl+\	Ctrl+]	Ctrl+6	Ctrl +-	
Belgium	Ctrl +[	Ctrl+<	Ctrl+]	Ctrl+6	Ctrl +-	
Scandinavia	Ctrl +8	Ctrl+<	Ctrl+9	Ctrl+6	Ctrl +-	
France	Ctrl +^	Ctrl+8	Ctrl+\$	Ctrl+6	Ctrl +=	
Germany		Ctrl+Ã	Ctrl++	Ctrl+6	Ctrl +-	
Italy		Ctrl+\	Ctrl++	Ctrl+6	Ctrl +-	
Switzerland		Ctrl+<	Ctrl+..	Ctrl+6	Ctrl +-	
United Kingdom	Ctrl +[	Ctrl+ ¢	Ctrl+]	Ctrl+6	Ctrl +-	
Denmark	Ctrl +8	Ctrl+\	Ctrl+9	Ctrl+6	Ctrl +-	
Norway	Ctrl +8	Ctrl+\	Ctrl+9	Ctrl+6	Ctrl +-	
Spain	Ctrl +[	Ctrl+\	Ctrl+]	Ctrl+6	Ctrl +-	



#SETUPE0  
\*\* Exit Setup



#SETUPE1  
Enter Setup

### Inter-Keystroke Delay

This parameter specifies the delay between emulated keystrokes. Scanning below barcodes to delay longer when the host device needs slower data transmission. The default setting is No Delay.



@KBWDLY0  
\*\* No Delay



@KBWDLY40  
Long Delay (40ms)



@KBWDLY20  
Short Delay (20ms)

### Caps Lock

The **Caps Lock ON** option can invert upper and lower case characters contained in barcode data. This inversion occurs regardless of the state of Caps Lock key on the host device's keyboard.



\*\* Caps Lock OFF (Non-Japanese keyboard)



@KBWCAP1  
Caps Lock ON (Non-Japanese keyboard)



Emulate ALT+Keypad ON/ Convert All to Upper Case/ Convert All to Lower Case prevails over Caps Lock ON.



When the **Caps Lock ON** feature is selected, barcode data "AbC" is transmitted as "aBc".



#SETUPE0  
\*\* Exit Setup



#SETUPE1

Enter Setup

---

## Convert Case

Scan the appropriate barcode below to convert all barcode data to your desired case.



@KBWCAS0

\*\* No Case Conversion



@KBWCAS1

Convert All to Upper Case



@KBWCAS2

Convert All to Lower Case

**E**  
*xample*

When the **Convert All to Lower Case** feature is enabled, barcode data "AbC" is transmitted as "abc".



If **Emulate ALT+Keypad ON** is selected, **Convert All to Lower Case** and **Convert All to Upper Case** do not function.



#SETUPE0

\*\* Exit Setup



#SETUPE1  
Enter Setup

## Emulate Numeric Keypad



**Do Not Emulate Numeric Keypad 1:** Sending a number (0-9) is emulated as keystroke(s) on main keyboard.

**Emulate Numeric Keypad 1:** Sending a number (0-9) is emulated as keystroke(s) on numeric keypad. The state of Num Lock on the simulated numeric keypad is determined by its equivalent on the host device. If Num Lock on the host device is turned off, the output of simulated numeric keypad is function key instead of number.

**Do Not Emulate Numeric Keypad 2:** Sending “+”, “-”, “\*” and “/” is emulated as keystroke(s) on main keyboard.

**Emulate Numeric Keypad 2:** Sending “+”, “-”, “\*” and “/” is emulated as keystroke(s) on numeric keypad.



@KBWNUM0

**\*\* Do Not Emulate Numeric Keypad 1**



@KBWNUM1

**Emulate Numeric Keypad 1**



#SETUPE0  
**\*\* Exit Setup**



#SETUPE1  
**Enter Setup**

---



@KBWNCH0  
**\*\* Do Not Emulate Numeric Keypad 2**



@KBWNCH1  
**Emulate Numeric Keypad 2**



**Emulate ALT+Keypad ON** prevails over **Emulate Numeric Keypad**.

**E**  
*sample*

Supposing the **Emulate Numeric Keypad 1** and **Emulate Numeric Keypad 2** features are enabled:

if Num Lock on the host device is ON, "A4.5" is transmitted as "A4.5";

if Num Lock on the host device is OFF, "A4.5" is transmitted as follows:

1. "A" is sent as is because it is not included in numeric keypad;
2. "4" is sent as the function key "Cursor Move to Left";
3. "." is sent;
4. "5" is not sent as it does not correspond to any function key.

Finally the host device will get ".A"



#SETUPE0  
**\*\* Exit Setup**





#SETUPE1

Enter Setup

---

## Character "+", "-", "\*", "/" Adopt Numeric Keypad



@KBWNCH0

\*\* Off



@KBWNCH1

On



#SETUPE0

\*\* Exit Setup



#SETUPE1

**Enter Setup**

---

## Fast Mode

When **Fast Mode On** is selected, the scanner sends characters to the host faster. If the host drops characters, turn the Fast Mode off or change the polling rate to a bigger value.



@KBWFAS0

**\*\* Fast Mode Off**



@KBWFAS1

**Fast Mode On**



#SETUPE0

**\*\* Exit Setup**



#SETUPE1  
**Enter Setup**

---

## Polling Rate

This parameter specifies the polling rate for a USB keyboard. The smaller value rate is, the faster characters transmission from scanner to the host. If the host drops characters, change the polling rate to a bigger value.



@KBWPOR0  
**1ms**



@KBWPOR1  
**2ms**



@KBWPOR2  
**3ms**



@KBWPOR3  
**\*\*4ms**



@KBWPOR4  
**5ms**



@KBWPOR5  
**6ms**



@KBWPOR6  
**7ms**



#SETUPE0  
**\*\* Exit Setup**



#SETUPE1

**Enter Setup**

---



@KBWPOR7

**8ms**



@KBWPOR8

**9ms**



@KBWPOR9

**10ms**



#SETUPE0

**\*\* Exit Setup**



#SETUPE1  
**Enter Setup**

---

## Bluetooth Dongle CDC

In this is mode. the scanner equals to connect with the host via serial port



@INTERF17  
**Bluetooth Dongle CDC**



#SETUPE0  
**\*\* Exit Setup**



#SETUPE1

**Enter Setup**

---

## Bluetooth Dongle HID POS (POS HID Barcode Scanner)

### Introduction

The HID-POS interface is recommended for new application programs. It can send up to 56 characters in a single USB report and appears more efficient than keyboard emulation.

Features:

1. HID based, no custom driver required.
2. More efficient in communication than keyboard emulation interface.



@INTERF18

**Bluetooth Dongle HID-POS**

### Access the Scanner with Your Program

Use CreateFile to access the scanner as a HID device and then use ReadFile to deliver the scanned data to the application program. Use WriteFile to send data to the scanner.

For detailed information about USB and HID interfaces, go to [www.USB.org](http://www.USB.org).



#SETUPE0

**\*\* Exit Setup**



#SETUPE1  
Enter Setup

### Acquire Scanned Data

After a barcode is decoded, the scanner sends an input report as below:

Byte	Bit							
	7	6	5	4	3	2	1	0
0	Report ID = 0x02							
1	Barcode Length							
2-57	Decoded Data (1-56)							
58-61	Reserved							
62	Newland Symbology Identifier or N/C: 0x00							
63	-	-	-	-	-	-	-	Decoded data continued

### Send Command to the Scanner

This output report is used to send commands to the scanner. All programming commands can be used.

Byte	Bit							
	7	6	5	4	3	2	1	0
0	Report ID = 0x04							
1	Length of command							
2-63	Command (1-62)							



#SETUPE0  
\*\* Exit Setup



#SETUPE1

**Enter Setup**

---

## VID/PID

USB uses VID (Vendor ID) and PID (Product ID) to identify and locate a device. The VID is assigned by USB Implementers Forum. Newland's vendor ID is 1EAB (Hex). A range of PIDs are used for each Newland product family. Every PID contains a base number and interface type (keyboard, COM port, etc.).

Product	Interface	PID (Hex)	PID (Dec)
HR3300-BT	Bluetooth Dongle KBW	3A22	14882
	Bluetooth Dongle HID POS	3A10	14864
	Bluetooth Dongle CDC	3A06	14854



#SETUPE0

**\*\* Exit Setup**





#SETUPE1

**Enter Setup**

---

## Default Setting of Wireless Communication

### Clear Pairing Information of Scanner



@WLSCLP



#SETUPE0

**\*\* Exit Setup**



#SETUPE1

Enter Setup

---

## Operating Modes

The scanner provides the following operating modes:

Bluetooth HID/BLE mode allows the scanner to establish Bluetooth connection via Easyconnect.

**Bluetooth HID Mode** allows your scanner to communicate with a remote host using Bluetooth. You must first pair your scanner to the host before these two Bluetooth devices can communicate with each other. All features available for USB HID Keyboard are applicable to Bluetooth HID. Pressing the trigger twice can turn on/off iPhone and iPad's virtual keyboard.

Note: The pairing information in the scanner and the current host need to be cleared before connecting with other Bluetooth devices.

Scanner scan Clear Pairing Info on Scanner barcode, and the host delete the pairing information.

**Bluetooth BLE Mode:** The Bluetooth low energy communication mode can communicate with the host app developed based on the Bluetooth SDK. In this mode, the scanner provides a serial transparent transmission service based on GATT service.

**Cradle Mode** allows your scanner to communicate with a remote host by pairing with an HR3280-BT cradle. Cradle Mode is available only for pairing with the CD32 cardle shipped with the HR3280-BT-C



@INTERF10

**Bluetooth HID Mode**



@INTERF11

**Bluetooth BLE**



@INTERF12

**Cradle Mode**



#SETUPE0

\*\* Exit Setup



#SETUPE1

Enter Setup

## Batch Mode

### Batch Mode Options

**Off:** The scanner attempts to transmit every barcode you scan. When you are out of service range, the scanned data will be lost.

**Automatic Batch Mode:** When in service range, the scanner attempts to transmit every barcode you scan. When out of range, the scanner stores the scanned data in the flash memory. Once you are back to service range, the scanner will automatically transmit the stored data and then remove it from the flash memory after transmission is done.

**Manual Batch Mode:** Scanned data will be stored in the flash memory no matter whether you are in service range or not. You may send the stored data to the host in either of the following ways: (i) press the Batch button on the cradle after inserting the scanner in cradle; or (ii) scan the Transmit Stored Data barcode. The scanner will automatically remove the stored data from the flash memory after transmission is done if the Auto Clear Stored Data after Transmission feature is turned on.



@WLSBAT0

**\*\*Off**



@WLSBAT1

**Automatic Batch Mode**

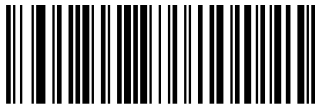

@WLSBAT2

**Manual Batch Mode**



#SETUPE0

**\*\* Exit Setup**



#SETUPE1

**Enter Setup**

---

### **Prevent Same Barcode Storage**

This feature is available only when scanning barcodes in the Automatic or Manual Batch mode.

**On:** The scanner discards the data and generates an error beep when encountering a barcode that has existed in the flash memory.

**Off:** The scanner stores the data when encountering a barcode that has existed in the flash memory.



@WLSSE0

**\*\* Off**



@WLSSE1

**On**



#SETUPE0

**\*\* Exit Setup**



#SETUPE1

**Enter Setup**

---

## Batch Mode Transmit Delay

Sometimes when multiple barcodes stored in the flash memory are sent to the host, the transmission of those barcodes is too fast for the application to process. To program a transmit delay between barcodes, scan one of the following delays.



@WLSBTD0

**\*\* No Transmit Delay (0ms)**



@WLSBTD100

**Medium Transmit Delay (100ms)**



@WLSBTD

**Custom Transmit Delay (0-10,000ms)**



@WLSBTD50

**Short Transmit Delay (50ms)**



@WLSBTD150

**Long Transmit Delay (150ms)**

**E**  
*xample*

**Set the batch mode transmit delay to 200ms:**

1. Scan the **Enter Setup** barcode.
2. Scan the **Custom Transmit Delay** barcode.
3. Scan the numeric barcodes “2”, “0” and “0” from the “Digit Barcodes” section in Appendix.
4. Scan the **Save** barcode from the “Save/Cancel Barcodes” section in Appendix.
5. Scan the **Exit Setup** barcode.



#SETUPE0

**\*\* Exit Setup**



#SETUPE1

**Enter Setup**

---

### End of Transmission Message for Batch Mode

You may scan the appropriate barcode below to select whether or not to send an end of transmission message (user-programmable) to notify the host when transmission of all stored data is done. This feature is only available to data transmission initiated manually under the Manual Batch mode.



@WLSBTT0

**\*\* End of Transmission Message Off**



@WLSBTT1

**End of Transmission Message On**

An end of transmission message can contain up to 10 characters (HEX values from 0x00 to 0xFF). To set an end of transmission message, scan the **Set End of Transmission Message** barcode, the numeric barcodes representing the hexadecimal values of desired character(s) and the **Save** barcode. The default setting is "EOT".



@WLSBTC

**Set End of Transmission Message**

**E**  
*xample*

**Set the end of transmission message to "END" (HEX: 0x45, 0x4E, 0x44):**

1. Scan the **Enter Setup** barcode.
2. Scan the **Set End of Transmission Message** barcode.
3. Scan the numeric barcodes "4", "5", "4", "E", "4" and "4" from the "Digit Barcodes" section in Appendix.
4. Scan the **Save** barcode from the "Save/Cancel Barcodes" section in Appendix.
5. Scan the **Exit Setup** barcode.



#SETUPE0

**\*\* Exit Setup**



#SETUPE1

**Enter Setup**

---

### Transmit Stored Data

You may scan the barcode below to send the stored data in the flash memory to the host. This feature is only available to the Manual Batch mode.



@WSSBT

**Transmit Stored Data**

### Auto Clear Stored Data after Transmission

You may scan the appropriate barcode below to choose whether to clear or keep the stored data in the flash memory after transmission. This feature is only available to the Manual Batch mode.



@WLSCLE0

**\*\* Off**



@WLSCLE1

**On**

### Query/Clear Stored Data in Flash



@WLSQFC

**Query the Number of Stored Barcodes**



@WLSCLF

**Clear All Stored Data**



#SETUPE0

**\*\* Exit Setup**



#SETUPE1

**Enter Setup**

---

## Auto Power-Off Timeout

Auto Power-off Timeout specifies the amount of time it takes before the scanner automatically powers off from inactivity.



@WLSAPO0

**\*\* 5 Minutes**



@WLSAPO1

**10 Minutes**



@WLSAPO2

**20 Mintues**



@WLSAPO3

**30 Mintues**



@WLSAPO4

**60 Minutes**



@WLSAPO5

**Disable Auto Power-off**



#SETUPE0

**\*\* Exit Setup**





#SETUPE1

**Enter Setup**

---

## Set Scanner Name

You may scan the below barcode to set the name of your scanner. The maximum length is 5 characters (HEX values from 0x20 to 0x7E). The default scanner name is "00000".



@WLSNAM

Scanner Name

**E**  
*example*

If setting the scanner name as "0AB00":

1. Scan the Enter Setup barcode
2. Scan the Scanner Name barcode
3. Scan the numeric barcode "3" "0" "4" "1" "4" "2" from the "Digit Barcodes" section in Appendix
4. Scan the **Save** barcode from the "Save/Cancel Barcodes" section in Appendix
5. Scan the Exit Setup barcode



#SETUPE0

**\*\* Exit Setup**



#SETUPE1

**Enter Setup**

---

## Set Date and Time



@WLSTMS

**Set Date and Time**

**E**  
*example*

Set Date and Time to “20201021010101”:

1. Scan the **Enter Setup** barcode.
2. Scan the **Set Date and Time** barcode.
3. Scan the numeric barcodes “2”, “0”, “2”, “0”, “1”, “0”, “2”, “1”, “0”, “1”, “0”, “1”, “0” and “1” from the “Digit Barcodes” section in Appendix.
4. Scan the **Save** barcode from the “Save/Cancel Barcodes” section in Appendix.
5. Scan the **Exit Setup** barcode.

## Query Current Date and Time

After scanning the barcode below, the current date and time in YYYYMMDDHHMMSS format will be sent to the host device.

For example, query result “20180205103011” means February 5<sup>th</sup> 2018 10:30:11.



@WLSTMQ

**Query Current Date and Time**



#SETUPE0

**\*\* Exit Setup**



#SETUPE1

**Enter Setup**

---

## Query Battery Status

Scan the below barcode, battery status will be showed in the host



@WLSQPW

**Query Battery Status**

## Time Stamp

You can select whether or not to send date & time before each scanned data by scanning the appropriate barcode below.



@WLSTSE0

**\*\* Do Not Send Time Stamp**



@WLSTSE1

**Send Time Stamp**



#SETUPE0

**\*\* Exit Setup**



#SETUPE1

Enter Setup

---

### Set Time Stamp Format



@WLSTSF0

**\*\* Format 1: (YYYY/MM/DD, HH: MM: SS)**

(example: 2018/01/23, 10:30:20)



@WLSTSF1

**Format 2: (DD/MM/YYYY/, HH: MM: SS)**

(example: 23/01/2018, 10:30:20)



@WLSTSF2

**Format 3: (MM/DD/YYYY,HH:MM:SS)**

(example: 01/23/2018, 10:30:20)

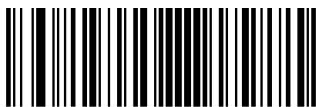

#SETUPE0

**\*\* Exit Setup**



#SETUPE1

Enter Setup

## Chapter 5 Symbologies

### Introduction

Every symbology (barcode type) has its own unique attributes. This chapter provides programming barcodes for configuring the scanner so that it can identify various symbologies. It is recommended to disable those that are rarely used to increase the efficiency of the scanner.

### Global Settings

#### Enable/Disable All Symbologies

If the **Disable All Symbologies** feature is enabled, the scanner will not be able to read any non-programming barcodes except the programming barcodes.



@ALLENA1

Enable All Symbologies



@ALLENA0

Disable All Symbologies

#### Enable/Disable 1D Symbologies



@ALL1DC1

Enable 1D Symbologies



@ALL1DC0

Disable 1D Symbologies



#SETUPE0

\*\* Exit Setup



#SETUPE1

**Enter Setup**

---

### Enable/Disable 2D Symbologies



@ALL2DC1

**Enable 2D Symbologies**



@ALL2DC0

**Disable 2D Symbologies**

### Enable/Disable Postal Symbologies



@ALLPST1

**Enable All Postal Symbologies**



@ALLPST0

**Disable All Postal Symbologies**



#SETUPE0

**\*\* Exit Setup**



#SETUPE1  
**Enter Setup**

---

## Code 128

### Restore Factory Defaults



@128DEF

**\*\*Restore the Factory Defaults of Code 128**

### Enable/Disable Code 128



@128ENA1

**\*\* Enable Code 128**



@128ENA0

**Disable Code 128**



If the scanner fails to identify Code 128 barcodes, you may first try this solution by scanning the **Enter Setup** barcode and then **Enable Code 128** barcode.



#SETUPE0  
**\*\* Exit Setup**



#SETUPE1  
**Enter Setup**

## Set Length Range for Code 128

The scanner can be configured to only decode Code 128 barcodes with lengths that fall between (inclusive) the minimum and maximum lengths. To accomplish it, you need to set the minimum and maximum lengths.



@128MIN

**Set the Minimum Length (Default: 1)**



@128MAX

**Set the Maximum Length (Default: 48)**



If minimum length is set to be greater than maximum length, the scanner only decodes Code 128 barcodes with either the minimum or maximum length. If minimum length is same as maximum length, only Code 128 barcodes with that length are to be decoded.



**Set the scanner to decode Code 128 barcodes containing between 8 and 12 characters:**

1. Scan the **Enter Setup** barcode.
2. Scan the **Set the Minimum Length** barcode.
3. Scan the numeric barcode “8” from the “Digit Barcodes” section in Appendix.
4. Scan the **Save** barcode from the “Save/Cancel Barcodes” section in Appendix.
5. Scan the **Set the Maximum Length** barcode.
6. Scan the numeric barcodes “1” and “2” from the “Digit Barcodes” section in Appendix.
7. Scan the **Save** barcode from the “Save/Cancel Barcodes” section in Appendix.
8. Scan the **Exit Setup** barcode.



#SETUPE0  
**\*\* Exit Setup**





#SETUPE1  
Enter Setup

## EAN-8

### Restore Factory Defaults



@EA8DEF

**\*\* Restore the Factory Defaults of EAN-8**

### Enable/Disable EAN-8



@EA8ENA1

**\*\* Enable EAN-8**



@EA8ENA0

**Disable EAN-8**



If the scanner fails to identify EAN-8 barcodes, you may first try this solution by scanning the **Enter Setup** barcode and then **Enable EAN-8** barcode.

### Transmit Check Character

EAN-8 is 8 digits in length with the last one as its check character used to verify the integrity of the data.



@EA8CHK2

**\*\* Transmit EAN-8 Check Character**



@EA8CHK1

**Do Not Transmit EAN-8 Check Character**



#SETUPE0  
**\*\* Exit Setup**



#SETUPE1  
Enter Setup

## 2-Digit Add-On Code

An EAN-8 barcode can be augmented with a two-digit add-on code to form a new one. In the example below, the part surrounded by blue dotted line is an EAN-8 barcode while the part circled by red dotted line is a two-digit add-on code.



@EA8AD20  
**\*\* Disable 2-Digit Add-On Code**



@EA8AD21  
**Enable 2-Digit Add-On Code**



**Disable 2-Digit Add-On Code:** The scanner decodes EAN-8 and ignores the add-on code when presented with an EAN-8 plus 2-digit add-on barcode. It can also decode EAN-8 barcodes without 2-digit add-on codes.

**Enable 2-Digit Add-On Code:** The scanner decodes a mix of EAN-8 barcodes with and without 2-digit add-on codes.

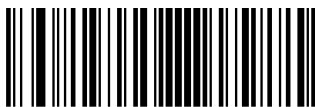

#SETUPE0  
**\*\* Exit Setup**



#SETUPE1

Enter Setup

### 5-Digit Add-On Code

An EAN-8 barcode can be augmented with a five-digit add-on code to form a new one. In the example below, the part surrounded by blue dotted line is an EAN-8 barcode while the part circled by red dotted line is a five-digit add-on code.



@EA8AD50

**\*\* Disable 5-Digit Add-On Code**



@EA8AD51

**Enable 5-Digit Add-On Code**



**Disable 5-Digit Add-On Code:** The scanner decodes EAN-8 and ignores the add-on code when presented with an EAN-8 plus 5-digit add-on barcode. It can also decode EAN-8 barcodes without 5-digit add-on codes.

**Enable 5-Digit Add-On Code:** The scanner decodes a mix of EAN-8 barcodes with and without 5-digit add-on codes.



#SETUPE0

**\*\* Exit Setup**



#SETUPE1  
Enter Setup

---

### Add-On Code Required

When **EAN-8 Add-On Code Required** is selected, the scanner will only read EAN-8 barcodes that contain add-on codes.



@EA8REQ0

\*\* EAN-8 Add-On Code Not Required



@E13REQ1

**EAN-8 Add-On Code Required**

### Convert EAN-8 to EAN-13

**Convert EAN-8 to EAN-13:** Convert EAN-8 decoded data to EAN-13 format before transmission. After conversion, the data follows EAN-13 format and is affected by EAN-13 programming selections (e.g., Check Character).

**Do Not Convert EAN-8 to EAN-13:** EAN-8 decoded data is transmitted as EAN-8 data, without conversion.



@EA8EXP0

\*\* Do Not Convert EAN-8 to EAN-13



@EA8EXP1

**Convert EAN-8 to EAN-13**

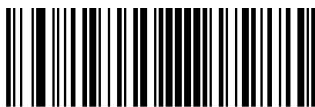

#SETUPE0  
\*\* Exit Setup



#SETUPE1  
**Enter Setup**

---

## EAN-13

### Restore Factory Defaults



@E13DEF

**\*\* Restore the Factory Defaults of EAN-13**

### Enable/Disable EAN-13



@E13ENA1

**\*\* Enable EAN-13**



@E13ENA0

**Disable EAN-13**



If the scanner fails to identify EAN-13 barcodes, you may first try this solution by scanning the **Enter Setup** barcode and then **Enable EAN-13** barcode.



#SETUPE0  
**\*\* Exit Setup**



#SETUPE1  
Enter Setup

### Transmit Check Character



@E13CHK2

\*\* Transmit EAN-13 Check Character



@E13CHK1

Do Not Transmit EAN-13 Check Character

### 2-Digit Add-On Code

An EAN-13 barcode can be augmented with a two-digit add-on code to form a new one. In the example below, the part surrounded by blue dotted line is an EAN-13 barcode while the part circled by red dotted line is a two-digit add-on code.



@E13AD20

\*\* Disable 2-Digit Add-On Code



@E13AD21

Enable 2-Digit Add-On Code



**Disable 2-Digit Add-On Code:** The scanner decodes EAN-13 and ignores the add-on code when presented with an EAN-13 plus 2-digit add-on barcode. It can also decode EAN-13 barcodes without 2-digit add-on codes.

**Enable 2-Digit Add-On Code:** The scanner decodes a mix of EAN-13 barcodes with and without 2-digit add-on codes.

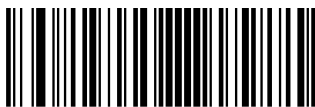

#SETUPE0  
\*\* Exit Setup



#SETUPE1

Enter Setup

### 5-Digit Add-On Code

An EAN-13 barcode can be augmented with a five-digit add-on code to form a new one. In the example below, the part surrounded by blue dotted line is an EAN-13 barcode while the part circled by red dotted line is a five-digit add-on code.



@E13AD50

\*\* Disable 5-Digit Add-On Code



@E13AD51

Enable 5-Digit Add-On Code



**Disable 5-Digit Add-On Code:** The scanner decodes EAN-13 and ignores the add-on code when presented with an EAN-13 plus 5-digit add-on barcode. It can also decode EAN-13 barcodes without 5-digit add-on codes.

**Enable 5-Digit Add-On Code:** The scanner decodes a mix of EAN-13 barcodes with and without 5-digit add-on codes.

### Add-On Code Required

When **EAN-13 Add-On Code Required** is selected, the scanner will only read EAN-13 barcodes that contain add-on codes.



@E13REQ0

\*\* EAN-13 Add-On Code Not Required



@E13REQ1

EAN-13 Add-On Code Required

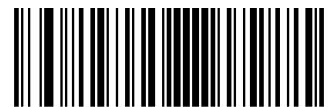

#SETUPE0

\*\* Exit Setup



#SETUPE1  
Enter Setup

### EAN-13 Beginning with 290 Add-On Code Required

This setting programs the scanner to require an add-on code (2-digit or 5-digit) on EAN-13 barcodes that begin with “290”. The following settings can be programmed:

**Require Add-On Code:** All EAN-13 barcodes that begin with “290” must have a 2-digit or 5-digit add-on code. The EAN-13 barcode with the add-on code is then transmitted. If the required add-on code is not found, the EAN-13 barcode is discarded.

**Do Not Require Add-On Code:** If you have selected **Require Add-On Code**, and you want to disable this feature, scan **Do Not Require Add-On Code**. EAN-13 barcodes are handled, depending on your selection for the “Add-On Code Required” feature.



\*\* Do Not Require Add-On Code



Require Add-On Code

### EAN-13 Beginning with 378/379 Add-On Code Required

This setting programs the scanner to require an add-on code (2-digit or 5-digit) on EAN-13 barcodes that begin with a “378” or “379”. The following settings can be programmed:

**Require Add-On Code:** All EAN-13 barcodes that begin with a “378” or “379” must have a 2-digit or 5-digit add-on code. The EAN-13 barcode with the add-on code is then transmitted. If the required add-on code is not found, the EAN-13 barcode is discarded.

**Do Not Require Add-On Code:** If you have selected **Require Add-On Code**, and you want to disable this feature, scan **Do Not Require Add-On Code**. EAN-13 barcodes are handled, depending on your selection for the “Add-On Code Required” feature.



\*\* Do Not Require Add-On Code



Require Add-On Code



#SETUPE0  
\*\* Exit Setup





#SETUPE1

Enter Setup

### EAN-13 Beginning with 414/419 Add-On Code Required

This setting programs the scanner to require an add-on code (2-digit or 5-digit) on EAN-13 barcodes that begin with a “414” or “419”. The following settings can be programmed:

**Require Add-On Code:** All EAN-13 barcodes that begin with a “414” or “419” must have a 2-digit or 5-digit add-on code. The EAN-13 barcode with the add-on code is then transmitted. If the required add-on code is not found, the EAN-13 barcode is discarded.

**Do Not Require Add-On Code:** If you have selected **Require Add-On Code**, and you want to disable this feature, scan **Do Not Require Add-On Code**. EAN-13 barcodes are handled, depending on your selection for the “Add-On Code Required” feature.



@E134140

**\*\* Do Not Require Add-On Code**



@E134141

**Require Add-On Code**

### EAN-13 Beginning with 434/439 Add-On Code Required

This setting programs the scanner to require an add-on code (2-digit or 5-digit) on EAN-13 barcodes that begin with a “434” or “439”. The following settings can be programmed:

**Require Add-On Code:** All EAN-13 barcodes that begin with a “434” or “439” must have a 2-digit or 5-digit add-on code. The EAN-13 barcode with the add-on code is then transmitted. If the required add-on code is not found, the EAN-13 barcode is discarded.

**Do Not Require Add-On Code:** If you have selected **Require Add-On Code**, and you want to disable this feature, scan **Do Not Require Add-On Code**. EAN-13 barcodes are handled, depending on your selection for the “Add-On Code Required” feature.



@E134340

**\*\* Do Not Require Add-On Code**



@E134341

**Require Add-On Code**



#SETUPE0

**\*\* Exit Setup**



#SETUPE1  
Enter Setup

### EAN-13 Beginning with 977 Add-On Code Required

This setting programs the scanner to require an add-on code (2-digit or 5-digit) on EAN-13 barcodes that begin with “977”. The following settings can be programmed:

**Require Add-On Code:** All EAN-13 barcodes that begin with “977” must have a 2-digit or 5-digit add-on code. The EAN-13 barcode with the add-on code is then transmitted. If the required add-on code is not found, the EAN-13 barcode is discarded.

**Do Not Require Add-On Code:** If you have selected **Require Add-On Code**, and you want to disable this feature, scan **Do Not Require Add-On Code**. EAN-13 barcodes are handled, depending on your selection for the “Add-On Code Required” feature.



\*\* Do Not Require Add-On Code



Require Add-On Code

### EAN-13 Beginning with 978 Add-On Code Required

This setting programs the scanner to require an add-on code (2-digit or 5-digit) on EAN-13 barcodes that begin with “978”. The following settings can be programmed:

**Require Add-On Code:** All EAN-13 barcodes that begin with “978” must have a 2-digit or 5-digit add-on code. The EAN-13 barcode with the add-on code is then transmitted. If the required add-on code is not found, the EAN-13 barcode is discarded.

**Do Not Require Add-On Code:** If you have selected **Require Add-On Code**, and you want to disable this feature, scan **Do Not Require Add-On Code**. EAN-13 barcodes are handled, depending on your selection for the “Add-On Code Required” feature.



\*\* Do Not Require Add-On Code



Require Add-On Code



#SETUPE0  
\*\* Exit Setup



#SETUPE1

Enter Setup

---

## EAN-13 Beginning with 979 Add-On Code Required

This setting programs the scanner to require an add-on code (2-digit or 5-digit) on EAN-13 barcodes that begin with “979”. The following settings can be programmed:

**Require Add-On Code:** All EAN-13 barcodes that begin with “979” must have a 2-digit or 5-digit add-on code. The EAN-13 barcode with the add-on code is then transmitted. If the required add-on code is not found, the EAN-13 barcode is discarded.

**Do Not Require Add-On Code:** If you have selected **Require Add-On Code**, and you want to disable this feature, scan **Do Not Require Add-On Code**. EAN-13 barcodes are handled, depending on your selection for the “Add-On Code Required” feature.

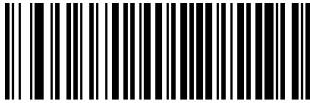

@E139790

**\*\* Do Not Require Add-On Code**



@E139791

**Require Add-On Code**



#SETUPE0

**\*\* Exit Setup**



#SETUPE1  
Enter Setup

---

## UPC-E

### Restore Factory Defaults



@UPEDEF

\*\* Restore the Factory Defaults of UPC-E

### Enable/Disable UPC-E



@UPEENA1  
\*\* Enable UPC-E



@UPEENA0  
Disable UPC-E



#SETUPE0  
\*\* Exit Setup



#SETUPE1  
**Enter Setup**

---

### Enable/Disable UPC-E0



@UPEEN01  
**\*\* Enable UPC-E0**

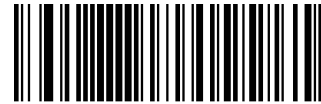

@UPEEN00  
**Disable UPC-E0**

### Enable/Disable UPC-E1



@UPEEN11  
**Enable UPC-E1**

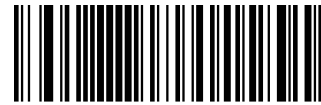

@UPEEN10  
**\*\* Disable UPC-E1**



If the scanner fails to identify UPC-E0/UPC-E1 barcodes, you may first try this solution by scanning the **Enter Setup** barcode and then **Enable UPC-E0/UPC-E1** barcode.



#SETUPE0  
**\*\* Exit Setup**



#SETUPE1  
Enter Setup

### Transmit Check Character

UPC-E is 8 digits in length with the last one as its check character used to verify the integrity of the data.



@UPECHK2  
**\*\* Transmit UPC-E Check Character**



@UPECHK1  
**Do Not Transmit UPC-E Check Character**

### 2-Digit Add-On Code

A UPC-E barcode can be augmented with a two-digit add-on code to form a new one. In the example below, the part surrounded by blue dotted line is a UPC-E barcode while the part circled by red dotted line is a two-digit add-on code.



@UPEAD20  
**\*\* Disable 2-Digit Add-On Code**



@UPEAD21  
**Enable 2-Digit Add-On Code**



**Disable 2-Digit Add-On Code:** The scanner decodes UPC-E and ignores the add-on code when presented with a UPC-E plus 2-digit add-on barcode. It can also decode UPC-E barcodes without 2-digit add-on codes.

**Enable 2-Digit Add-On Code:** The scanner decodes a mix of UPC-E barcodes with and without 2-digit add-on codes.



#SETUPE0  
**\*\* Exit Setup**



#SETUPE1

Enter Setup

### 5-Digit Add-On Code

A UPC-E barcode can be augmented with a five-digit add-on code to form a new one. In the example below, the part surrounded by blue dotted line is a UPC-E barcode while the part circled by red dotted line is a five-digit add-on code.

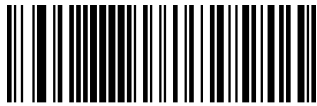

@UPEAD50

**\*\* Disable 5-Digit Add-On Code**

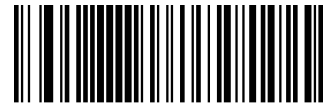

@UPEAD51

**Enable 5-Digit Add-On Code**



**Disable 5-Digit Add-On Code:** The scanner decodes UPC-E and ignores the add-on code when presented with a UPC-E plus 5-digit add-on barcode. It can also decode UPC-E barcodes without 5-digit add-on codes.

**Enable 5-Digit Add-On Code:** The scanner decodes a mix of UPC-E barcodes with and without 5-digit add-on codes.



#SETUPE0

**\*\* Exit Setup**



#SETUPE1  
Enter Setup

### Add-On Code Required

When **UPC-E Add-On Code Required** is selected, the scanner will only read UPC-E barcodes that contain add-on codes.



@UPEREQ0  
**\*\* UPC-E Add-On Code Not Required**



@UPEREQ1  
**UPC-E Add-On Code Required**

### Transmit Preamble Character

Preamble characters (Country Code and System Character) can be transmitted as part of a UPC-E barcode. Select one of the following options for transmitting UPC-E preamble to the host device: transmit system character only, transmit system character and country code ("0" for USA), or transmit no preamble.



@UPEPRE1  
**\*\* System Character**



@UPEPRE0  
**No Preamble**



@UPEPRE2  
**System Character & Country Code**



#SETUPE0  
**\*\* Exit Setup**





#SETUPE1

**Enter Setup**

---

### **Convert UPC-E to UPC-A**

**Convert UPC-E to UPC-A:** Convert UPC-E (zero suppressed) decoded data to UPC-A format before transmission. After conversion, the data follows UPC-A format and is affected by UPC-A programming selections (e.g., Preamble, Check Character).

**Do Not Convert UPC-E to UPC-A:** UPC-E decoded data is transmitted as UPC-E data, without conversion.



@UPEEXP0

**\*\* Do Not Convert UPC-E to UPC-A**

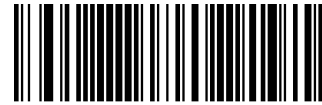

@UPEEXP1

**Convert UPC-E to UPC-A**



#SETUPE0

**\*\* Exit Setup**



#SETUPE1  
**Enter Setup**

---

## UPC-A

### Restore Factory Defaults



@UPADEF  
**Restore the Factory Defaults of UPC-A**

### Enable/Disable UPC-A



@UPAENA1  
**\*\* Enable UPC-A**



@UPAENA0  
**Disable UPC-A**



If the scanner fails to identify UPC-A barcodes, you may first try this solution by scanning the **Enter Setup** barcode and then **Enable UPC-A** barcode.



#SETUPE0  
**\*\* Exit Setup**



#SETUPE1

**Enter Setup**

---

### **Transmit Check Character**

UPC-A is 13 digits in length with the last one as its check character used to verify the integrity of the data.



@UPACHK2

**\*\* Transmit UPC-A Check Character**



@UPACHK1

**Do Not Transmit UPC-A Check Character**



#SETUPE0

**\*\* Exit Setup**



#SETUPE1  
Enter Setup

---

## 2-Digit Add-On Code

A UPC-A barcode can be augmented with a two-digit add-on code to form a new one. In the example below, the part surrounded by blue dotted line is a UPC-A barcode while the part circled by red dotted line is a two-digit add-on code.



@UPAAD20  
\*\* Disable 2-Digit Add-On Code



@UPAAD21  
Enable 2-Digit Add-On Code



**Disable 2-Digit Add-On Code:** The scanner decodes UPC-A and ignores the add-on code when presented with a UPC-A plus 2-digit add-on barcode. It can also decode UPC-A barcodes without 2-digit add-on codes.

**Enable 2-Digit Add-On Code:** The scanner decodes a mix of UPC-A barcodes with and without 2-digit add-on codes.



#SETUPE0  
\*\* Exit Setup



#SETUPE1

**Enter Setup**

### 5-Digit Add-On Code

A UPC-A barcode can be augmented with a five-digit add-on code to form a new one. In the example below, the part surrounded by blue dotted line is a UPC-A barcode while the part circled by red dotted line is a five-digit add-on code.



@UPAAD50

**\*\* Disable 5-Digit Add-On Code**



@UPAAD51

**Enable 5-Digit Add-On Code**



**Disable 5-Digit Add-On Code:** The scanner decodes UPC-A and ignores the add-on code when presented with a UPC-A plus 5-digit add-on barcode. It can also decode UPC-A barcodes without 5-digit add-on codes.

**Enable 5-Digit Add-On Code:** The scanner decodes a mix of UPC-A barcodes with and without 5-digit add-on codes.



#SETUPE0

**\*\* Exit Setup**



#SETUPE1  
Enter Setup

---

### Add-On Code Required

When **UPC-A Add-On Code Required** is selected, the scanner will only read UPC-A barcodes that contain add-on codes.



@UPAREQ0

**\*\* UPC-A Add-On Code Not Required**



@UPAREQ1

**UPC-A Add-On Code Required**

### Transmit Preamble Character

Preamble characters (Country Code and System Character) can be transmitted as part of a UPC-A barcode. Select one of the following options for transmitting UPC-A preamble to the host device: transmit system character only, transmit system character and country code ("0" for USA), or transmit no preamble.



@UPAPRE0

**\*\*No Preamble**



@UPAPRE1

**System Character**



@UPAPRE2

**System Character & Country Code**



#SETUPE0  
**\*\* Exit Setup**



#SETUPE1

Enter Setup

## Coupon

### UPC-A/EAN-13 with Extended Coupon Code

The following three types of coupon code + extended coupon code are supported:

- ◇ UPC-A (starting with “5”) + GS1-128
- ◇ UPC-A (starting with “5”) + GS1 Databar
- ◇ EAN-13 (starting with “99”) + GS1-128

Use the appropriate barcode below to enable or disable UPC-A/EAN-13 with Extended Coupon Code. When left on the default setting (**Off**), the scanner treats Coupon Codes and Extended Coupon Codes as single barcodes.

If you scan the **Allow Concatenation** code, when the scanner sees the coupon code and the extended coupon code in a single scan, it transmits both as separate symbologies. Otherwise, it transmits the first coupon code it reads.

If you scan the **Require Concatenation** code, the scanner must see and read the coupon code and extended coupon code in a single read to transmit the data. No data is output unless both codes are read.



@CPNENA0

\*\* Off



@CPNENA1

Allow Concatenation



@CPNENA2

Require Concatenation



When using the UPC-A Coupon feature, please ensure that **System Character** or **System Character & Country Code** is selected for the “Transmit UPC-A Preamble Character” feature.



#SETUPE0

\*\* Exit Setup



#SETUPE1  
Enter Setup

---

### Coupon GS1 Databar Output

If you scan coupons that have both UPC and GS1 Databar codes, you may wish to scan and output only the data from the GS1 Databar code. Scan the **GS1 Output On** barcode below to scan and output only the GS1 Databar code data.

When **GS1 Output Off** is selected, coupons that have both UPC and GS1 Databar codes are transmitted depending on your selection for the “UPC-A/EAN-13 with Extended Coupon Code” feature.

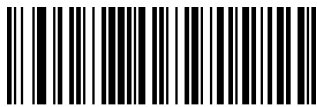

@CPNGS10  
**\*\* GS1 Output Off**



@CPNGS11  
**GS1 Output On**



When using the UPC-A Coupon feature, please ensure that **System Character** or **System Character & Country Code** is selected for the “Transmit UPC-A Preamble Character” feature.

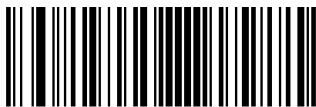

#SETUPE0  
**\*\* Exit Setup**





#SETUPE1  
**Enter Setup**

---

## Interleaved 2 of 5

### Restore Factory Defaults



@I25DEF

**Restore the Factory Defaults of Interleaved 2 of 5**

### Enable/Disable Interleaved 2 of 5



@I25ENA1

**\*\* Enable Interleaved 2 of 5**



@I25ENA0

**Disable Interleaved 2 of 5**



If the scanner fails to identify Interleaved 2 of 5 barcodes, you may first try this solution by scanning the **Enter Setup** barcode and then **Enable Interleaved 2 of 5** barcode.



#SETUPE0  
**\*\* Exit Setup**



#SETUPE1  
Enter Setup

## Set Length Range for Interleaved 2 of 5

The scanner can be configured to only decode Interleaved 2 of 5 barcodes with lengths that fall between (inclusive) the minimum and maximum lengths. To accomplish it, you need to set the minimum and maximum lengths.



@I25MIN

**Set the Minimum Length (Default: 6)**



@I25MAX

**Set the Maximum Length (Default: 80)**



If minimum length is set to be greater than maximum length, the scanner only decodes Interleaved 2 of 5 barcodes with either the minimum or maximum length. If minimum length is same as maximum length, only Interleaved 2 of 5 barcodes with that length are to be decoded.



**Set the scanner to decode Interleaved 2 of 5 barcodes containing between 8 and 12 characters:**

1. Scan the **Enter Setup** barcode.
2. Scan the **Set the Minimum Length** barcode.
3. Scan the numeric barcode “8” from the “Digit Barcodes” section in Appendix.
4. Scan the **Save** barcode from the “Save/Cancel Barcodes” section in Appendix.
5. Scan the **Set the Maximum Length** barcode.
6. Scan the numeric barcodes “1” and “2” from the “Digit Barcodes” section in Appendix.
7. Scan the **Save** barcode from the “Save/Cancel Barcodes” section in Appendix.
8. Scan the **Exit Setup** barcode.

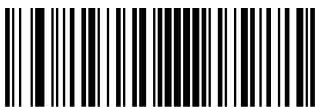

#SETUPE0  
\*\* Exit Setup



#SETUPE1

Enter Setup

---

### Safety Level

High Safety Level can improve decoding performance



@I25SEC0

\*\* Interleaved 2 of 5 Level 1



@I25SEC2

Interleaved 2 of 5 Level 3



@I25SEC1

Interleaved 2 of 5 Level 2



@I25SEC3

Interleaved 2 of 5 Level 4

High Safety Level can improve decoding performance but slow decoding speed



#SETUPE0

\*\* Exit Setup



#SETUPE1  
Enter Setup

### Check Character Verification

A check character is optional for Interleaved 2 of 5 and can be added as the last character. It is a calculated value used to verify the integrity of the data.

- ◇ **Disable:** The scanner transmits Interleaved 2 of 5 barcodes as is.
- ◇ **Do Not Transmit Check Character After Verification:** The scanner checks the integrity of all Interleaved 2 of 5 barcodes to verify that the data complies with the check character algorithm. Barcodes passing the check will be transmitted except the last digit, whereas those failing it will not be transmitted.
- ◇ **Transmit Check Character After Verification:** The scanner checks the integrity of all Interleaved 2 of 5 barcodes to verify that the data complies with the check character algorithm. Barcodes passing the check will be transmitted, whereas those failing it will not be transmitted.

Since Interleaved 2 of 5 must always have an even number of digits, a zero may need to be added as the first digit when the check character is added. The check character is automatically generated when making Interleaved 2 of 5 barcodes.



@I25CHK0  
\*\* Disable



@I25CHK1

**Do Not Transmit Check Character After Verification**



@I25CHK2

**Transmit Check Character After Verification**



If the **Do Not Transmit Check Character After Verification** option is enabled, Interleaved 2 of 5 barcodes with a length that is less than the configured minimum length after having the check character excluded will not be decoded. (For example, when the **Do Not Transmit Check Character After Verification** option is enabled and the minimum length is set to 4, Interleaved 2 of 5 barcodes with a total length of 4 characters including the check character cannot be read.)



#SETUPE0  
\*\* Exit Setup



#SETUPE1

Enter Setup

---

## Febraban

### Disable/Enable Febraban



@I25FBB0

\*\* Disable Febraban



@I25FBB1

Enable Febraban, Do Not Expand



@I25FBB2

Enable Febraban, Expand

### Transmit Delay per Character

**Transmit Delay per Character** applies to both Expanded and Unexpanded Febraban. This feature is available only when USB HID Keyboard is enabled.



@FEBSNO

\*\* Disable Transmit Delay per Character



@FEBSN1

Enable Transmit Delay per Character



#SETUPE0

\*\* Exit Setup



#SETUPE1  
**Enter Setup**

---

You may select an appropriate delay value from the options below as per your actual needs.



@FEBSDT0  
**0ms**



@FEBSDT5  
**5ms**



@FEBSDT10  
**10ms**



@FEBSDT15  
**15ms**



@FEBSDT20  
**20ms**



@FEBSDT25  
**25ms**



@FEBSDT30  
**30ms**



@FEBSDT35  
**35ms**



#SETUPE0  
**\*\* Exit Setup**



#SETUPE1  
Enter Setup

---



@FEBSDT40  
40ms



@FEBSDT45  
45ms

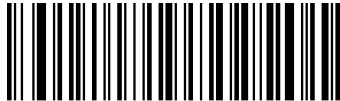

@FEBSDT50  
50ms



@FEBSDT55  
55ms



@FEBSDT60  
60ms



@FEBSDT65  
65ms

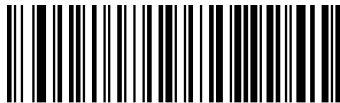

@FEBSDT70  
\*\* 70ms



@FEBSDT75  
75ms

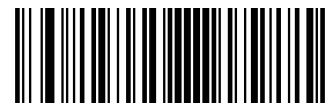

#SETUPE0  
\*\* Exit Setup



#SETUPE1  
**Enter Setup**

---

### Transmit Delay per 12 Characters

**Transmit Delay per 12 Characters** applies to Expanded Febraban only. This feature is available only when USB HID Keyboard is enabled.



@FEBMENO

**\*\* Disable Transmit Delay per 12 Characters**



@FEBMEN1

**Enable Transmit Delay per 12 Characters**

You may select an appropriate delay value from the options below as per your actual needs.



@FEBMDT0

**0ms**



@FEBMDT1

**300ms**



@FEBMDT2

**400ms**



#SETUPE0  
**\*\* Exit Setup**





#SETUPE1  
**Enter Setup**

---



@FEBMDT3  
**\*\* 500ms**



@FEBMDT4  
**600ms**



@FEBMDT5  
**700ms**



@FEBMDT6  
**800ms**



@FEBMDT7  
**900ms**



#SETUPE0  
**\*\* Exit Setup**



#SETUPE1  
**Enter Setup**

## ITF-14

ITF-14 is a special kind of Interleaved 2 of 5 with a length of 14 characters and the last character as the check character.

ITF-14 priority principle: For the Interleaved 2 of 5 barcodes with a length of 14 characters and the last character as the check character, the ITF-14 configurations shall take precedence over the Interleaved 2 of 5 settings.

### Restore Factory Defaults



@I14DEF  
**Restore the Factory Defaults of ITF-14**

### Enable/Disable ITF-14



@I14ENA0  
**\*\* Disable ITF-14**



@I14ENA1  
**Enable ITF-14 But Do Not Transmit Check Character**



@I14ENA2  
**Enable ITF-14 and Transmit Check Character**



An example of the ITF-14 priority principle: when ITF-14 is enabled and Interleaved 2 of 5 is disabled, the scanner only decodes Interleaved 2 of 5 barcodes with a length of 14 characters and the last character as the check character.



#SETUPE0  
**\*\* Exit Setup**



#SETUPE1

**Enter Setup**

## ITF-6

ITF-6 is a special kind of Interleaved 2 of 5 with a length of 6 characters and the last character as the check character.

ITF-6 priority principle: For the Interleaved 2 of 5 barcodes with a length of 6 characters and the last character as the check character, the ITF-6 configurations shall take precedence over the Interleaved 2 of 5 settings.

### Restore Factory Defaults



@IT6DEF

**Restore the Factory Defaults of ITF-6**

### Enable/Disable ITF-6



@IT6ENA0

**\*\* Disable ITF-6**



@IT6ENA1

**Enable ITF-6 But Do Not Transmit Check Character**



@IT6ENA2

**Enable ITF-6 and Transmit Check Character**



An example of the ITF-6 priority principle: when ITF-6 is enabled and Interleaved 2 of 5 is disabled, the scanner only decodes Interleaved 2 of 5 barcodes with a length of 6 characters and the last character as the check character.



#SETUPE0

**\*\* Exit Setup**



#SETUPE1  
**Enter Setup**

---

## Matrix 2 of 5

### Restore Factory Defaults



@M25DEF  
**Restore the Factory Defaults of Matrix 2 of 5**

### Enable/Disable Matrix 2 of 5



@M25ENA1  
**\*\* Enable Matrix 2 of 5**



@M25ENA0  
**Disable Matrix 2 of 5**



If the scanner fails to identify Matrix 2 of 5 barcodes, you may first try this solution by scanning the **Enter Setup** barcode and then **Enable Matrix 2 of 5** barcode.

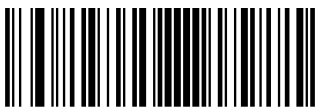

#SETUPE0  
**\*\* Exit Setup**



#SETUPE1

**Enter Setup**

---

## Set Length Range for Matrix 2 of 5

The scanner can be configured to only decode Matrix 2 of 5 barcodes with lengths that fall between (inclusive) the minimum and maximum lengths. To accomplish it, you need to set the minimum and maximum lengths.



@M25MIN

**Set the Minimum Length (Default: 4)**



@M25MAX

**Set the Maximum Length (Default: 80)**



If minimum length is set to be greater than maximum length, the scanner only decodes Matrix 2 of 5 barcodes with either the minimum or maximum length. If minimum length is same as maximum length, only Matrix 2 of 5 barcodes with that length are to be decoded.



**Set the scanner to decode Matrix 2 of 5 barcodes containing between 8 and 12 characters:**

1. Scan the **Enter Setup** barcode.
2. Scan the **Set the Minimum Length** barcode.
3. Scan the numeric barcode “8” from the “Digit Barcodes” section in Appendix.
4. Scan the **Save** barcode from the “Save/Cancel Barcodes” section in Appendix.
5. Scan the **Set the Maximum Length** barcode.
6. Scan the numeric barcodes “1” and “2” from the “Digit Barcodes” section in Appendix.
7. Scan the **Save** barcode from the “Save/Cancel Barcodes” section in Appendix.
8. Scan the **Exit Setup** barcode.



#SETUPE0

**\*\* Exit Setup**



#SETUPE1  
Enter Setup

## Check Character Verification

A check character is optional for Matrix 2 of 5 and can be added as the last character. It is a calculated value used to verify the integrity of the data.

- ◇ **Disable:** The scanner transmits Matrix 2 of 5 barcodes as is.
- ◇ **Do Not Transmit Check Character After Verification:** The scanner checks the integrity of all Matrix 2 of 5 barcodes to verify that the data complies with the check character algorithm. Barcodes passing the check will be transmitted except the last digit, whereas those failing it will not be transmitted.
- ◇ **Transmit Check Character After Verification:** The scanner checks the integrity of all Matrix 2 of 5 barcodes to verify that the data complies with the check character algorithm. Barcodes passing the check will be transmitted, whereas those failing it will not be transmitted.

Since Matrix 2 of 5 must always have an even number of digits, a zero may need to be added as the first digit when the check character is added. The check character is automatically generated when making Matrix 2 of 5 barcodes.



@M25CHK0  
\*\* Disable



@M25CHK1

**Do Not Transmit Check Character After Verification**



@M25CHK2

**Transmit Check Character After Verification**



If the **Do Not Transmit Check Character After Verification** option is enabled, Matrix 2 of 5 barcodes with a length that is less than the configured minimum length after having the check character excluded will not be decoded. (For example, when the **Do Not Transmit Check Character After Verification** option is enabled and the minimum length is set to 4, Matrix 2 of 5 barcodes with a total length of 4 characters including the check character cannot be read.)



#SETUPE0  
\*\* Exit Setup



#SETUPE1  
**Enter Setup**

---

## Code 39

### Restore Factory Defaults



@C39DEF  
**Restore the Factory Defaults of Code 39**

### Enable/Disable Code 39



@C39ENA1  
**\*\* Enable Code 39**



@C39ENA0  
**Disable Code 39**



If the scanner fails to identify Code 39 barcodes, you may first try this solution by scanning the **Enter Setup** barcode and then **Enable Code 39** barcode.



#SETUPE0  
**\*\* Exit Setup**



#SETUPE1  
Enter Setup

## Set Length Range for Code 39

The scanner can be configured to only decode Code 39 barcodes with lengths that fall between (inclusive) the minimum and maximum lengths. To accomplish it, you need to set the minimum and maximum lengths.



@C39MIN

Set the Minimum Length (Default: 1)



@C39MAX

Set the Maximum Length (Default: 48)



If minimum length is set to be greater than maximum length, the scanner only decodes Code 39 barcodes with either the minimum or maximum length. If minimum length is same as maximum length, only Code 39 barcodes with that length are to be decoded.

## Example

Set the scanner to decode Code 39 barcodes containing between 8 and 12 characters:

1. Scan the **Enter Setup** barcode.
2. Scan the **Set the Minimum Length** barcode.
3. Scan the numeric barcode “8” from the “Digit Barcodes” section in Appendix.
4. Scan the **Save** barcode from the “Save/Cancel Barcodes” section in Appendix.
5. Scan the **Set the Maximum Length** barcode.
6. Scan the numeric barcodes “1” and “2” from the “Digit Barcodes” section in Appendix.
7. Scan the **Save** barcode from the “Save/Cancel Barcodes” section in Appendix.
8. Scan the **Exit Setup** barcode.



#SETUPE0  
\*\* Exit Setup





#SETUPE1

Enter Setup

## Check Character Verification

A check character is optional for Code 39 and can be added as the last character. It is a calculated value used to verify the integrity of the data.

- ◇ **Disable:** The scanner transmits Code 39 barcodes as is.
- ◇ **Do Not Transmit Check Character After Verification:** The scanner checks the integrity of all Code 39 barcodes to verify that the data complies with the check character algorithm. Barcodes passing the check will be transmitted except the last digit, whereas those failing it will not be transmitted.
- ◇ **Transmit Check Character After Verification:** The scanner checks the integrity of all Code 39 barcodes to verify that the data complies with the check character algorithm. Barcodes passing the check will be transmitted, whereas those failing it will not be transmitted.



@C39CHK0

\*\* Disable



@C39CHK1

Do Not Transmit Check Character After Verification



@C39CHK2

Transmit Check Character After Verification



If the **Do Not Transmit Check Character After Verification** option is enabled, Code 39 barcodes with a length that is less than the configured minimum length after having the check character excluded will not be decoded. (For example, when the **Do Not Transmit Check Character After Verification** option is enabled and the minimum length is set to 4, Code 39 barcodes with a total length of 4 characters including the check character cannot be read.)



#SETUPE0

\*\* Exit Setup



#SETUPE1  
**Enter Setup**

---

### Transmit Start/Stop Character

Code 39 uses an asterisk (\*) for both the start and the stop characters. You can choose whether or not to transmit the start/stop characters by scanning the appropriate barcode below.



@C39TSC0

**\*\* Do Not Transmit Start/Stop Character**



@C39TSC1

**Transmit Start/Stop Character**

### Enable/Disable Code 39 Full ASCII

The scanner can be configured to identify all ASCII characters by scanning the appropriate barcode below.



@C39ASC0

**\*\* Disable Code 39 Full ASCII**



@C39ASC1

**Enable Code 39 Full ASCII**



#SETUPE0  
**\*\* Exit Setup**



#SETUPE1

**Enter Setup**

---

### **Enable/Disable Code 32 (Italian Pharma Code)**

Code 32 is a variant of Code 39 used by the Italian pharmaceutical industry. Scan the appropriate barcode below to enable or disable Code 32. Code 39 must be enabled and Code 39 check character verification must be disabled for this parameter to function.



@C39E320

**\*\* Disable Code 32**



@C39E321

**Enable Code 32**

### **Code 32 Prefix**

You may scan the appropriate barcode below to enable or disable adding the prefix character "A" to all Code 32 barcodes. Code 32 must be enabled for this parameter to function.



@C39S320

**\*\* Disable Code 32 Prefix**



@C39S321

**Enable Code 32 Prefix**



#SETUPE0

**\*\* Exit Setup**



#SETUPE1  
Enter Setup

---

### Transmit Code 32 Start/Stop Character

Code 32 must be enabled for this parameter to function.



@C39T320

\*\* Do Not Transmit Code 32 Start/Stop Character



@C39T321

Transmit Code 32 Start/Stop Character

### Transmit Code 32 Check Character

Code 32 must be enabled for this parameter to function.



@C39C320

\*\* Do Not Transmit Code 32 Check Character



@C39C321

Transmit Code 32 Check Character

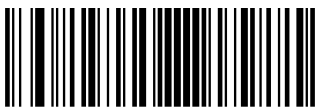

#SETUPE0  
\*\* Exit Setup



#SETUPE1  
**Enter Setup**

---

## Codabar

### Restore Factory Defaults



@CBADEF  
**Restore the Factory Defaults of Codabar**

### Enable/Disable Codabar



@CBAENA1  
**\*\* Enable Codabar**



@CBAENA0  
**Disable Codabar**



If the scanner fails to identify Codabar barcodes, you may first try this solution by scanning the **Enter Setup** barcode and then **Enable Codabar** barcode.



#SETUPE0  
**\*\* Exit Setup**



#SETUPE1  
**Enter Setup**

### Set Length Range for Codabar

The scanner can be configured to only decode Codabar barcodes with lengths that fall between (inclusive) the minimum and maximum lengths. To accomplish it, you need to set the minimum and maximum lengths.



**Set the Minimum Length (Default: 2)**



**Set the Maximum Length (Default: 60)**



If minimum length is set to be greater than maximum length, the scanner only decodes Codabar barcodes with either the minimum or maximum length. If minimum length is same as maximum length, only Codabar barcodes with that length are to be decoded.

**E**  
*sample*

**Set the scanner to decode Codabar barcodes containing between 8 and 12 characters:**

1. Scan the **Enter Setup** barcode.
2. Scan the **Set the Minimum Length** barcode.
3. Scan the numeric barcode “8” from the “Digit Barcodes” section in Appendix.
4. Scan the **Save** barcode from the “Save/Cancel Barcodes” section in Appendix.
5. Scan the **Set the Maximum Length** barcode.
6. Scan the numeric barcodes “1” and “2” from the “Digit Barcodes” section in Appendix.
7. Scan the **Save** barcode from the “Save/Cancel Barcodes” section in Appendix.
8. Scan the **Exit Setup** barcode.



#SETUPE0  
**\*\* Exit Setup**



#SETUPE1

Enter Setup

## Check Character Verification

A check character is optional for Codabar and can be added as the last character. It is a calculated value used to verify the integrity of the data.

- ◇ **Disable:** The scanner transmits Codabar barcodes as is.
- ◇ **Do Not Transmit Check Character After Verification:** The scanner checks the integrity of all Codabar barcodes to verify that the data complies with the check character algorithm. Barcodes passing the check will be transmitted except the last digit, whereas those failing it will not be transmitted.
- ◇ **Transmit Check Character After Verification:** The scanner checks the integrity of all Codabar barcodes to verify that the data complies with the check character algorithm. Barcodes passing the check will be transmitted, whereas those failing it will not be transmitted.

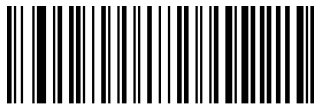

@CBACHK0

\*\* Disable



@CBACHK1

Do Not Transmit Check Character After Verification



@CBACHK2

Transmit Check Character After Verification



If the **Do Not Transmit Check Character After Verification** option is enabled, Codabar barcodes with a length that is less than the configured minimum length after having the check character excluded will not be decoded. (For example, when the **Do Not Transmit Check Character After Verification** option is enabled and the minimum length is set to 4, Codabar barcodes with a total length of 4 characters including the check character cannot be read.)



#SETUPE0

\*\* Exit Setup



#SETUPE1  
Enter Setup

---

### Start/Stop Character

You can set the start/stop characters and choose whether or not to transmit the start/stop characters by scanning the appropriate barcode below.



@CBATSC0

**\*\* Do Not Transmit Start/Stop Character**



@CBATSC1

**Transmit Start/Stop Character**



@CBASCF0

**\*\* ABCD/ABCD as the Start/Stop Character**



@CBASCF1

**ABCD/TN\*E as the Start/Stop Character**



@CBASCF2

**abcd/abcd as the Start/Stop Character**



@CBASCF3

**abcd/tn\*e as the Start/Stop Character**



#SETUPE0  
**\*\* Exit Setup**





#SETUPE1  
**Enter Setup**

---

## Code 93

### Restore Factory Defaults



@C93DEF  
**Restore the Factory Defaults of Code 93**

### Enable/Disable Code 93



@C93ENA1  
**\*\* Enable Code 93**



@C93ENA0  
**Disable Code 93**



If the scanner fails to identify Code 93 barcodes, you may first try this solution by scanning the **Enter Setup** barcode and then **Enable Code 93** barcode.



#SETUPE0  
**\*\* Exit Setup**



#SETUPE1  
**Enter Setup**

### Set Length Range for Code 93

The scanner can be configured to only decode Code 93 barcodes with lengths that fall between (inclusive) the minimum and maximum lengths. To accomplish it, you need to set the minimum and maximum lengths.



@C93MIN

**Set the Minimum Length (Default: 1)**



@C93MAX

**Set the Maximum Length (Default: 48)**



If minimum length is set to be greater than maximum length, the scanner only decodes Code 93 barcodes with either the minimum or maximum length. If minimum length is same as maximum length, only Code 93 barcodes with that length are to be decoded.

**Set the scanner to decode Code 93 barcodes containing between 8 and 12 characters:**

**E**  
*example*

1. Scan the **Enter Setup** barcode.
2. Scan the **Set the Minimum Length** barcode.
3. Scan the numeric barcode “8” from the “Digit Barcodes” section in Appendix.
4. Scan the **Save** barcode from the “Save/Cancel Barcodes” section in Appendix.
5. Scan the **Set the Maximum Length** barcode.
6. Scan the numeric barcodes “1” and “2” from the “Digit Barcodes” section in Appendix.
7. Scan the **Save** barcode from the “Save/Cancel Barcodes” section in Appendix.
8. Scan the **Exit Setup** barcode.



#SETUPE0  
**\*\* Exit Setup**



#SETUPE1

Enter Setup

## Check Character Verification

Check characters are optional for Code 93 and can be added as the last two characters, which are calculated values used to verify the integrity of the data.

- ◇ **Disable:** The scanner transmits Code 93 barcodes as is.
- ◇ **Do Not Transmit Check Character After Verification:** The scanner checks the integrity of all Code 93 barcodes to verify that the data complies with the check character algorithm. Barcodes passing the checks will be transmitted except the last two digits, whereas those failing them will not be transmitted.
- ◇ **Transmit Check Character After Verification:** The scanner checks the integrity of all Code 93 barcodes to verify that the data complies with the check character algorithm. Barcodes passing the checks will be transmitted, whereas those failing them will not be transmitted.



@C93CHK0

Disable



@C93CHK1

**\*\* Do Not Transmit Check Character After Verification**



@C93CHK2

**Transmit Check Character After Verification**



If the **Do Not Transmit Check Character After Verification** option is enabled, Code 93 barcodes with a length that is less than the configured minimum length after having the two check characters excluded will not be decoded. (For example, when the **Do Not Transmit Check Character After Verification** option is enabled and the minimum length is set to 4, Code 93 barcodes with a total length of 4 characters including the two check characters cannot be read.)



#SETUPE0

**\*\* Exit Setup**



#SETUPE1  
**Enter Setup**

---

## China Post 25

### Restore Factory Defaults



@CHPDEF  
**Restore the Factory Defaults of China Post 25**

### Enable/Disable China Post 25



@CHPENA1  
**Enable China Post 25**



@CHPENAO  
**\*\* Disable China Post 25**



If the scanner fails to identify China Post 25 barcodes, you may first try this solution by scanning the **Enter Setup** barcode and then **Enable China Post 25** barcode.



#SETUPE0  
**\*\* Exit Setup**



#SETUPE1

**Enter Setup**

---

## Set Length Range for China Post 25

The scanner can be configured to only decode China Post 25 barcodes with lengths that fall between (inclusive) the minimum and maximum lengths. To accomplish it, you need to set the minimum and maximum lengths.



@CHPMIN

**Set the Minimum Length (Default: 1)**



@CHPMAX

**Set the Maximum Length (Default: 48)**



If minimum length is set to be greater than maximum length, the scanner only decodes China Post 25 barcodes with either the minimum or maximum length. If minimum length is same as maximum length, only China Post 25 barcodes with that length are to be decoded.

## **E** *xample*

**Set the scanner to decode China Post 25 barcodes containing between 8 and 12 characters:**

1. Scan the **Enter Setup** barcode.
2. Scan the **Set the Minimum Length** barcode.
3. Scan the numeric barcode “8” from the “Digit Barcodes” section in Appendix.
4. Scan the **Save** barcode from the “Save/Cancel Barcodes” section in Appendix.
5. Scan the **Set the Maximum Length** barcode.
6. Scan the numeric barcodes “1” and “2” from the “Digit Barcodes” section in Appendix.
7. Scan the **Save** barcode from the “Save/Cancel Barcodes” section in Appendix.
8. Scan the **Exit Setup** barcode.

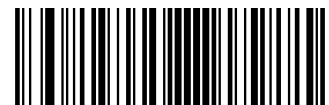

#SETUPE0

**\*\* Exit Setup**



#SETUPE1  
Enter Setup

## Check Character Verification

A check character is optional for China Post 25 and can be added as the last character. It is a calculated value used to verify the integrity of the data.

- ◇ **Disable:** The scanner transmits China Post 25 barcodes as is.
- ◇ **Do Not Transmit Check Character After Verification:** The scanner checks the integrity of all China Post 25 barcodes to verify that the data complies with the check character algorithm. Barcodes passing the check will be transmitted except the last digit, whereas those failing it will not be transmitted.
- ◇ **Transmit Check Character After Verification:** The scanner checks the integrity of all China Post 25 barcodes to verify that the data complies with the check character algorithm. Barcodes passing the check will be transmitted, whereas those failing it will not be transmitted.



@CHPCHK0  
**\*\* Disable**



@CHPCHK1

**Do Not Transmit Check Character After Verification**



@CHPCHK2

**Transmit Check Character After Verification**



If the **Do Not Transmit Check Character After Verification** option is enabled, China Post 25 barcodes with a length that is less than the configured minimum length after having the check character excluded will not be decoded. (For example, when the **Do Not Transmit Check Character After Verification** option is enabled and the minimum length is set to 4, China Post 25 barcodes with a total length of 4 characters including the check character cannot be read.)



#SETUPE0  
**\*\* Exit Setup**



#SETUPE1  
Enter Setup

---

## GS1-128 (UCC/EAN-128)

### Restore Factory Defaults



@GS1DEF

Restore the Factory Defaults of GS1-128

### Enable/Disable GS1-128



@GS1ENA1

\*\* Enable GS1-128



@GS1ENA0

Disable GS1-128



If the scanner fails to identify GS1-128 barcodes, you may first try this solution by scanning the **EnterSetup** barcode and then **Enable GS1-128** barcode.



#SETUPE0

\*\* Exit Setup



#SETUPE1  
**Enter Setup**

## Set Length Range for GS1-128

The scanner can be configured to only decode GS1-128 barcodes with lengths that fall between (inclusive) the minimum and maximum lengths. To accomplish it, you need to set the minimum and maximum lengths.



**Set the Minimum Length (Default: 1)**



**Set the Maximum Length (Default: 48)**



If minimum length is set to be greater than maximum length, the scanner only decodes GS1-128 barcodes with either the minimum or maximum length. If minimum length is same as maximum length, only GS1-128 barcodes with that length are to be decoded.

## **E** *sample*

Set the scanner to decode GS1-128 barcodes containing between 8 and 12 characters:

1. Scan the **Enter Setup** barcode.
2. Scan the **Set the Minimum Length** barcode.
3. Scan the numeric barcode “8” from the “Digit Barcodes” section in Appendix.
4. Scan the **Save** barcode from the “Save/Cancel Barcodes” section in Appendix.
5. Scan the **Set the Maximum Length** barcode.
6. Scan the numeric barcodes “1” and “2” from the “Digit Barcodes” section in Appendix.
7. Scan the **Save** barcode from the “Save/Cancel Barcodes” section in Appendix.
8. Scan the **Exit Setup** barcode.



#SETUPE0  
**\*\* Exit Setup**





#SETUPE1  
Enter Setup

## GS1 Databar (RSS)

### Restore Factory Defaults



@RSSDEF

Restore the Factory Defaults of GS1 Databar

### Enable/Disable GS1 Databar



@RSSENA1

\*\* Enable GS1 Databar

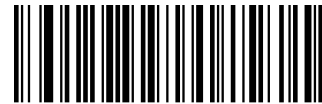

@RSSENA0

Disable GS1 Databar



If the scanner fails to identify GS1 Databar barcodes, you may first try this solution by scanning the **Enter Setup** barcode and then **Enable GS1 Databar** barcode.

### Transmit Application Identifier "01"

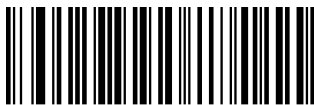

@RSSTA1

\*\* Transmit Application Identifier "01"



@RSSTA0

Do Not Transmit Application Identifier "01"



#SETUPE0  
\*\* Exit Setup



#SETUPE1  
Enter Setup

## GS1 Composite (EAN-UCC Composite)

### Restore Factory Defaults



@CPTDEF  
Restore the Factory Defaults of GS1 Composite

### Enable/Disable GS1 Composite

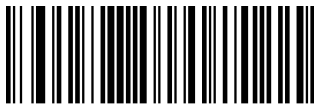

@CPTENA1  
Enable GS1 Composite



@CPTENA0  
**\*\* Disable GS1 Composite**



If the scanner fails to identify GS1 Composite barcodes, you may first try this solution by scanning the **Enter Setup** barcode and then **Enable GS1 Composite** barcode.

### Enable/Disable UPC/EAN Composite



@CPTUPC1  
Enable UPC/EAN Composite



@CPTUPC0  
**\*\* Disable UPC/EAN Composite**



#SETUPE0  
**\*\* Exit Setup**



#SETUPE1  
**Enter Setup**

---

## Code 11

### Restore Factory Defaults



@C11DEF  
**Restore the Factory Defaults of Code 11**

### Enable/Disable Code 11



@C11ENA1  
**\*\* Enable Code 11**



@C11ENA0  
**Disable Code 11**



If the scanner fails to identify Code 11 barcodes, you may first try this solution by scanning the **Enter Setup** barcode and then **Enable Code 11** barcode.

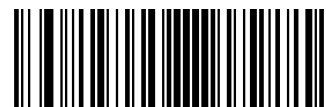

#SETUPE0  
**\*\* Exit Setup**



#SETUPE1  
**Enter Setup**

---

## Set Length Range for Code 11

The scanner can be configured to only decode Code 11 barcodes with lengths that fall between (inclusive) the minimum and maximum lengths. To accomplish it, you need to set the minimum and maximum lengths.



@C11MIN  
**Set the Minimum Length (Default: 4)**



@C11MAX  
**Set the Maximum Length (Default: 48)**



If minimum length is set to be greater than maximum length, the scanner only decodes Code 11 barcodes with either the minimum or maximum length. If minimum length is same as maximum length, only Code 11 barcodes with that length are to be decoded.



**Set the scanner to decode Code 11 barcodes containing between 8 and 12 characters:**

1. Scan the **Enter Setup** barcode.
2. Scan the **Set the Minimum Length** barcode.
3. Scan the numeric barcode “8” from the “Digit Barcodes” section in Appendix.
4. Scan the **Save** barcode from the “Save/Cancel Barcodes” section in Appendix.
5. Scan the **Set the Maximum Length** barcode.
6. Scan the numeric barcodes “1” and “2” from the “Digit Barcodes” section in Appendix.
7. Scan the **Save** barcode from the “Save/Cancel Barcodes” section in Appendix.
8. Scan the **Exit Setup** barcode.



#SETUPE0  
**\*\* Exit Setup**



#SETUPE1

Enter Setup

---

### Check Character Verification

Check characters are optional for Code 11 and can be added as the last one or two characters, which are calculated values used to verify the integrity of the data.

If the **Disable** option is enabled, the scanner transmits Code 11 barcodes as is.



@C11CHK0

Disable



@C11CHK1

\*\* One Check Character, MOD11



@C11CHK2

Two Check Characters, MOD11/MOD11



@C11CHK3

Two Check Characters, MOD11/MOD9



@C11CHK4

One Check Character, MOD11 (Len<=10)

Two Check Characters, MOD11/MOD11(Len>10)



@C11CHK5

One Check Character, MOD11 (Len<=10)

Two Check Characters, MOD11/MOD9 (Len>10)



#SETUPE0

\*\* Exit Setup



#SETUPE1  
Enter Setup

---

### Transmit Check Character



@C11TCK0  
Do Not Transmit Code 11 Check Character



@C11TCK1  
**\*\* Transmit Code 11 Check Character**



If you select a check character algorithm and the **Do Not Transmit Check Character** option, Code 11 barcodes with a length that is less than the configured minimum length after having the check character(s) excluded will not be decoded. (For example, when the **One Check Character, MOD11** and **Do Not Transmit Check Character** options are enabled and the minimum length is set to 4, Code 11 barcodes with a total length of 4 characters including the check character cannot be read.)



#SETUPE0  
**\*\* Exit Setup**



#SETUPE1  
**Enter Setup**

---

## ISBN

### Restore Factory Defaults



@ISBDEF  
**Restore the Factory Defaults of ISBN**

### Enable/Disable ISBN



@ISBENA1  
**\*\*Enable ISBN**



@ISBENA0  
**Disable ISBN**



If the scanner fails to identify ISBN barcodes, you may first try this solution by scanning the **Enter Setup** barcode and then **Enable ISBN** barcode.

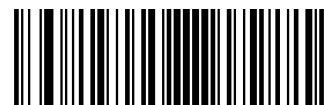

#SETUPE0  
**\*\* Exit Setup**



#SETUPE1  
**Enter Setup**

---

### Set ISBN Format



@ISBT101  
**\*\* ISBN-10**



@ISBT100  
**ISBN-13**



#SETUPE0  
**\*\* Exit Setup**





#SETUPE1  
**Enter Setup**

---

## ISSN

### Restore Factory Defaults



@ISSDEF  
**Restore the Factory Defaults of ISSN**

### Enable/Disable ISSN



@ISSENA1  
**Enable ISSN**

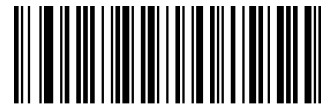

@ISSENA0  
**\*\* Disable ISSN**



If the scanner fails to identify ISSN barcodes, you may first try this solution by scanning the **Enter Setup** barcode and then **Enable ISSN** barcode.



#SETUPE0  
**\*\* Exit Setup**



#SETUPE1  
**Enter Setup**

---

## Industrial 25

### Restore Factory Defaults



@L25DEF  
**Restore the Factory Defaults of Industrial 25**

### Enable/Disable Industrial 25



@L25ENA1  
**\*\* Enable Industrial 25**



@L25ENA0  
**Disable Industrial 25**



If the scanner fails to identify Industrial 25 barcodes, you may first try this solution by scanning the **Enter Setup** barcode and then **Enable Industrial 25** barcode.



#SETUPE0  
**\*\* Exit Setup**



#SETUPE1

**Enter Setup**

---

## Set Length Range for Industrial 25

The scanner can be configured to only decode Industrial 25 barcodes with lengths that fall between (inclusive) the minimum and maximum lengths. To accomplish it, you need to set the minimum and maximum lengths.



@L25MIN

**Set the Minimum Length (Default: 6)**



@L25MAX

**Set the Maximum Length (Default: 48)**



If minimum length is set to be greater than maximum length, the scanner only decodes Industrial 25 barcodes with either the minimum or maximum length. If minimum length is same as maximum length, only Industrial 25 barcodes with that length are to be decoded.

**E**  
*sample*

**Set the scanner to decode Industrial 25 barcodes containing between 8 and 12 characters:**

1. Scan the **Enter Setup** barcode.
2. Scan the **Set the Minimum Length** barcode.
3. Scan the numeric barcode “8” from the “Digit Barcodes” section in Appendix.
4. Scan the **Save** barcode from the “Save/Cancel Barcodes” section in Appendix.
5. Scan the **Set the Maximum Length** barcode.
6. Scan the numeric barcodes “1” and “2” from the “Digit Barcodes” section in Appendix.
7. Scan the **Save** barcode from the “Save/Cancel Barcodes” section in Appendix.
8. Scan the **Exit Setup** barcode.



#SETUPE0

**\*\* Exit Setup**



#SETUPE1  
Enter Setup

## Check Character Verification

A check character is optional for Industrial 25 and can be added as the last character. It is a calculated value used to verify the integrity of the data.

- ◇ **Disable:** The scanner transmits Industrial 25 barcodes as is.
- ◇ **Do Not Transmit Check Character After Verification:** The scanner checks the integrity of all Industrial 25 barcodes to verify that the data complies with the check character algorithm. Barcodes passing the check will be transmitted except the last digit, whereas those failing it will not be transmitted.
- ◇ **Transmit Check Character After Verification:** The scanner checks the integrity of all Industrial 25 barcodes to verify that the data complies with the check character algorithm. Barcodes passing the check will be transmitted, whereas those failing it will not be transmitted.



@L25CHK0  
\*\* Disable

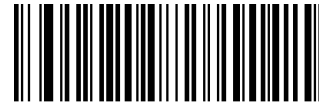

**Do Not Transmit Check Character After Verification**



**Transmit Check Character After Verification**



If the **Do Not Transmit Check Character After Verification** option is enabled, Industrial 25 barcodes with a length that is less than the configured minimum length after having the check character excluded will not be decoded. (For example, when the **Do Not Transmit Check Character After Verification** option is enabled and the minimum length is set to 4, Industrial 25 barcodes with a total length of 4 characters including the check character cannot be read.)



#SETUPE0  
\*\* Exit Setup



#SETUPE1  
**Enter Setup**

---

## Standard 25

### Restore Factory Defaults



@S25DEF  
**Restore the Factory Defaults of Standard 25**

### Enable/Disable Standard 25



@S25ENA1  
**\*\* Enable Standard 25**



@S25ENA0  
**Disable Standard 25**



If the scanner fails to identify Standard 25 barcodes, you may first try this solution by scanning the **Enter Setup** barcode and then **Enable Standard 25** barcode.



#SETUPE0  
**\*\* Exit Setup**



#SETUPE1  
Enter Setup

## Set Length Range for Standard 25

The scanner can be configured to only decode Standard 25 barcodes with lengths that fall between (inclusive) the minimum and maximum lengths. To accomplish it, you need to set the minimum and maximum lengths.



@S25MIN  
Set the Minimum Length (Default: 6)



@S25MAX  
Set the Maximum Length (Default: 48)



If minimum length is set to be greater than maximum length, the scanner only decodes Standard 25 barcodes with either the minimum or maximum length. If minimum length is same as maximum length, only Standard 25 barcodes with that length are to be decoded.



**Set the scanner to decode Standard 25 barcodes containing between 8 and 12 characters:**

1. Scan the **Enter Setup** barcode.
2. Scan the **Set the Minimum Length** barcode.
3. Scan the numeric barcode “8” from the “Digit Barcodes” section in Appendix.
4. Scan the **Save** barcode from the “Save/Cancel Barcodes” section in Appendix.
5. Scan the **Set the Maximum Length** barcode.
6. Scan the numeric barcodes “1” and “2” from the “Digit Barcodes” section in Appendix.
7. Scan the **Save** barcode from the “Save/Cancel Barcodes” section in Appendix.
8. Scan the **Exit Setup** barcode.



#SETUPE0  
\*\* Exit Setup



#SETUPE1

Enter Setup

## Check Character Verification

A check character is optional for Standard 25 and can be added as the last character. It is a calculated value used to verify the integrity of the data.

- ◇ **Disable:** The scanner transmits Standard 25 barcodes as is.
- ◇ **Do Not Transmit Check Character After Verification:** The scanner checks the integrity of all Standard 25 barcodes to verify that the data complies with the check character algorithm. Barcodes passing the check will be transmitted except the last digit, whereas those failing it will not be transmitted.
- ◇ **Transmit Check Character After Verification:** The scanner checks the integrity of all Standard 25 barcodes to verify that the data complies with the check character algorithm. Barcodes passing the check will be transmitted, whereas those failing it will not be transmitted.



@S25CHK0

\*\* Disable



@S25CHK1

Do Not Transmit Check Character After Verification



@S25CHK2

Transmit Check Character After Verification



If the **Do Not Transmit Check Character After Verification** option is enabled, Standard 25 barcodes with a length that is less than the configured minimum length after having the check character excluded will not be decoded. (For example, when the **Do Not Transmit Check Character After Verification** option is enabled and the minimum length is set to 4, Standard 25 barcodes with a total length of 4 characters including the check character cannot be read.)



#SETUPE0

\*\* Exit Setup



#SETUPE1  
**Enter Setup**

---

## Plessey

### Restore Factory Defaults



@PLYDEF  
**Restore the Factory Defaults of Plessey**

### Enable/Disable Plessey



@PLYENA1  
**Enable Plessey**



@PLYENA0  
**\*\* Disable Plessey**



If the scanner fails to identify Plessey barcodes, you may first try this solution by scanning the **Enter Setup** barcode and then **Enable Plessey** barcode.



#SETUPE0  
**\*\* Exit Setup**





#SETUPE1

**Enter Setup**

---

## Set Length Range for Plessey

The scanner can be configured to only decode Plessey barcodes with lengths that fall between (inclusive) the minimum and maximum lengths. To accomplish it, you need to set the minimum and maximum lengths.



@PLYMIN

**Set the Minimum Length (Default: 48)**



@PLYMAX

**Set the Maximum Length (Default: 4)**



If minimum length is set to be greater than maximum length, the scanner only decodes Plessey barcodes with either the minimum or maximum length. If minimum length is same as maximum length, only Plessey barcodes with that length are to be decoded.

**Set the scanner to decode Plessey barcodes containing between 8 and 12 characters:**

**E**  
*xample*

1. Scan the **Enter Setup** barcode.
2. Scan the **Set the Minimum Length** barcode.
3. Scan the numeric barcode “8” from the “Digit Barcodes” section in Appendix.
4. Scan the **Save** barcode from the “Save/Cancel Barcodes” section in Appendix.
5. Scan the **Set the Maximum Length** barcode.
6. Scan the numeric barcodes “1” and “2” from the “Digit Barcodes” section in Appendix.
7. Scan the **Save** barcode from the “Save/Cancel Barcodes” section in Appendix.
8. Scan the **Exit Setup** barcode.



#SETUPE0

**\*\* Exit Setup**



#SETUPE1  
Enter Setup

## Check Character Verification

Check characters are optional for Plessey and can be added as the last two characters, which are calculated values used to verify the integrity of the data.

- ◇ **Disable:** The scanner transmits Plessey barcodes as is.
- ◇ **Do Not Transmit Check Character After Verification:** The scanner checks the integrity of all Plessey barcodes to verify that the data complies with the check character algorithm. Barcodes passing the checks will be transmitted except the last two digits, whereas those failing them will not be transmitted.
- ◇ **Transmit Check Character After Verification:** The scanner checks the integrity of all Plessey barcodes to verify that the data complies with the check character algorithm. Barcodes passing the checks will be transmitted, whereas those failing them will not be transmitted.



@PLYCHK0  
\*\* Disable

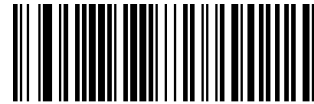

**Do Not Transmit Check Character After Verification**



**Transmit Check Character After Verification**



If the **Do Not Transmit Check Character After Verification** option is enabled, Plessey barcodes with a length that is less than the configured minimum length after having the check characters excluded will not be decoded. (For example, when the **Do Not Transmit Check Character After Verification** option is enabled and the minimum length is set to 4, Plessey barcodes with a total length of 4 characters including the check characters cannot be read.)



#SETUPE0  
\*\* Exit Setup



#SETUPE1  
**Enter Setup**

---

## MSI-Plessey

### Restore Factory Defaults



@MSIDF  
**Restore the Factory Defaults of MSI-Plessey**

### Enable/Disable MSI-Plessey



@MSIENA1  
**Enable MSI-Plessey**



@MSIENA0  
**\*\* Disable MSI-Plessey**



If the scanner fails to identify MSI-Plessey barcodes, you may first try this solution by scanning the **Enter Setup** barcode and then **Enable MSI-Plessey** barcode.



#SETUPE0  
**\*\* Exit Setup**



#SETUPE1  
**Enter Setup**

## Set Length Range for MSI-Plessey

The scanner can be configured to only decode MSI-Plessey barcodes with lengths that fall between (inclusive) the minimum and maximum lengths. To accomplish it, you need to set the minimum and maximum lengths.



**Set the Minimum Length (Default: 4)**



**Set the Maximum Length (Default: 48)**



If minimum length is set to be greater than maximum length, the scanner only decodes MSI-Plessey barcodes with either the minimum or maximum length. If minimum length is same as maximum length, only MSI-Plessey barcodes with that length are to be decoded.

**E**  
*sample*

**Set the scanner to decode MSI-Plessey barcodes containing between 8 and 12 characters:**

1. Scan the **Enter Setup** barcode.
2. Scan the **Set the Minimum Length** barcode.
3. Scan the numeric barcode “8” from the “Digit Barcodes” section in Appendix.
4. Scan the **Save** barcode from the “Save/Cancel Barcodes” section in Appendix.
5. Scan the **Set the Maximum Length** barcode.
6. Scan the numeric barcodes “1” and “2” from the “Digit Barcodes” section in Appendix.
7. Scan the **Save** barcode from the “Save/Cancel Barcodes” section in Appendix.
8. Scan the **Exit Setup** barcode.



#SETUPE0  
**\*\* Exit Setup**



#SETUPE1  
**Enter Setup**

---

## Check Character Verification

Check characters are optional for MSI-Plessey and can be added as the last one or two characters, which are calculated values used to verify the integrity of the data.

If the **Disable** option is enabled, the scanner transmits MSI-Plessey barcodes as is.



@MSICLK0  
**Disable**



@MSICLK1  
**\*\* One Check Character, MOD10**



@MSICLK2  
**Two Check Characters, MOD10/MOD10**



@MSICLK3  
**Two Check Characters, MOD10/MOD11**



#SETUPE0  
**\*\* Exit Setup**



#SETUPE1  
Enter Setup

---

### Transmit Check Character



@MSITCK1

\*\* Transmit MSI-Plessey Check Character



@MSITCK0

Do Not Transmit MSI-Plessey Check Character



If you select a check character algorithm and the **Do Not Transmit Check Character** option, MSI-Plessey barcodes with a length that is less than the configured minimum length after having the check character(s) excluded will not be decoded. (For example, when the **One Check Character, MOD10** and **Do Not Transmit Check Character** options are enabled and the minimum length is set to 4, MSI-Plessey barcodes with a total length of 4 characters including the check character cannot be read.)



#SETUPE0  
\*\* Exit Setup



#SETUPE1  
**Enter Setup**

---

## AIM 128

### Restore Factory Defaults



@AIMDEF  
**Restore the Factory Defaults of AIM 128**

### Enable/Disable AIM 128



@AIMENA1  
**\*\* Enable AIM 128**



@AIMENA0  
**Disable AIM 128**



If the scanner fails to identify AIM 128 barcodes, you may first try this solution by scanning the **Enter Setup** barcode and then **Enable AIM 128** barcode.



#SETUPE0  
**\*\* Exit Setup**



#SETUPE1  
**Enter Setup**

## Set Length Range for AIM 128

The scanner can be configured to only decode AIM 128 barcodes with lengths that fall between (inclusive) the minimum and maximum lengths. To accomplish it, you need to set the minimum and maximum lengths.



**Set the Minimum Length (Default: 1)**



**Set the Maximum Length (Default: 48)**



If minimum length is set to be greater than maximum length, the scanner only decodes AIM 128 barcodes with either the minimum or maximum length. If minimum length is same as maximum length, only AIM 128 barcodes with that length are to be decoded.



**Set the scanner to decode AIM 128 barcodes containing between 8 and 12 characters:**

1. Scan the **Enter Setup** barcode.
2. Scan the **Set the Minimum Length** barcode.
3. Scan the numeric barcode “8” from the “Digit Barcodes” section in Appendix.
4. Scan the **Save** barcode from the “Save/Cancel Barcodes” section in Appendix.
5. Scan the **Set the Maximum Length** barcode.
6. Scan the numeric barcodes “1” and “2” from the “Digit Barcodes” section in Appendix.
7. Scan the **Save** barcode from the “Save/Cancel Barcodes” section in Appendix.
8. Scan the **Exit Setup** barcode.



#SETUPE0  
**\*\* Exit Setup**





#SETUPE1  
**Enter Setup**

---

## ISBT 128

### Restore Factory Defaults



@IBTDEF  
**Restore the Factory Defaults of ISBT 128**

### Enable/Disable ISBT 128



@IBTENA1  
**Enable ISBT 128**

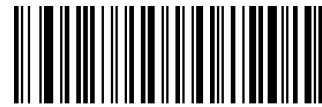

@IBTENA0  
**\*\* Disable ISBT 128**



If the scanner fails to identify ISBT 128 barcodes, you may first try this solution by scanning the **Enter Setup** barcode and then **Enable ISBT 128** barcode.



#SETUPE0  
**\*\* Exit Setup**



#SETUPE1  
**Enter Setup**

---

## Code 49

### Restore Factory Defaults



@C49DEF  
**Restore the Factory Defaults of AIM 49**

### Enable/Disable AIM 49



@C49ENA1  
**\*\* Enable AIM 49**



@C49ENA0  
**Disable AIM 49**



If the scanner fails to identify Code 49 barcodes, you may first try this solution by scanning the **Enter Setup** barcode and then **Enable AIM 49** barcode.



#SETUPE0  
**\*\* Exit Setup**



#SETUPE1

**Enter Setup**

---

## Set Length Range for Code 49

The scanner can be configured to only decode Code 49 barcodes with lengths that fall between (inclusive) the minimum and maximum lengths. To accomplish it, you need to set the minimum and maximum lengths.



@C49MIN

**Set the Minimum Length (Default: 1)**



@C49MAX

**Set the Maximum Length (Default: 80)**



If minimum length is set to be greater than maximum length, the scanner only decodes Code 49 barcodes with either the minimum or maximum length. If minimum length is same as maximum length, only Code 49 barcodes with that length are to be decoded.

**E**  
*xample*

**Set the scanner to decode Code 49 barcodes containing between 8 and 12 characters:**

1. Scan the **Enter Setup** barcode.
2. Scan the **Set the Minimum Length** barcode.
3. Scan the numeric barcode “8” from the “Digit Barcodes” section in Appendix.
4. Scan the **Save** barcode from the “Save/Cancel Barcodes” section in Appendix.
5. Scan the **Set the Maximum Length** barcode.
6. Scan the numeric barcodes “1” and “2” from the “Digit Barcodes” section in Appendix.
7. Scan the **Save** barcode from the “Save/Cancel Barcodes” section in Appendix.
8. Scan the **Exit Setup** barcode.



#SETUPE0

**\*\* Exit Setup**



#SETUPE1  
Enter Setup

## Code 16K

### Restore Factory Defaults



@16KDEF  
Restore the Factory Defaults of Code 16K

### Enable/Disable AIM 49



@16KENA1  
\*\* Enable Code 16K



@16KENA0  
Disable Code 16K



If the scanner fails to identify Code 16K barcodes, you may first try this solution by scanning the **Enter Setup** barcode and then **Enable Code 16K** barcode.



#SETUPE0  
\*\* Exit Setup



#SETUPE1

**Enter Setup**

## Set Length Range for Code 16K

The scanner can be configured to only decode Code 16K barcodes with lengths that fall between (inclusive) the minimum and maximum lengths. To accomplish it, you need to set the minimum and maximum lengths.



@16KMIN

**Set the Minimum Length (Default: 1)**



@16KMAX

**Set the Maximum Length (Default: 80)**



If minimum length is set to be greater than maximum length, the scanner only decodes Code 16K barcodes with either the minimum or maximum length. If minimum length is same as maximum length, only Code 16K barcodes with that length are to be decoded.



**Set the scanner to decode Code 16K barcodes containing between 8 and 12 characters:**

1. Scan the **Enter Setup** barcode.
2. Scan the **Set the Minimum Length** barcode.
3. Scan the numeric barcode “8” from the “Digit Barcodes” section in Appendix.
4. Scan the **Save** barcode from the “Save/Cancel Barcodes” section in Appendix.
5. Scan the **Set the Maximum Length** barcode.
6. Scan the numeric barcodes “1” and “2” from the “Digit Barcodes” section in Appendix.
7. Scan the **Save** barcode from the “Save/Cancel Barcodes” section in Appendix.
8. Scan the **Exit Setup** barcode.



#SETUPE0

**\*\* Exit Setup**



#SETUPE1  
**Enter Setup**

---

## PDF417

### Restore Factory Defaults



@PDFDEF  
**Restore the Factory Defaults of PDF417**

### Enable/Disable PDF417



@PDFENA1  
**\*\* Enable PDF417**



@PDFENA0  
**Disable PDF417**



If the scanner fails to identify PDF417 barcodes, you may first try this solution by scanning the **Enter Setup** barcode and then **Enable PDF417** barcode.



#SETUPE0  
**\*\* Exit Setup**



#SETUPE1

**Enter Setup**

---

## Set Length Range for PDF417

The scanner can be configured to only decode PDF417 barcodes with lengths that fall between (inclusive) the minimum and maximum lengths. To accomplish it, you need to set the minimum and maximum lengths.



@PDFMIN

**Set the Minimum Length (Default: 1)**



@PDFMAX

**Set the Maximum Length (Default: 2710)**



Minimum length is not allowed to be greater than maximum length. If you only want to read PDF417 barcodes with a specific length, set both minimum and maximum lengths to be that desired length.

**Set the scanner to decode PDF417 barcodes containing between 8 and 12 characters:**

**E**  
*xample*

1. Scan the **Enter Setup** barcode.
2. Scan the **Set the Minimum Length** barcode.
3. Scan the numeric barcode “8” from the “Digit Barcodes” section in Appendix.
4. Scan the **Save** barcode from the “Save/Cancel Barcodes” section in Appendix.
5. Scan the **Set the Maximum Length** barcode.
6. Scan the numeric barcodes “1” and “2” from the “Digit Barcodes” section in Appendix.
7. Scan the **Save** barcode from the “Save/Cancel Barcodes” section in Appendix.
8. Scan the **Exit Setup** barcode.



#SETUPE0

**\*\* Exit Setup**



#SETUPE1  
**Enter Setup**

---

## PDF417 Twin Code

PDF417 twin code is 2 PDF417 barcodes paralleled vertically or horizontally. They must both be either regular or inverse barcodes. They must have similar specifications and be placed closely together.

There are 3 options for reading PDF417 twin codes:

- ◇ **Single PDF417 Only:** Read either PDF417 code.
- ◇ **Twin PDF417 Only:** Read both PDF417 codes.
- ◇ **Both Single & Twin:** Read both PDF417 codes. If successful, transmit as twin PDF417 only. Otherwise, try single PDF417 only.



@PDFDOU0  
**\*\* Single PDF417 Only**



@PDFDOU1  
**Twin PDF417 Only**



@PDFDOU2  
**Both Single & Twin**



#SETUPE0  
**\*\* Exit Setup**





#SETUPE1

Enter Setup

---

### PDF417 Inverse

Regular barcode: Dark bars on a bright background.

Inverse barcode: Bright bars on a dark background.



@PDFINV0

**\*\* Decode Regular PDF417 Barcodes Only**



@PDFINV1

**Decode Inverse PDF417 Barcodes Only**

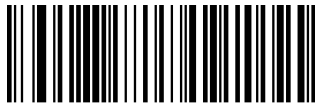

@PDFINV2

**Decode Both**

### Character Encoding



@PDFENC0

**\*\* Default Character Encoding**

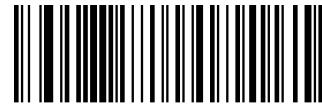

@PDFENC1

**UTF-8**



@PDFENC2

**Automatically select UTF-8 or Code Page**



#SETUPE0

**\*\* Exit Setup**



#SETUPE1  
**Enter Setup**

---

## PDF417 ECI Output



@PDFECI0  
**Disable PDF417 ECI Output**



@PDFECI1  
**\*\* Enable PDF417 ECI Output**



#SETUPE0  
**\*\* Exit Setup**



#SETUPE1  
**Enter Setup**

---

## Micro PDF417

### Restore Factory Defaults



@MPDDEF  
**Restore the Factory Defaults of Micro PDF417**

### Enable/Disable Micro PDF417



@MPDENA1  
**Enable Micro PDF417**



@MPDENA0  
**\*\* Disable Micro PDF417**



If the scanner fails to identify Micro PDF417 barcodes, you may first try this solution by scanning the **Enter Setup** barcode and then **Enable Micro PDF417** barcode.



#SETUPE0  
**\*\* Exit Setup**



#SETUPE1  
**Enter Setup**

## Set Length Range for Micro PDF417

The scanner can be configured to only decode Micro PDF417 barcodes with lengths that fall between (inclusive) the minimum and maximum lengths. To accomplish it, you need to set the minimum and maximum lengths.



**Set the Minimum Length (Default: 1)**



**Set the Maximum Length (Default: 366)**



Minimum length is not allowed to be greater than maximum length. If you only want to read Micro PDF417 barcodes with a specific length, set both minimum and maximum lengths to be that desired length.

**E**  
*xample*

**Set the scanner to decode Micro PDF417 barcodes containing between 8 and 12 characters:**

1. Scan the **Enter Setup** barcode.
2. Scan the **Set the Minimum Length** barcode.
3. Scan the numeric barcode “8” from the “Digit Barcodes” section in Appendix.
4. Scan the **Save** barcode from the “Save/Cancel Barcodes” section in Appendix.
5. Scan the **Set the Maximum Length** barcode.
6. Scan the numeric barcodes “1” and “2” from the “Digit Barcodes” section in Appendix.
7. Scan the **Save** barcode from the “Save/Cancel Barcodes” section in Appendix.
8. Scan the **Exit Setup** barcode.



#SETUPE0  
**\*\* Exit Setup**



#SETUPE1  
**Enter Setup**

---

## QR Code

### Restore Factory Defaults



@QRCDEF  
**Restore the Factory Defaults of QR Code**

### Enable/Disable QR Code



@QRCENA1  
**\*\* Enable QR Code**



@QRCENA0  
**Disable QR Code**



If the scanner fails to identify QR Code barcodes, you may first try this solution by scanning the **Enter Setup** barcode and then **Enable QR Code** barcode.



#SETUPE1  
**Enter Setup**



#SETUPE1  
**Enter Setup**

---

## Set Length Range for QR Code

The scanner can be configured to only decode QR Code barcodes with lengths that fall between (inclusive) the minimum and maximum lengths. To accomplish it, you need to set the minimum and maximum lengths.



@QRCPMIN

**Set the Minimum Length (Default: 1)**



@QRCPMAX

**Set the Maximum Length (Default: 7089)**



Minimum length is not allowed to be greater than maximum length. If you only want to read QR Code barcodes with a specific length, set both minimum and maximum lengths to be that desired length.

**E**  
*example*

**Set the scanner to decode QR Code barcodes containing between 8 and 12 characters:**

1. Scan the **Enter Setup** barcode.
2. Scan the **Set the Minimum Length** barcode.
3. Scan the numeric barcode “8” from the “Digit Barcodes” section in Appendix.
4. Scan the **Save** barcode from the “Save/Cancel Barcodes” section in Appendix.
5. Scan the **Set the Maximum Length** barcode.
6. Scan the numeric barcodes “1” and “2” from the “Digit Barcodes” section in Appendix.
7. Scan the **Save** barcode from the “Save/Cancel Barcodes” section in Appendix.
8. Scan the **Exit Setup** barcode.

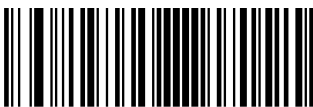

#SETUPE1  
**Enter Setup**



#SETUPE1

Enter Setup

---

## QR Twin Code

QR twin code is 2 QR barcodes paralleled vertically or horizontally. They must both be either regular or inverse barcodes. They must have similar specifications and be placed closely together.

There are 3 options for reading QR twin codes:

- ◇ **Single QR Only:** Read either QR code.
- ◇ **Twin QR Only:** Read both QR codes. Transmission sequence: left (upper) QR code followed by right (lower) QR code.
- ◇ **Both Single & Twin:** Read both QR codes. If successful, transmit as twin QR only. Otherwise, try single QR only.



@QRCDU0

**\*\* Single QR Only**



@QRCDU1

**Twin QR Only**



@QRCDU2

**Both Single & Twin**



#SETUPE1

Enter Setup



#SETUPE1  
Enter Setup

---

## QR Inverse

Regular barcode: Dark bars on a bright background.

Inverse barcode: Bright bars on a dark background.



@QRCINV0

**\*\* Decode Regular QR Barcodes Only**

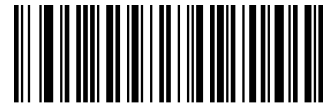

@QRCINV1

**Decode Inverse QR Barcodes Only**



@QRCINV2

**Decode Both**

## Character Encoding



@QRCENC0

**\*\* Default Character Encoding**



@QRCENC1

**UTF-8**



@QRCENC3

**Automatically select UTF-8 or Code Page**



#SETUPE1  
Enter Setup





#SETUPE1  
Enter Setup

---

## QR ECI Output



@QRCEC10  
Disable QR ECI Output



@QRCEC11  
\*\* Enable QR ECI Output

## Website QR Code

Website QR is the QR code starts with “http” or “HTTP”



@QRCURL0  
Disable



@QRCURL1  
\*\*Enable



#SETUPE1  
Enter Setup



#SETUPE1  
**Enter Setup**

---

## Micro QR Code

### Restore Factory Defaults



@MQRDEF  
**Restore the Factory Defaults of Micro QR**

### Enable/Disable Micro QR



@MQRENA1  
**\*\* Enable Micro QR**



@MQRENA0  
**Disable Micro QR**



If the scanner fails to identify Micro QR barcodes, you may first try this solution by scanning the **Enter Setup** barcode and then **Enable Micro QR** barcode.

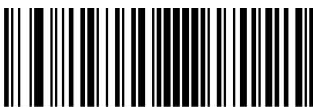

#SETUPE1  
**Enter Setup**



#SETUPE1

Enter Setup

---

## Set Length Range for Micro QR

The scanner can be configured to only decode Micro QR barcodes with lengths that fall between (inclusive) the minimum and maximum lengths. To accomplish it, you need to set the minimum and maximum lengths.



@MQRMIN

Set the Minimum Length (Default: 1)



@MQRMAX

Set the Maximum Length (Default: 35)



Minimum length is not allowed to be greater than maximum length. If you only want to read Micro QR barcodes with a specific length, set both minimum and maximum lengths to be that desired length.

**E**  
*sample*

**Set the scanner to decode Micro QR Code barcodes containing between 8 and 12 characters:**

1. Scan the **Enter Setup** barcode.
2. Scan the **Set the Minimum Length** barcode.
3. Scan the numeric barcode “8” from the “Digit Barcodes” section in Appendix.
4. Scan the **Save** barcode from the “Save/Cancel Barcodes” section in Appendix.
5. Scan the **Set the Maximum Length** barcode.
6. Scan the numeric barcodes “1” and “2” from the “Digit Barcodes” section in Appendix.
7. Scan the **Save** barcode from the “Save/Cancel Barcodes” section in Appendix.
8. Scan the **Exit Setup** barcode.



#SETUPE1

Enter Setup



#SETUPE1  
**Enter Setup**

---

## Aztec

### Restore Factory Defaults



@AZTDEF  
**Restore the Factory Defaults of Aztec Code**

### Enable/Disable Aztec Code



@AZTENA1  
**Enable Aztec Code**



@AZTENA0  
**\*\* Disable Aztec Code**



If the scanner fails to identify Aztec Code barcodes, you may first try this solution by scanning the **Enter Setup** barcode and then **Enable Aztec Code** barcode.

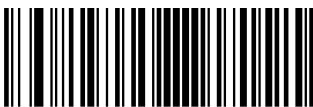

#SETUPE1  
**Enter Setup**



#SETUPE1

Enter Setup

---

## Set Length Range for Aztec Code

The scanner can be configured to only decode Aztec barcodes with lengths that fall between (inclusive) the minimum and maximum lengths. To accomplish it, you need to set the minimum and maximum lengths.



@AZTMIN

Set the Minimum Length (Default: 1)



@AZTMAX

Set the Maximum Length (Default: 3832)



Minimum length is not allowed to be greater than maximum length. If you only want to read Aztec barcodes with a specific length, set both minimum and maximum lengths to be that desired length.

**E**  
*xample*

Set the scanner to decode Aztec barcodes containing between 8 and 12 characters:

1. Scan the **Enter Setup** barcode.
2. Scan the **Set the Minimum Length** barcode.
3. Scan the numeric barcode “8” from the “Digit Barcodes” section in Appendix.
4. Scan the **Save** barcode from the “Save/Cancel Barcodes” section in Appendix.
5. Scan the **Set the Maximum Length** barcode.
6. Scan the numeric barcodes “1” and “2” from the “Digit Barcodes” section in Appendix.
7. Scan the **Save** barcode from the “Save/Cancel Barcodes” section in Appendix.
8. Scan the **Exit Setup** barcode.



#SETUPE1

Enter Setup



#SETUPE1  
**Enter Setup**

---

## Read Multi-barcodes on an Image

There are three options:

- ◇ **Mode 1:** Read one barcode only.
- ◇ **Mode 2:** Read fixed number of barcodes only.
- ◇ **Mode 3:** Composite Reading. Read fixed number of barcodes first. If unsuccessful, read one barcode only.



@AZTMOD1  
**\*\* Mode 1**



@AZTMOD2  
**Mode 2**



@AZTMOD3  
**Mode 3**



#SETUPE1  
**Enter Setup**



#SETUPE1  
Enter Setup

---

### Set the Number of Barcodes



@AZTMUL1  
\*\* 1



@AZTMUL3  
3



@AZTMUL5  
5



@AZTMUL7  
7



@AZTMUL2  
2



@AZTMUL4  
4



@AZTMUL6  
6



@AZTMUL8  
8

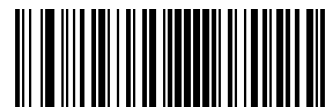

#SETUPE1  
Enter Setup



#SETUPE1  
**Enter Setup**

---

### **Aztec Inverse**

Regular barcode: Dark bars on a bright background. Inverse barcode: Bright bars on a dark background.



@AZTINV0

**\*\* Decode Regular Aztec Barcodes Only**



@AZTINV1

**Decode Inverse Aztec Barcodes Only**



@AZTINV2

**Decode Both**

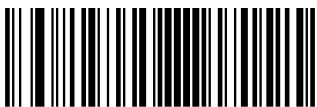

#SETUPE1  
**Enter Setup**





#SETUPE1  
Enter Setup

---

## Character Encoding



@AZTENC0  
**\*\* Default Character Encoding**

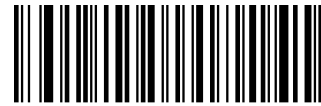

@AZTENC1  
**UTF-8**



@AZTENC2  
**Automatically select UTF-8 or Code Page**

## Aztec ECI Output



@AZTECI0  
**Disable Aztec ECI Output**



@AZTECI1  
**\*\* Enable Aztec ECI Output**



#SETUPE1  
Enter Setup



#SETUPE1  
**Enter Setup**

---

## Data Matrix

### Restore Factory Defaults



@DMCDEF  
**Restore the Factory Defaults of Data Matrix**

### Enable/Disable Data Matrix



@DMCENA1  
**\*\* Enable Data Matrix**



@DMCENA0  
**Disable Data Matrix**



If the scanner fails to identify Data Matrix barcodes, you may first try this solution by scanning the **Enter Setup** barcode and then **Enable Data Matrix** barcode.



#SETUPE1  
**Enter Setup**



#SETUPE1

**Enter Setup**

---

## Set Length Range for Data Matrix

The scanner can be configured to only decode Data Matrix barcodes with lengths that fall between (inclusive) the minimum and maximum lengths. To accomplish it, you need to set the minimum and maximum lengths.



@DMCMIN

**Set the Minimum Length (Default: 1)**



@DMCMAX

**Set the Maximum Length (Default: 3116)**



Minimum length is not allowed to be greater than maximum length. If you only want to read Data Matrix barcodes with a specific length, set both minimum and maximum lengths to be that desired length.

## **E** *sample*

**Set the scanner to decode Data Matrix barcodes containing between 8 and 12 characters:**

1. Scan the **Enter Setup** barcode.
2. Scan the **Set the Minimum Length** barcode.
3. Scan the numeric barcode “8” from the “Digit Barcodes” section in Appendix.
4. Scan the **Save** barcode from the “Save/Cancel Barcodes” section in Appendix.
5. Scan the **Set the Maximum Length** barcode.
6. Scan the numeric barcodes “1” and “2” from the “Digit Barcodes” section in Appendix.
7. Scan the **Save** barcode from the “Save/Cancel Barcodes” section in Appendix.
8. Scan the **Exit Setup** barcode.



#SETUPE1

**Enter Setup**



#SETUPE1  
**Enter Setup**

---

## Data Matrix Twin Code

Data Matrix twin code is 2 Data Matrix barcodes paralleled vertically or horizontally. They must both be either regular or inverse barcodes. They must have similar specifications and be placed closely together.

There are 3 options for reading Data Matrix twin codes:

- ◇ **Single Data Matrix Only:** Read either Data Matrix code.
- ◇ **Twin Data Matrix Only:** Read both Data Matrix codes. Transmission sequence: left (upper) Data Matrix code followed by right (lower) Data Matrix code.
- ◇ **Both Single & Twin:** Read both Data Matrix codes. If successful, transmit as twin Data Matrix only. Otherwise, try single Data Matrix only.



@DMCDOU0  
**\*\* Single Data Matrix Only**



@DMCDOU1  
**Twin Data Matrix Only**



@DMCDOU2  
**Both Single & Twin**



#SETUPE1  
**Enter Setup**



#SETUPE1

Enter Setup

---

## Rectangular Barcode

Data Matrix has two formats:

Square barcodes having the same amount of modules in length and width: 10\*10, 12\*12.... 144\*144.

Rectangular barcodes having different amounts of models in length and width: 6\*16, 6\*14...14\*22.



@DMCREC1

**\*\* Enable Rectangular Barcode**



@DMCREC0

**Disable Rectangular Barcode**

## Data Matrix Inverse

Regular barcode: Dark bars on a bright background.

Inverse barcode: Bright bars on a dark background.



@DMCINV0

**\*\* Decode Regular Data Matrix Barcodes Only**



@DMCINV1

**Decode Inverse Data Matrix Barcodes Only**



@DMCINV2

**Decode Both**



#SETUPE1

Enter Setup



#SETUPE1  
Enter Setup

---

## Character Encoding



@DMCENC0  
**\*\* Default Character Encoding**



@DMCENC1  
**UTF-8**

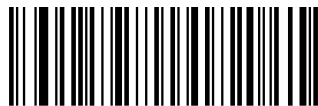

@DMCENC2  
**Automatically select UTF-8 or Code Page**

## Data Matrix ECI Output



@DMCEC10  
**Disable Data Matrix ECI Output**



@DMCEC11  
**\*\* Enable Data Matrix ECI Output**



#SETUPE1  
Enter Setup



#SETUPE1  
**Enter Setup**

---

## Maxicode

### Restore Factory Defaults



@MXCDEF  
**Restore the Factory Defaults of Maxicode**

### Enable/Disable Maxicode



@MXCENA1  
**Enable Maxicode**



@MXCENA0  
**\*\* Disable Maxicode**



If the scanner fails to identify Maxicode barcodes, you may first try this solution by scanning the **Enter Setup** barcode and then **Enable Maxicode** barcode.



#SETUPE1  
**Enter Setup**



#SETUPE1  
**Enter Setup**

## Set Length Range for Maxicode

The scanner can be configured to only decode Maxicode barcodes with lengths that fall between (inclusive) the minimum and maximum lengths. To accomplish it, you need to set the minimum and maximum lengths.



@MXCMIN  
**Set the Minimum Length (Default: 1)**



@MXCMAX  
**Set the Maximum Length (Default:150)**



Minimum length is not allowed to be greater than maximum length. If you only want to read Maxicode barcodes with a specific length, set both minimum and maximum lengths to be that desired length.

## **E** *sample*

**Set the scanner to decode Maxicode barcodes containing between 8 and 12 characters:**

1. Scan the **Enter Setup** barcode.
2. Scan the **Set the Minimum Length** barcode.
3. Scan the numeric barcode “8” from the “Digit Barcodes” section in Appendix.
4. Scan the **Save** barcode from the “Save/Cancel Barcodes” section in Appendix.
5. Scan the **Set the Maximum Length** barcode.
6. Scan the numeric barcodes “1” and “2” from the “Digit Barcodes” section in Appendix.
7. Scan the **Save** barcode from the “Save/Cancel Barcodes” section in Appendix.
8. Scan the **Exit Setup** barcode.



#SETUPE1  
**Enter Setup**





#SETUPE1  
**Enter Setup**

---

## Chinese Sensible Code

### Restore Factory Defaults



@CSCDEF

**Restore the Factory Defaults of Chinese Sensible Code**

### Enable/Disable Chinese Sensible Code



@CSCENA1

**Enable Chinese Sensible Code**



@CSCENA0

**\*\* Disable Chinese Sensible Code**



If the scanner fails to identify Chinese Sensible Code barcodes, you may first try this solution by scanning the **Enter Setup** barcode and then **Enable Chinese Sensible Code** barcode.

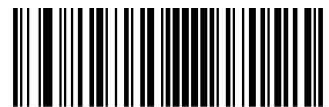

#SETUPE1  
**Enter Setup**



#SETUPE1  
Enter Setup

---

## Set Length Range for Chinese Sensible Code

The scanner can be configured to only decode Chinese Sensible Code barcodes with lengths that fall between (inclusive) the minimum and maximum lengths. To accomplish it, you need to set the minimum and maximum lengths.



@CSCMIN  
**Set the Minimum Length (Default: 1)**



@CSCMAX  
**Set the Maximum Length (Default: 7827)**



Minimum length is not allowed to be greater than maximum length. If you only want to read Chinese Sensible Code barcodes with a specific length, set both minimum and maximum lengths to be that desired length.

## **E** *sample*

**Set the scanner to decode Chinese Sensible Code barcodes containing between 8 and 12 characters:**

1. Scan the **Enter Setup** barcode.
2. Scan the **Set the Minimum Length** barcode.
3. Scan the numeric barcode “8” from the “Digit Barcodes” section in Appendix.
4. Scan the **Save** barcode from the “Save/Cancel Barcodes” section in Appendix.
5. Scan the **Set the Maximum Length** barcode.
6. Scan the numeric barcodes “1” and “2” from the “Digit Barcodes” section in Appendix.
7. Scan the **Save** barcode from the “Save/Cancel Barcodes” section in Appendix.
8. Scan the **Exit Setup** barcode.



#SETUPE1  
Enter Setup



#SETUPE1

Enter Setup

---

## Chinese Sensible Twin Code

Chinese Sensible twin code is 2 Chinese Sensible barcodes paralleled vertically or horizontally. They must both be either regular or inverse barcodes. They must have similar specifications and be placed closely together.

There are 3 options for reading Chinese Sensible twin codes:

- ◇ **Single Chinese Sensible Code Only:** Read either Chinese Sensible code.
- ◇ **Twin Chinese Sensible Code Only:** Read both Chinese Sensible codes. Transmission sequence: left (upper) Chinese Sensible code followed by right (lower) Chinese Sensible code.
- ◇ **Both Single & Twin:** Read both Chinese Sensible codes. If successful, transmit as twin Chinese Sensible Code only. Otherwise, try single Chinese Sensible Code only.



@CSCDOU0

\*\* Single Chinese Sensible Code Only



@CSCDOU1

Twin Chinese Sensible Code Only



@CSCDOU2

Both Single & Twin



#SETUPE1

Enter Setup



#SETUPE1  
Enter Setup

---

### Chinese Sensible Code Inverse

Regular barcode: Dark bars on a bright background.

Inverse barcode: Bright bars on a dark background.



@CSCINV0

**\*\* Decode Regular Chinese Sensible Barcodes Only**

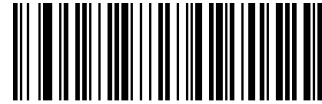

@CSCINV1

**Decode Inverse Chinese Sensible Barcodes Only**



@CSCINV2

**Decode Both**

### ECI Output

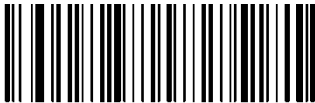

@CSCEC0

**Disable ECI Output**



@CSCEC1

**\*\* Enable ECI Output**



#SETUPE1  
Enter Setup



#SETUPE1  
**Enter Setup**

---

## GM Code Restore Factory Defaults



@GMCDEF  
**Restore the Factory Defaults of GM**

## Enable/Disable GM



@GMCENA1  
**Enable GM**



@GMCENA0  
**\*\* Disable GM**



If the scanner fails to identify GM barcodes, you may first try this solution by scanning the **Enter Setup** barcode and then **Enable GM** barcode.

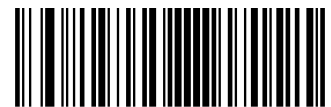

#SETUPE1  
**Enter Setup**



#SETUPE1  
**Enter Setup**

## Set Length Range for GM

The scanner can be configured to only decode GM barcodes with lengths that fall between (inclusive) the minimum and maximum lengths. To accomplish it, you need to set the minimum and maximum lengths.



**Set the Minimum Length (Default: 1)**



**Set the Maximum Length (Default: 2751)**



Minimum length is not allowed to be greater than maximum length. If you only want to read GM barcodes with a specific length, set both minimum and maximum lengths to be that desired length.



**Set the scanner to decode GM barcodes containing between 8 and 12 characters:**

1. Scan the **Enter Setup** barcode.
2. Scan the **Set the Minimum Length** barcode.
3. Scan the numeric barcode “8” from the “Digit Barcodes” section in Appendix.
4. Scan the **Save** barcode from the “Save/Cancel Barcodes” section in Appendix.
5. Scan the **Set the Maximum Length** barcode.
6. Scan the numeric barcodes “1” and “2” from the “Digit Barcodes” section in Appendix.
7. Scan the **Save** barcode from the “Save/Cancel Barcodes” section in Appendix.
8. Scan the **Exit Setup** barcode.



#SETUPE1  
**Enter Setup**



#SETUPE1  
**Enter Setup**

---

## Code One Restore Factory Defaults



@ONEDEF  
**Restore the Factory Defaults of Code One**

## Enable/Disable Code One



@ONEENA1  
**Enable Code One**

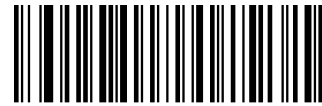

@ONEENA0  
**\*\* Disable Code One**



If the scanner fails to identify Code One barcodes, you may first try this solution by scanning the **Enter Setup** barcode and then **Enable Code One** barcode.

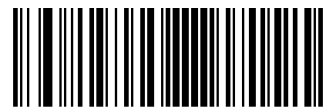

#SETUPE1  
**Enter Setup**



#SETUPE1  
Enter Setup

## Set Length Range for Code One

The scanner can be configured to only decode Code One barcodes with lengths that fall between (inclusive) the minimum and maximum lengths. To accomplish it, you need to set the minimum and maximum lengths.



Set the Minimum Length (Default: 1)



Set the Maximum Length (Default: 3550)



Minimum length is not allowed to be greater than maximum length. If you only want to read Code One barcodes with a specific length, set both minimum and maximum lengths to be that desired length.

## Example

Set the scanner to decode Code One barcodes containing between 8 and 12 characters:

1. Scan the **Enter Setup** barcode.
2. Scan the **Set the Minimum Length** barcode.
3. Scan the numeric barcode “8” from the “Digit Barcodes” section in Appendix.
4. Scan the **Save** barcode from the “Save/Cancel Barcodes” section in Appendix.
5. Scan the **Set the Maximum Length** barcode.
6. Scan the numeric barcodes “1” and “2” from the “Digit Barcodes” section in Appendix.
7. Scan the **Save** barcode from the “Save/Cancel Barcodes” section in Appendix.
8. Scan the **Exit Setup** barcode.



#SETUPE1  
Enter Setup





#SETUPE1  
Enter Setup

---

## DotCode Restore Factory Defaults



@DOTDEF  
Restore the Factory Defaults of DotCode

## Enable/Disable DotCode



@DOTENA1  
Enable DotCode



@DOTENA0  
\*\* Disable DotCode



If the scanner fails to identify DotCode barcodes, you may first try this solution by scanning the **Enter Setup** barcode and then **Enable DotCode** barcode.

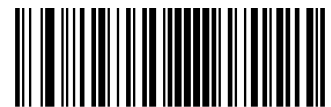

#SETUPE1  
Enter Setup



#SETUPE1  
Enter Setup

## USPS Postnet Restore Factory Defaults



@PNTDEF  
Restore the Factory Defaults of USPS Postnet

## Enable/Disable USPS Postnet



@PNTENA1  
Enable USPS Postnet



@PNTENA0  
**\*\* Disable USPS Postnet**



If the scanner fails to identify USPS Postnet barcodes, you may first try this solution by scanning the **Enter Setup** barcode and then **Enable USPS Postnet** barcode.

## Transmit Check Character



@PNTCHK1  
Do Not Transmit USPS Postnet Check Character



@PNTCHK2  
**\*\* Transmit USPS Postnet Check Character**



#SETUPE1  
Enter Setup



#SETUPE1  
Enter Setup

---

## USPS Intelligent Mail Restore Factory Defaults



@ILGDEF  
Restore the Factory Defaults of USPS Intelligent Mail

## Enable/Disable USPS Intelligent Mail



@ILGENA1  
Enable USPS Intelligent Mail



@ILGENA0  
**\*\* Disable USPS Intelligent Mail**



If the scanner fails to identify USPS Intelligent Mail barcodes, you may first try this solution by scanning the **Enter Setup** barcode and then **Enable USPS Intelligent Mail** barcode.

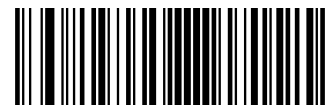

#SETUPE1  
Enter Setup



#SETUPE1  
**Enter Setup**

---

## Royal Mail Restore Factory Defaults



@ROYDEF  
**Restore the Factory Defaults of Royal Mail**

## Enable/Disable Royal Mail



@ROYENA1  
**Enable Royal Mail**

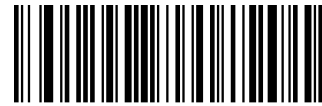

@ROYENA0  
**\*\* Disable Royal Mail**



If the scanner fails to identify Royal Mail barcodes, you may first try this solution by scanning the **Enter Setup** barcode and then **Enable Royal Mail** barcode.



#SETUPE1  
**Enter Setup**



#SETUPE1  
Enter Setup

## USPS Planet Restore Factory Defaults



@PLADEF  
Restore the Factory Defaults of USPS Planet

## Enable/Disable USPS Planet



@PLAENA1  
Enable USPS Planet



@PLAENA0  
\*\* Disable USPS Planet



If the scanner fails to identify USPS Planet barcodes, you may first try this solution by scanning the **Enter Setup** barcode and then **Enable USPS Planet** barcode.

## Transmit Check Character



@PLACHK1  
Do Not Transmit USPS Planet Check Character

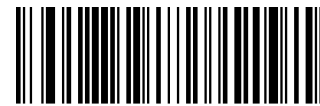

@PLACHK2  
\*\* Transmit USPS Planet Check Character

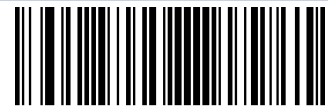

@SETUPE0  
\*\* Exit Setup



#SETUPE1  
**Enter Setup**

---

## KIX Post Restore Factory Defaults



@KIXDEF  
**Restore the Factory Defaults of KIX Post**

## Enable/Disable KIX Post



@KIXENA1  
**Enable KIX Post**

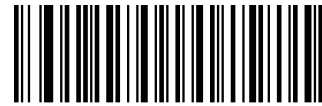

@KIXENA0  
**\*\* Disable KIX Post**



If the scanner fails to identify KIX Post barcodes, you may first try this solution by scanning the **Enter Setup** barcode and then **Enable KIX Post** barcode.



@SETUPE0  
**\*\* Exit Setup**



#SETUPE1  
**Enter Setup**

---

## Australian Postal Restore Factory Defaults



@APLDEF

**Restore the Factory Defaults of Australian Postal**

## Enable/Disable Australian Postal



@APLENA1

**Enable Australian Postal**

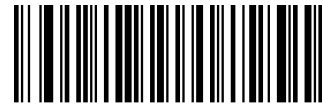

@APLENA0

**\*\* Disable Australian Postal**



If the scanner fails to identify Australian Postal barcodes, you may first try this solution by scanning the **Enter Setup** barcode and then **Enable Australian Postal** barcode.



@SETUPE0  
**\*\* Exit Setup**



#SETUPE1  
Enter Setup

---

## Japan Post Restore Factory Defaults



@JPPDEF  
Restore the Factory Defaults of Japan Post

## Enable/Disable Specific Japan Post



@JPPENA1  
Enable Japan Post



@JPPENA0  
**\*\* Disable Japan Post**



If the scanner fails to identify Specific Japan Post barcodes, you may first try this solution by scanning the **Enter Setup** barcode and then **Enable Japan Post** barcode.



@SETUPE0  
**\*\* Exit Setup**





#SETUPE1  
**Enter Setup**

---

## Passport OCR

### Restore Factory Defaults



@PASDEF  
**Restore the Factory Defaults of Passport OCR**

### Enable/Disable Passport OCR



@PASENA1  
**Enable Passport OCR**



@PASENA0  
**\*\* Disable Passport OCR**



If the scanner fails to identify Passport OCR barcodes, you may first try this solution by scanning the **Enter Setup** barcode and then **Enable Passport OCR** barcode.



@SETUPE0  
**\*\* Exit Setup**



#SETUPE1  
Enter Setup

---

## Chinese ID Card OCR Restore Factory Defaults



@IDCDEF  
\*\* Restore the Factory Defaults of Chinese ID Card OCR

## Enable/Disable Chinese ID Card OCR



@IDCENA1  
Enable Chinese ID Card OCR



@IDCENA0  
\*\* Disable Chinese ID Card OCR

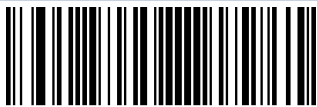

@SETUPE0  
\*\* Exit Setup



#SETUPE1  
Enter Setup

---

## China Travel Permit OCR Restore Factory Defaults



@CTPDEF  
\*\* Restore the Factory Defaults of China Travel  
Permit OCR

## Enable/Disable Chinese Travel Permit OCR



@CTPENA1  
Enable Chinese Travel Permit OCR



@CTPENA0  
\*\* Disable Chinese Travel Permit OCR



@SETUPE0  
\*\* Exit Setup



#SETUPE1

Enter Setup

## Chapter 6 Prefix&Suffix

### Introduction

A 1D barcode could contain digits, letters, symbols, etc. A 2D barcode could contain more data, such as Chinese characters and other multi-byte characters. However, in real applications, they do not and should not have all information we need, such as barcode type, data acquisition time and delimiter, in order to keep the barcodes short and flexible.

Prefix and suffix are how to fulfill the needs mentioned above. They can be added, removed and modified while the original barcode data remains intact.



Barcode processing procedure:

1. Edit data with Data Formatter
2. Append prefix/suffix
3. Pack data
4. Append terminating character



#SETUPE1

Enter Setup



#SETUPE1  
Enter Setup

## Global Settings

### Enable/Disable All Prefixes/Suffixes

**Disable All Prefixes/Suffixes:** Transmit barcode data with no prefix/suffix.

**Enable All Prefixes/Suffixes:** Allow to append Code ID prefix, AIM ID prefix, custom prefix/suffix and terminating character to the barcode data before the transmission.



@APSENA0  
**Disable All Prefixes/Suffixes**



@APSENA1  
**Enable All Prefixes/Suffixes**

## Prefix Sequence



@PRESEQ0  
**\*\* Code ID+ Custom +AIM ID**



@PRESEQ1  
**Custom + Code ID + AIM ID**



@SETUPE0  
**\*\* Exit Setup**



#SETUPE1  
Enter Setup

---

## Custom Prefix

### Enable/Disable Custom Prefix

If custom prefix is enabled, you are allowed to append to the data a user-defined prefix that cannot exceed 10 characters. For example, if the custom prefix is “AB” and the barcode data is “123”, the Host will receive “AB123”.



@CPRENA0  
\*\* Disable Custom Prefix



@CPRENA1  
Enable Custom Prefix

### Set Custom Prefix

To set a custom prefix, scan the **Set Custom Prefix** barcode then the numeric barcodes corresponding to the hexadecimal value of a desired prefix then the **Save** barcode.

**Note:** A custom prefix cannot exceed 10 characters.



@CPRSET  
Set Custom Prefix

Set the custom prefix to “CODE” (HEX: 0x43/0x4F/0x44/0x45):

**E**  
*xample*

1. Scan the **Enter Setup** barcode.
2. Scan the **Set Custom Prefix** barcode.
3. Scan the numeric barcodes “4”, “3”, “4”, “F”, “4”, “4”, “4” and “5” from the “Digit Barcodes” section in Appendix.
4. Scan the **Save** barcode from the “Save/Cancel Barcodes” section in Appendix.
5. Scan the **Enable Custom Prefix** barcode.
6. Scan the **Exit Setup** barcode.



#SETUPE1  
Enter Setup



#SETUPE1  
Enter Setup

---

## AIM ID Prefix

AIM (Automatic Identification Manufacturers) ID defines symbology identifier (For the details, see the “AIM ID Table” section in Appendix). If AIM ID prefix is enabled, the scanner will add the symbology identifier before the scanned data after decoding.



**\*\* Disable AIM ID Prefix**



**Enable AIM ID Prefix**



AIM ID is not user programmable.



#SETUPE1  
Enter Setup



#SETUPE1  
**Enter Setup**

---

## Code ID Prefix

Code ID can also be used to identify barcode type. Unlike AIM ID, Code ID is user programmable. Code ID can only consist of one or two English letters.



@CIDENA0  
**\*\* Disable Code ID Prefix**



@CIDENA1  
**Enable Code ID Prefix**

## Restore All Default Code IDs

For the information of default Code IDs, see the “Code ID Table” section in Appendix.



@CIDDEF  
**Restore All Default Code IDs**

## Modify Code ID

See the examples below to learn how to modify a Code ID and restore the default Code IDs of all symbologies.



#SETUPE1  
**Enter Setup**





#SETUPE1  
**Enter Setup**

---

## **E** *sample*

### **Modify PDF417 Code ID to be “p” (HEX: 0x70):**

1. Scan the **Enter Setup** barcode.
2. Scan the **Modify PDF417 Code ID** barcode.
3. Scan the numeric barcodes “7” and “0” from the “Digit Barcodes” section in Appendix.
4. Scan the **Save** barcode from the “Save/Cancel Barcodes” section in Appendix.
5. Scan the **Exit Setup** barcode.

### **Restore the default Code IDs of all symbologies:**

1. Scan the **Enter Setup** barcode.
2. Scan the **Restore All Default Code IDs** barcode.
3. Scan the **Exit Setup** barcode.



#SETUPE1  
**Enter Setup**



#SETUPE1  
Enter Setup

---

**1D symbologies:**



@CID002  
**Modify Code 128 Code ID**



@CID004  
**Modify EAN-8 Code ID**



@CID006  
**Modify UPC-E Code ID**



@CID008  
**Modify Interleaved 2 of 5 Code ID**



@CID003  
**Modify GS1-128 Code ID**



@CID005  
**Modify EAN-13 Code ID**



@CID007  
**Modify UPC-A Code ID**



#SETUPE1  
Enter Setup



#SETUPE1  
Enter Setup

---



@CID009  
Modify ITF-14 Code ID



@CID010  
Modify ITF-6 Code ID



@CID011  
Modify Matrix 2 of 5 Code ID



@CID013  
Modify Code 39 Code ID



@CID015  
Modify Codabar Code ID



@CID017  
Modify Code 93 Code ID



@CID019  
Modify China Post 25 Code ID



@CID020  
Modify AIM 128 Code ID



#SETUPE1  
Enter Setup



#SETUPE1  
**Enter Setup**

---



@CID023  
**Modify ISSN Code ID**



@CID025  
**Modify Industrial 25 Code ID**



@CID027  
**Modify Plessey Code ID**



@CID029  
**Modify MSI-Plessey Code ID**



@CID021  
**Modify ISBT 128 Code ID**



@CID024  
**Modify ISBN Code ID**



@CID026  
**Modify Standard 25 Code ID**



@CID028  
**Modify Code 11 Code ID**



#SETUPE1  
**Enter Setup**



#SETUPE1  
**Enter Setup**

---



@CID030  
**Modify GS1 Composite Code ID**



@CID031  
**Modify GS1 Databar Code ID**



@CID132  
**Modify Code 49 Code ID**



@CID133  
**Modify Code 16K Code ID**



#SETUPE1  
**Enter Setup**



#SETUPE1  
**Enter Setup**

---

**2D symbologies:**



@CID032  
**Modify PDF417 Code ID**



@CID034  
**Modify Aztec Code ID**



@CID036  
**Modify Maxicode Code ID**



@CID041  
**Modify GM Code ID**



@CID033  
**Modify QR Code ID**



@CID035  
**Modify Data Matrix Code ID**



@CID039  
**Modify Chinese Sensible Code ID**



#SETUPE1  
**Enter Setup**





#SETUPE1  
**Enter Setup**

---



@CID042  
**Modify Micro PDF417 Code ID**



@CID043  
**Modify Micro QR Code ID**

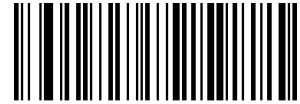

@CID048  
**Modify Code One Code ID**



#SETUPE1  
**Enter Setup**





#SETUPE1  
Enter Setup

---

**Postal symbologies:**



@CID096

**Modify USPS Postnet Code ID**



@CID097

**Modify USPS Intelligent Mail Code ID**



@CID098

**Modify Royal Mail Code ID**



@CID099

**Modify USPS Planet Code ID**



@CID100

**Modify KIX Post Code ID**



@CID101

**Modify Australian Postal Code ID**



#SETUPE1  
Enter Setup



#SETUPE1  
Enter Setup

---

## Custom Suffix

### Enable/Disable Custom Suffix

If custom suffix is enabled, you are allowed to append to the data a user-defined suffix that cannot exceed 10 characters. For example, if the custom suffix is “AB” and the barcode data is “123”, the Host will receive “123AB”.



@CSUENA0  
\*\* Disable Custom Suffix

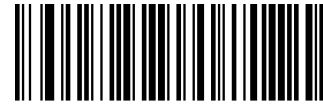

@CSUENA1  
Enable Custom Suffix

### Set Custom Suffix

To set a custom suffix, scan the **Set Custom Suffix** barcode then the numeric barcodes corresponding to the hexadecimal value of a desired suffix then the **Save** barcode.

**Note:** A custom suffix cannot exceed 10 characters.



@CSUSET  
Set Custom Suffix

**E**  
*sample*

**Set the custom suffix to “CODE” (HEX: 0x43/0x4F/0x44/0x45):**

1. Scan the **Enter Setup** barcode.
2. Scan the **Set Custom Suffix** barcode.
3. Scan the numeric barcodes “4”, “3”, “4”, “F”, “4”, “4”, “4” and “5” from the “Digit Barcodes” section in Appendix.
4. Scan the **Save** barcode from the “Save/Cancel Barcodes” section in Appendix.
5. Scan the **Enable Custom Suffix** barcode.
6. Scan the **Exit Setup** barcode.



#SETUPE1  
Enter Setup



#SETUPE1

Enter Setup

---

## Data Packing

### Introduction

Data packing is designed for a specific group of users who want to have the data packed before transmission. Data packing influences data format, so it is advised to disable this feature when it is not required.

### Data Packing Options

**Disable Data Packing:** Transmit decoded data in raw format (unpacked).

**Enable Data Packing, Format 1:** Transmit decoded data with the packet format 1 defined below.

Packet format 1: [STX + ATTR + LEN] + [AL\_TYPE + DATA] + [LRC]

STX: 0x02

ATTR: 0x00

LEN: Barcode data length is expressed in 2 bytes ranging from 0x0000 (0) to 0xFFFF (65535).

AL\_TYPE: 0x36

DATA: Raw barcode data.

LRC: Check digit.

LRC calculation algorithm: computation sequence: 0xFF+LEN+AL\_TYPE+DATA; computation method is XOR, byte by byte.

**Enable Data Packing, Format 2:** Transmit decoded data with the packet format 2 defined below.

Packet format 2: [STX + ATTR + LEN] + [AL\_TYPE] + [Symbology\_ID + DATA] + [LRC]

STX: 0x02

ATTR: 0x00

LEN: Barcode data length is expressed in 2 bytes ranging from 0x0000 (0) to 0xFFFF (65535).

AL\_TYPE: 0x3B

Symbology\_ID: The ID number of symbology, 1 byte.

DATA: Raw barcode data.

LRC: Check digit.

LRC calculation algorithm: computation sequence: 0xFF+LEN+AL\_TYPE+Symbology\_ID+DATA; computation method is XOR, byte by byte.



#SETUPE1

Enter Setup



#SETUPE1  
**Enter Setup**

---



@PACKAG0  
**\*\* Disable Data Packing**



@PACKAG1  
**Enable Data Packing, Format 1**



@PACKAG2  
**Enable Data Packing, Format 2**



#SETUPE1  
**Enter Setup**



#SETUPE1  
Enter Setup

## Terminating Character Suffix

### Enable/Disable Terminating Character Suffix

A terminating character such as carriage return (CR) or carriage return/line feed pair (CRLF) can only be used to mark the end of data, which means nothing can be added after it.

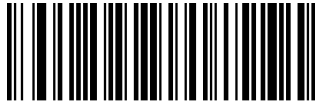

@TSUENA0

**Disable Terminating Character Suffix**



@TSUENA1

**\*\* Enable Terminating Character Suffix**

### Set Terminating Character Suffix

To set a terminating character suffix, scan the **Set Terminating Character Suffix** barcode then the numeric barcodes corresponding to the hexadecimal value of a desired terminating character then the **Save** barcode.

**Note:** A terminating character suffix cannot exceed 2 characters.



@TSUSET

**Set Terminating Character Suffix**



@TSUSET0D

**\*\* Set Terminating Character to CR (0x0D)**



@TSUSET0D0A

**Set Terminating Character to CRLF (0x0D,0x0A)**



#SETUPE1  
Enter Setup



#SETUPE1  
**Enter Setup**

---

## **E** *sample*

### **Set the terminating character suffix to 0x0A:**

1. Scan the **Enter Setup** barcode.
2. Scan the **Set Terminating Character Suffix** barcode.
3. Scan the numeric barcodes "0" and "A" from the "Digit Barcodes" section in Appendix.
4. Scan the **Save** barcode from the "Save/Cancel Barcodes" section in Appendix.
5. Scan the **Enable Terminating Character Suffix** barcode.
6. Scan the **Exit Setup** barcode.



#SETUPE1  
**Enter Setup**

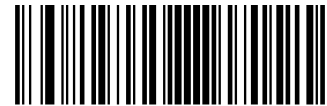

#SETUPE1  
Enter Setup

## Chapter 7 Batch Programming

### Introduction

Batch programming enables users to integrate a batch of commands into a single batch barcode.

Listed below are batch programming rules:

1. Command format: Command + Parameter Value.
2. Each command is terminated by a semicolon (;). Note that there is no space between a command and its terminator semicolon.
3. Use the barcode generator software to generate a 2D batch barcode.

Example: Create a batch barcode for **Normal Illumination, Sense Mode, Decode Session Timeout = 2s, Disable Interleaved 2 of 5:**

1. Input the commands:

@ILLSCN1;SCNMOD2;ORTSET2000;I25ENA0;

2. Generate a batch barcode.

When setting up a scanner with the above configuration, scan the **Enable Batch Barcode** barcode and then the batch barcode generated.



@BATCHS  
**Enable Batch Barcode**



#SETUPE1  
Enter Setup



#SETUPE1

**Enter Setup**

---

## Create a Batch Command

A batch command may contain a number of individual commands each of which is terminated by a semicolon (;). For more information, refer to the “Use of Programming Command” section in Chapter 3.

## Create a Batch Barcode

Batch barcodes can be produced in the format of PDF417, QR Code or Data Matrix.

Example: Create a batch barcode for **Normal Illumination, Sense Mode, Decode Session Timeout = 2s, Disable Interleaved 2 of 5:**

1. Input the following commands:

```
@ILLSCN1;SCNMOD2;ORTSET2000;I25E
```

```
NA0;
```

2. Generate a PDF417 batch barcode.



@SETUPE0

**\*\* Exit Setup**



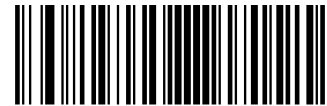

#SETUPE1  
Enter Setup

---

## Use Batch Barcode

To put a batch barcode into use, scan the following barcodes. (Use the example above.)



@SETUPE1  
Enter Setup



@BATCHS  
Enable Batch Barcode



Batch Barcode

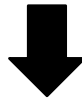

@SETUPE0  
Exit Setup



#SETUPE1  
Enter Setup

# Appendix

## Digit Barcodes

0~9





@DIGIT6

6



@DIGIT7

7



@DIGIT8

8

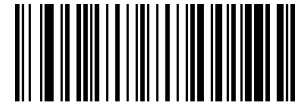

@DIGIT9

9

A~F



@DIGITA

A



@DIGITB

B



@DIGITC

C



@DIGITD

D



@DIGITE

E



@DIGITF

F

---

## Save/Cancel Barcodes

After reading numeric barcode(s), you need to scan the **Save** barcode to save the data. If you scan the wrong digit(s), you can either scan the **Cancel** barcode and then start the configuration all over again, or scan the **Delete the Last Digit** barcode and then the correct digit, or scan the **Delete All Digits** barcode and then the digits you want.

For instance, after reading the **Maximum Length** barcode and numeric barcodes “1”, “2” and “3”, you scan:

- ❖ **Delete the Last Digit:** The last digit “3” will be removed.
- ❖ **Delete All Digits:** All digits “123” will be removed.
- ❖ **Cancel:** The maximum length configuration will be cancelled. And the scanner is still in the setup mode.



## Factory Defaults Table

Parameters	Factory Default	Remark
<b>System Settings</b>		
<b>Hardware Settings</b>		
Good Read LED	On	
Good Read LED Duration	Medium (120ms)	1-2,000ms
Illumination	On	
Aiming	On	
Good Read Vibration	On	
Good Read Vibration Duration	100	1-2,000ms
Image Flipping	Do Not Flip	
<b>Beep</b>		
Power On Beep	On	
Good Read Beep	On	
Good Read Beep Volume	High(20)	1-20
Good Read Beep Duration	Medium (80ms)	20-300ms
Good Read Beep Frequency	Medium (2730Hz)	
<b>Scan Settings</b>		
Barcode Programming	Disabled (Exit Setup)	
Programming Barcode Data	Do not transmit	
Scan Mode	Level Mode	
Smart Stand Mode	Enabled	
Trigger Commands	Disabled	
Image Stabilization Timeout (Sense Mode)	200ms	0-3,000ms
Decode Session Timeout	3,000ms.	0-3,600,000ms
Reread Timeout	Disabled	
	1500ms	1-3600000ms
Reset Reread Timeout	Off	
Image Decoding Timeout	500ms	1-3,000ms
Sensitivity	Enhanced Sensitivity (5)	1-20
Scanning Preference	Normal	
Read Barcode	On	
Image Luminance Limit	Disabled	
Custom Image Luminance	80	1-255
Exposure parameter Limit	Enabled	
Minimum Exposure Time	50 $\mu$ s	50-14,000 $\mu$ s
Maximum Exposure Time	2000 $\mu$ s	50-14,000 $\mu$ s
Gain Parameter Limit	Disabled	
Maximum Gain	49	1-64
Minimum Gain	1	1-64
Decode Area	Whole Area Decoding	

Transmit Bad Read Message	Disabled	
Modified Bad Read Message	NG	
Transmit Delay per Character for Febraban	Disabled	
Custom Transmit Delay per Character for Febraban	70ms	
Transmit Delay per 12 Characters for Febraban	Disabled	
Custom Transmit Delay per 12 Characters for Febraban	500ms	
USB Data Transmission Failure Notification	Disabled	
Transmit GS1 Check Character	Enabled	
GS1-128(UCC/EAN-13)	Transmit GS1 Check Character	
GS1 Databar(RSS)	Transmit GS1 Check Character	
GS1 QR	Transmit GS1 Check Character	
GS1 Data Matrix	Transmit GS1 Check Character	
<b>Interface</b>		
Interface	Bluetooth Dongle KBW	
<b>Keyboard</b>		
USB Country Keyboard	US keyboard	USB HID Keyboard
Emulate ALT+Keypad	Off	USB HID Keyboard
Control Characters Output	Disabled	USB HID Keyboard
Inter-Keystroke Delay	No Delay	USB HID Keyboard
Caps Lock	Off(Non Japanese Keypad)	USB HID Keyboard
Convert Case	No Case Conversion	USB HID Keyboard
Emulate Numeric Keypad 1	Off	USB HID Keyboard
Emulate Numeric Keypad 2	Off	USB HID Keyboard
Fast Mode	Off	USB HID Keyboard
Polling Rate	4ms	USB HID Keyboard
Unicode Encoding	Off	USB HID Keyboard
Beep on Unknown Character	Off	USB HID Keyboard
Emulate Keypad with Leading Zero	On	USB HID Keyboard
Code Page	Code Page 1252 (Latin, Western European)	USB HID Keyboard
<b>Symbologies</b>		
<b>1D Barcode</b>		
1D Twin Code	Single 1D Code Only	

Parentheses Surround GS1 Application Identifiers	Disabled	
Output GS1 Application Identifiers	Disabled	
<b>Code 11</b>		
Code 11	Enabled	
Maximum Length	127	
Minimum Length	1	
Check Character Verification	One Check Character, MOD11	
Check Character	Transmit	
<b>Code 128</b>		
Code 128	Enabled	
Maximum Length	127	
Minimum Length	1	
<b>Code 39</b>		
Code 39	Enabled	
Maximum Length	127	
Minimum Length	1	
Check Character Verification	Disabled	
Start/Stop Character	Do not transmit	
Code 39 Full ASCII	Disabled	
Code 32 Pharmaceutical (PARAF)	Disabled	
Code 32 Prefix	Disabled	
Code 32 Start/Stop Character	Do not transmit	
Code 32 Check Character	Do not transmit	
<b>GS1-128(UCC/EAN-128)</b>		
UCC/EAN-128	Enabled	
Maximum Length	127	
Minimum Length	1	
<b>AIM 128</b>		
AIM 128	Enabled	
Maximum Length	127	
Minimum Length	1	
<b>ISBT 128</b>		
ISBT 128	Disabled	
<b>Codabar</b>		
Codabar	Enabled	
Maximum Length	127	
Minimum Length	1	
Check Character Verification	Disabled	
Start/Stop Character	Do not transmit	
	ABCD/ABCD	All capital



<b>Code 93</b>		
Code 93	Enabled	
Maximum Length	127	
Minimum Length	1	
<b>UPC-A</b>		
UPC-A	Enabled	
Check Character	Transmit	
2-Digit Add-On Code	Disabled	
5-Digit Add-On Code	Disabled	
Add-On Code Required	Not Required	
Transmit Preamble Character	System Character	
<b>UPC-E</b>		
UPC-E	Enabled	
UPC-E0	Enabled	
UPC-E1	Disabled	
Check Character	Transmit	
2-Digit Add-On Code	Disabled	
5-Digit Add-On Code	Disabled	
Add-On Code Required	Not Required	
Transmit Preamble Character	System Character	
Convert UPC-E to UPC-A	Disable UPC-E Extend	
<b>Coupon</b>		
UPC-A/EAN-13 with Extended Coupon Code	Off	
Coupon GS1 DataBar Output	Off	
<b>GS1 Composite</b>		
GS1 Composite	Disabled	
UPC/EAN Composite	Disabled	
<b>EAN-13</b>		
EAN-13	Enabled	
Check Character	Transmit	
2-Digit Add-On Code	Disabled	
5-Digit Add-On Code	Disabled	
Add-On Code Required	Disabled	
EAN-13 Beginning with 290 Add-On Code Required	Do Not Require Add-On Code	
EAN-13 Beginning with 378/379 Add-On Code Required	Do Not Require Add-On Code	
EAN-13 Beginning with 414/419 Add-On Code Required	Do Not Require Add-On Code	
EAN-13 Beginning with 434/439 Add-On Code Required	Do Not Require Add-On Code	
EAN-13 Beginning with 977 Add-On Code		

Required	Do Not Require Add-On Code	
EAN-13 Beginning with 978 Add-On Code Required	Do Not Require Add-On Code	
EAN-13 Beginning with 979 Add-On Code Required	Do Not Require Add-On Code	
Japanese Magazine Code	Disabled	
<b>EAN-8</b>		
EAN-8	Enabled	
Check Character	Transmit	
2-Digit Add-On Code	Disabled	
5-Digit Add-On Code	Disabled	
Add-On Code Required	Not Required	
<b>ISBN</b>		
ISBN	Disabled	
Set ISBN Format	ISBN-10	
2-Digit Add-On Code	Disabled	
5-Digit Add-On Code	Disabled	
Add-On Code Required	Not Required	
Japanese Book Code	Disabled	
Japanese Book Code Separator	Disable Japanese Book Code Separator	
<b>ISSN</b>		
ISSN	Disabled	
2-Digit Add-On Code	Disabled	
5-Digit Add-On Code	Disabled	
Add-On Code Required	Not Required	
<b>Interleaved 2 of 5</b>		
Interleaved 2 of 5	Enabled	
Maximum Length	127	
Minimum Length	1	
Check Character Verification	Enable, But Do Not Transmit Check Character	
Febraban	Febraban Disabled	
Safety Level	Safety Level of Interleaved 2 of 5 is one.	
<b>Matrix 2 of 5</b>		
Matrix 2 of 5	Disabled	
Maximum Length	127	
Minimum Length	1	
Check Character Verification	Enable, But Do Not Transmit Check Character	
<b>Industrial 25</b>		
Industrial 25	Disabled	

Maximum Length	127	
Minimum Length	1	
Check Character Verification	Disabled	
<b>ITF-14</b>		
ITF-14	Disabled	
<b>ITF-6</b>		
ITF-6	Disabled	
<b>Standard 25</b>		
Standard 25	Disabled	
Maximum Length	127	
Minimum Length	1	
Check Character Verification	Do Not Transmit Check Character After Verification	
<b>China Post 25</b>		
China Post 25	Disabled	
Maximum Length	127	
Minimum Length	1	
Check Character Verification	Disabled	
<b>Deutsche 14</b>		
Deutsche 14	Disabled	
<b>Deutsche 12</b>		
Deutsche 12	Disabled	
<b>MSI-Plessey</b>		
MSI-Plessey	Disabled	
Maximum Length	127	
Minimum Length	1	
Check Character Verification	One Check Character, MOD10	
Check Character	Enabled	
<b>Plessey</b>		
Plessey	Disabled	
Maximum Length	127	
Minimum Length	1	
Check Character Verification	Disabled	
<b>GS1 Databar</b>		
GS1 Databar	Enabled	
Application Identifier "01"	Transmit	
<b>Code 49</b>		
Code 49	Disabled	
Maximum Length	127	
Minimum Length	1	
<b>Code 16K</b>		
Code 16K	Disabled	
Maximum Length	127	
Minimum Length	1	

<b>2D Barcode</b>		
<b>PDF417</b>		
PDF417	Enabled	
Maximum Length	2710	
Minimum Length	1	
PDF417 Twin Code	Single PDF417 Only	
PDF417 Inverse	Decode Regular PDF417 Barcodes Only	
Character Encoding	Default Character Encoding	
PDF417 ECI Output	Enabled	
<b>QR Code</b>		
QR Code	Enabled	
Maximum Length	7089	
Minimum Length	1	
QR Twin Code	Single QR Only	
QR Inverse	Decode Regular QR Barcodes Only	
Character Encoding	Default Character Encoding	
QR ECI Output	Enabled	
URL QR Code	Enabled	
<b>Aztec Code</b>		
Aztec Code	Disabled	
Maximum Length	3832	
Minimum Length	1	
Set the Number of Barcodes	1	
Read Multi-barcodes on an Image	Mode 1	
Character Encoding	Default Character Encoding	
Aztec ECI Output	Disabled	
<b>Data Matrix</b>		
Data Matrix	Enabled	
Maximum Length	3116	
Minimum Length	1	
Data Matrix Twin Code	Single Data Matrix Only	
Rectangular Barcode	Enabled	
Data Matrix Inverse	Decode Regular Data Matrix Barcodes Only	
Character Encoding	Default Character Encoding	
Data Matrix ECI Output	Enabled	
<b>Maxi Code</b>		
Maxi Code	Disabled	
Maximum Length	150	
Minimum Length	1	
<b>Chinese Sensible Code</b>		
Chinese Sensible Code	Disabled	

Maximum Length	7827	
Minimum Length	1	
Chinese Sensible Code Twin Code	Single Chinese Sensible Code Only	
Chinese Sensible Code Inverse	Decode Regular Chinese Sensible Bar Codes Only	
<b>GM Code</b>		
GM Code	Disabled	
Maximum Length	2751	
Minimum Length	1	
<b>Micro PDF417</b>		
Micro PDF417	Disabled	
Maximum Length	366	
Minimum Length	1	
<b>Micro QR Code</b>		
Micro QR Code	Enabled	
Maximum Length	35	
Minimum Length	1	
<b>Code One</b>		
Code One	Disabled	
Maximum Length	3550	
Minimum Length	1	
<b>Dot Code</b>		
Dot Code	Disabled	
Maximum Length	7089	
Minimum Length	1	
Dot Code Inverse	Dot Code Both	
<b>OCR</b>		
<b>Passport OCR</b>		
Passport OCR	Disabled	
<b>Chinese ID Card</b>		
Chinese ID Card	Disabled	
<b>China Travel Permit OCR</b>		
China Travel Permit OCR	Disabled	
<b>Postal</b>		
<b>USPS Postnet</b>		
USPS Postnet	Disabled	
Transmit Check Character	Transmit	
<b>USPS Intelligent Mail</b>		
USPS Intelligent Mail	Disabled	
<b>Royal Mail</b>		
Royal Mail	Disabled	
<b>USPS Planet</b>		
USPS Planet	Disabled	

Transmit Check Character	Transmit	
<b>KIX Post</b>		
KIX Post	Disabled	
<b>Australian Postal</b>		
Australian Postal	Disabled	
<b>Japan Post</b>		
Japan Post	Disabled	
<b>Code ID Prefix</b>	Disabled	
<b>Prefix &amp; Suffix</b>		
Prefix Sequence	Code ID+ Custom +AIM ID	
Custom Prefix	Disabled	
AIM ID Prefix	Disabled	
Custom Suffix	Disabled	
Terminating Character Suffix	Enabled	
Modify Terminating Character Suffix	0D	
<b>Data Formatter</b>		
Data Format	Disabled Data Format	
Change Data Format	Data Format 0	
Non-Match Error Beep	Enabled	
Data Packing	Disabled	
<b>Driver License Decoding</b>		
Advanced Formatting/Label Editing Scripts	Disabled	
Extract Elements	Disabled	
<b>Wireless Communications</b>		
Operating Mode	Bluetooth Dongle KBW	
Batch Mode Option	Off	
Prevent Same Barcode Storage	Off	
Batch Mode Transmit Delay	No Transmit Delay (0ms)	
End of Transmission Message	Off, EOT	
Auto Clear Stored Data after Transmission	Off	
Scanner Time	Set Date and Time	
Time Stamp	Do Not Send	
Time Stamp Format	Format 1: (YYYY/MM/DD,HH:MM:SS)	
Wireless Transmission Failure Beep	Enabled	
Bluetooth Connection Status	LED is on after Bluetooth connected	
Power-Off Timeout	5 minutes after inactivity	

## AIM ID Table

Symbology	AIM ID	Possible AIM ID Modifiers (m)
Code 128	]C0	
GS1-128 (UCC/EAN-128)	]C1	
EAN-8	]E4	
EAN-8 with Addon	]E3	
EAN-13	]E0	
EAN-13 with Addon	]E3	
UPC-E	]E0	
UPC-E with Addon	]E3	
UPC-A	]E0	
UPC-A with Addon	]E3	
Interleaved 2 of 5	]Im	0, 1, 3
ITF-14	]Im	1, 3
ITF-6	]Im	1, 3
Matrix 2 of 5	]X0	
Code 39	]Am	0, 1, 3, 4, 5, 7
Codabar	]Fm	0, 2, 4
Code 93	]G0	
China Post 25	]X0	
AIM 128	]C2	
ISBT 128	]C4	
ISSN	]X0	
ISBN	]X0	
Industrial 25	]S0	
Standard 25	]R0	
Plessey	]P0	
Code 11	]Hm	0, 1, 3
MSI Plessey	]Mm	0, 1
GS1 Composite	]em	0-3
GS1 Databar (RSS)	]e0	

Symbology	AIM ID	Possible AIM ID Modifiers (m)
PDF417	]Lm	0-2
QR Code	]Qm	0-6
Aztec	]zm	0-9, A-C
Data Matrix	]dm	0-6
Passport OCR	]o2	

**Note:** “m” represents the AIM modifier character. Refer to ISO/IEC 15424:2008 Information technology – Automatic identification and data capture techniques – Data Carrier Identifiers (including Symbology Identifiers) for AIM modifier character details.



## Code ID Table

Symbology	Code ID
Code128	j
GS1-128 (UCC/EAN-128)	j
EAN-8	d
EAN-13	d
UPC-E	c
UPC-A	c
Interleaved 2 of 5	e
ITF-14	e
ITF-6	e
Matrix 2 of 5	v
Code 39	b
Codabar	a
Code 93	i
China Post 25	X
AIM 128	X
ISBT 128	X
ISSN	g
ISBN	B
Industrial 25	l
Standard 25	f
Plessey	n
Code 11	H
MSI Plessey	m
GS1 Composite	y
GS1 Databar (RSS)	R
PDF417	r
QR Code	s
Aztec	z
Data Matrix	u
Passport OCR	O

## Symbology ID Number

Symbology	ID Number
Code 128	002
GS1-128 (UCC/EAN-128)	003
EAN-8	004
EAN-13	005
UPC-E	006
UPC-A	007
Interleaved 2 of 5, Febraban	008
ITF-14	009
ITF-6	010
Matrix 2 of 5	011
Code 39, Code 32	013
Codabar	015
Code 93	017
China Post 25	019
AIM 128	020
ISBT 128	021
ISSN	023
ISBN	024
Industrial 25	025
Standard 25	026
Plessey	027
Code11	028
MSI-Plessey	029
GS1 Composite	030
GS1 Databar (RSS)	031
PDF417	032
QR Code	033
Aztec	034
Data Matrix	035
Maxicode	036
Chinese Sensible Code	039
GM Code	040

---

Symbology	ID Number
Micro PDF417	042
Micro QR	043
Code One	048
Passport OCR	066

## ASCII Table

HEX	Dec	Char
00	0	NUL (Null char.)
01	1	SOH (Start of Header)
02	2	STX (Start of Text)
03	3	ETX (End of Text)
04	4	EOT (End of Transmission)
05	5	ENQ (Enquiry)
06	6	ACK (Acknowledgment)
07	7	BEL (Bell)
08	8	BS (Backspace)
09	9	HT (Horizontal Tab)
0a	10	LF (Line Feed)
0b	11	VT (Vertical Tab)
0c	12	FF (Form Feed)
0d	13	CR (Carriage Return)
0e	14	SO (Shift Out)
0f	15	SI (Shift In)
10	16	DLE (Data Link Escape)
11	17	DC1 (XON) (Device Control 1)
12	18	DC2 (Device Control 2)
13	19	DC3 (XOFF) (Device Control 3)
14	20	DC4 (Device Control 4)
15	21	NAK (Negative Acknowledgment)
16	22	SYN (Synchronous Idle)
17	23	ETB (End of Trans. Block)
18	24	CAN (Cancel)
19	25	EM (End of Medium)
1a	26	SUB (Substitute)
1b	27	ESC (Escape)

1c	28	FS (File Separator)
1d	29	GS (Group Separator)
1e	30	RS (Request to Send)
1f	31	US (Unit Separator)
20	32	SP (Space)
21	33	! (Exclamation Mark)
22	34	" (Double Quote)
23	35	# (Number Sign)
24	36	\$ (Dollar Sign)
25	37	% (Percent)
26	38	& (Ampersand)
27	39	` (Single Quote)
28	40	( (Right / Closing Parenthesis)
29	41	) (Right / Closing Parenthesis)
2a	42	* (Asterisk)
2b	43	+ (Plus)
2c	44	, (Comma)
2d	45	- (Minus / Dash)
2e	46	. (Dot)
2f	47	/ (Forward Slash)
30	48	0
31	49	1
32	50	2
33	51	3
34	52	4
35	53	5
36	54	6
37	55	7
38	56	8
39	57	9
3a	58	: (Colon)
3b	59	; (Semi-colon)
3c	60	< (Less Than)
3d	61	= (Equal Sign)

3e	62	> (Greater Than)
3f	63	? (Question Mark)
40	64	@ (AT Symbol)
41	65	A
42	66	B
43	67	C
44	68	D
45	69	E
46	70	F
47	71	G
48	72	H
49	73	I
4a	74	J
4b	75	K
4c	76	L
4d	77	M
4e	78	N
4f	79	O
50	80	P
51	81	Q
52	82	R
53	83	S
54	84	T
55	85	U
56	86	V
57	87	W
58	88	X
59	89	Y
5a	90	Z
5b	91	[ (Left / Opening Bracket)
5c	92	\ (Back Slash)
5d	93	] (Right / Closing Bracket)
5e	94	^ (Caret / Circumflex)
5f	95	_ (Underscore)
60	96	' (Grave Accent)
61	97	a
62	98	b
63	99	c
64	100	d
65	101	e

---

66	102	f
67	103	g
68	104	h
69	105	i
6a	106	j
6b	107	k
6c	108	l
6d	109	m
6e	110	n
6f	111	o
70	112	p
71	113	q
72	114	r
73	115	s
74	116	t
75	117	u
76	118	v
77	119	w
78	120	x
79	121	y
7a	122	z
7b	123	{ (Left/ Opening Brace)
7c	124	(Vertical Bar)
7d	125	} (Right/Closing Brace)
7e	126	~ (Tilde)
7f	127	DEL (Delete)

---

## Unicode Key Maps

6E	70	71	72	73	74	75	76	77	78	79	7A	7B	7C	7D	7E	•	•	•		
01	02	03	04	05	06	07	08	09	0A	0B	0C	0D	0F	4B	50	55	5A	5F	64	69
10	11	12	13	14	15	16	17	18	19	1A	1B	1C	1D	4C	51	56	5B	60	65	6A
1E	1F	20	21	22	23	24	25	26	27	28	29	2B				5C	61	66		
2C	2E	2F	30	31	32	33	34	35	36	37	39		53			5D	62	67	6C	
3A	3B	3C	3D				3E	3F	38	40	4F	54	59	63	68					

**104 Key U.S. Style Keyboard**

6E	70	71	72	73	74	75	76	77	78	79	7A	7B	7C	7D	7E	•	•	•		
01	02	03	04	05	06	07	08	09	0A	0B	0C	0D	0F	4B	50	55	5A	5F	64	69
10	11	12	13	14	15	16	17	18	19	1A	1B	1C	2B	4C	51	56	5B	60	65	6A
1E	1F	20	21	22	23	24	25	26	27	28	29	1D				5C	61	66		
2C	2D	2E	2F	30	31	32	33	34	35	36	37	39	53			5D	62	67	6C	
3A	3B	3C	3D				3E	3F	38	40	4F	54	59	63	68					

**105 Key European Style Keyboard**



# SCANNING MADE SIMPLE

---

Newland EMEA  
+31 (0) 345 87 00 33  
info@newland-id.com

Rolweg 25  
4104 AV Culemborg  
The Netherlands



@NewlandEMEA