

Magellan™ 3450VSi Omni-Directional Imaging Scanner



Product Reference Guide

Datalogic S.r.l.

Via S. Vitalino, 13
40012 Calderara di Reno — Italy
Tel. +39 051 3147011
Fax +39 051 3147205

© 2016-2019 Datalogic S.p.A. and/or its affiliates

An Unpublished Work - All rights reserved. No part of the contents of this documentation or the procedures described therein may be reproduced or transmitted in any form or by any means without prior written permission of Datalogic S.p.A. and/or its affiliates. Owners of Datalogic products are hereby granted a non-exclusive, revocable license to reproduce and transmit this documentation for the purchaser's own internal business purposes. Purchaser shall not remove or alter any proprietary notices, including copyright notices, contained in this documentation and shall ensure that all notices appear on any reproductions of the documentation.

Should future revisions of this manual be published, you can acquire printed versions by contacting your Datalogic representative. Electronic versions may either be downloadable from the Datalogic website (www.datalogic.com) or provided on appropriate media. If you visit our website and would like to make comments or suggestions about this or other Datalogic publications, please let us know via the "Contact Datalogic" page.

Disclaimer

Datalogic has taken reasonable measures to provide information in this manual that is complete and accurate, however, Datalogic reserves the right to change any specification at any time without prior notice.

Datalogic and the Datalogic logo are registered trademarks of Datalogic S.p.A. in many countries, including the U.S.A. and the E.U.

Magellan is a trademark of Datalogic S.p.A. or of Datalogic and/or its affiliates, registered in many countries, including the U.S. and the E.U.

Digimarc is a trademark of Digimarc Corporation

Patents

See www.patents.datalogic.com for patent list.



Table of Contents

- Chapter 1. GETTING STARTED**1
- About This Manual**1
 - Manual Conventions1
- Connecting the Scanner**2
- Mount Installation**5
 - Wall Mount5
 - Countertop Mount5
 - Adjustable Riser6
- Chapter 2. PROGRAMMING**.....7
- Introduction to Label Programming**7
- Understanding the Basics**7
 - Using the Programming Bar Codes7
 - Resetting the Standard Product Defaults8
 - Using a Bar Code Mask9
 - Going Green9
- Bar Code Mask**10
- GENERAL SCANNER FEATURES** 11
- 1D Double Read Timeout**12
- 2D Double Read Timeout**13
- Digital Watermark (Digimarc®) Features**14
 - Digital Watermark (Digimarc) Enable14
 - Digital Watermark (Digimarc) Double Read Timeout15
 - Digital Watermark (Digimarc) Data Format16
- Sleep Mode Timer**17
- 1D Inverse Read Control**18
- 2D Inverse Read Control**19
- Reading Illumination Duration**20
- Power On Alert**21
- Illumination During Disable Mode**22
- Object Sense Control**23
- Exposure Control**24
- External Read Indicator (ERI)**25
- ERI Timeout**26
- Good Read LED Idle State**27
- Scanner Control Button Options**28
- Good Read Beep Control**29
- Good Read Beep Frequency**30
- Good Read Beep Length**31
- Good Read Beep Volume**32
- Good Read When to Indicate**33
- Host Download to Handheld**34
 - Handheld Host Download Timeout34
- IMAGING FEATURES** 35
- Imaging Features**36
 - Image Capture to the Host by Host Command36
 - Image Capture to the Host by Camera Button37
 - Camera Button Mode37
 - Image Destination38

Cell Phone Mode	39
Cell Mode Percent	40
Picture Retrieval Timeout	41
Image Capture Delay	43
Image Format	44
Image Size	45
Image Brightness	46
Image Contrast	48
Image Compression	50
Region of Interest (ROI)	51
INTERFACE RELATED FEATURES.....	53
Interface Type	54
USB-COM Interface Setup	55
RS-232 Interface Selection	55
USB Interface Selection	56
Keyboard Interface Selection	57
Maximum Host-Transmitted Message Length	58
RS-232 Interface Features	59
RS-232 Baud Rate	59
RS-232 Number of Data Bits	61
RS-232 Number of Stop Bits	61
RS-232 Parity	62
RS-232 Hardware Control	63
RS-232 Intercharacter Delay	64
RS-232 Software Flow Control	65
RS-232 Beep on ASCII BEL	66
Beep on Not on File	66
RS-232 ACK NAK Features	67
ACK NAK Enable	67
RS-232 ACK Character	68
RS-232 NAK Character	69
RS-232 Retry on ACK NAK Timeout	70
RS-232 ACK NAK Timeout Value	71
RS-232 ACK NAK Retry Count	72
RS-232 ACK NAK Error Handling	73
RS-232 Indicate Transmission Failure	74
RS-232 Ignore Host Commands	75
USB-OEM Interface Features	76
USB OEM Scanner Device Type	76
USB OEM Additional Interface Options	77
USB Keyboard Features	78
Keyboard Layout	78
USB Keyboard Country Mode	78
USB Keyboard Caps Lock State	81
No Keyboard Support	82
USB Keyboard Send Control Characters	83
Quiet Interval	84
USB Keyboard Intercharacter Delay	85
USB Keyboard Additional Interface Options	86
DATA EDITING.....	87
Data Editing Overview	88
Please Keep In Mind...	88
Global Prefix/Suffix	89
Global Prefix	89

Global Suffix	90
AIM ID	91
Label ID	92
Label ID Control	92
Setting Label ID	93
1D Symbolologies	94
2D Symbolologies	99
Global Mid-Label ID	100
Case Conversion	101
Character Conversion	102
1D SYMBOLOGY PROGRAMMING.....	103
1D Symbolologies	103
Coupon Control	104
Coupon Control Enable	104
Coupon Label Priority Timer	105
UPC-A	106
UPC-A Enable	106
UPC-A Number System Character Transmission	107
UPC-A Check Character Transmission	108
UPC-A Minimum Read	109
Expand UPC-A to EAN-13	110
UPC-E	111
UPC-E Enable	111
UPC-E Number System Character Transmission	112
UPC-E Check Character Transmission	113
Expand UPC-E to UPC-A	114
Expand UPC-E to EAN-13	115
UPC-E Minimum Read	116
EAN-13	117
EAN-13 Enable	117
EAN-13 First Character Transmission	118
EAN-13 Check Character Transmission	119
EAN-13 ISBN Conversion Enable	120
EAN-13 Minimum Read	121
EAN-8	122
EAN-8 Enable	122
EAN-8 Check Character Transmission	123
Expand EAN-8 to EAN-13	124
EAN-8 Minimum Read	125
EAN-8 Guard Insertion	126
EAN-8 Guard Substitution	127
EAN-8/Jan-8 Both Guards Substitution	128
EAN-8 Stitch Exact Label Halves	129
EAN-8 Stitch Unlike Label Halves	130
EAN-8 Minimum Segment Length	131
EAN-8 Decoding Levels	133
Other UPC/EAN Options	134
In-Store Printed Label Minimum Read	135
UPC/EAN Correlation	136
UPC/EAN Guard Insertion	137
UPC/EAN Stitch Exact Label Halves	138
UPC/EAN Stitch Unlike Label Halves	139
UPC/EAN Minimum Segment Length	140
Price Weight Check	142
Enable EAN Two Label	144

EAN Two Label Minimum Read	145
EAN Two Label Combined Transmission	146
Add-ons	147
P2 Add-on Minimum Read	148
P5 Add-on Minimum Read	151
UPC/EAN Composites	154
GTIN	155
GTIN Enable	155
GS1 DataBar	156
DataBar Omnidirectional	156
DataBar Omnidirectional Enable	156
DataBar Omnidirectional/EAN-128 Emulation	157
DataBar Omnidirectional 2D Component Enable	158
DataBar Omnidirectional Minimum Read	159
DataBar Omnidirectional Double Read Timeout	160
DataBar Limited	162
DataBar Limited Enable	162
DataBar Limited Minimum Read	163
DataBar Limited 2D Component Enable	164
DataBar Limited EAN128 Emulation Enable	165
DataBar Expanded	166
DataBar Expanded Enable	166
DataBar Expanded EAN-128 Emulation	167
DataBar Expanded 2D Component Enable	168
DataBar Expanded Minimum Read	169
DataBar Expanded Length Control	170
DataBar Expanded Length 1	171
DataBar Expanded Length 2	172
DataBar Expanded Reverse Retry	173
Code 39	174
Code 39 Enable	174
Code 39 Start Stop Character Transmission	175
Code 39 Check Character Calculation	176
Code 39 Check Character Transmission	177
Code 39 Full ASCII	178
Code 39 Minimum Read	179
Code 39 Correlation	180
Code 39 Length Control	181
Code 39 Length 1	182
Code 39 Length 2	183
Code 39 Stitching	184
Code 39 Require Margins	185
Code 32 Italian Pharmacode	186
Code 32 Italian Pharmacode Enable	186
Code 32 Start Stop Character Transmission	187
Code 32 Check Character Transmission	188
Code 128	189
Code 128 Enable	189
Code 128 Transmit Function Characters	190
Expand Code128 to Code 39	191
Code 128 Minimum Read	192
Code 128 Correlation	193
Code 128 Length Control	194
Code 128 Length 1	195
Code 128 Length 2	196

Code 128 Stitching	197
EAN-128	198
EAN-128 Enable	198
Interleaved 2 of 5 (I 2 OF 5)	199
Interleaved 2 of 5 (I 2 OF 5) Enable	199
I 2 of 5 Check Character Calculation	200
I 2 of 5 Check Character Transmission	201
I 2 of 5 Minimum Read	202
I 2 of 5 Correlation	203
I 2 of 5 Length Control	204
I 2 of 5 Length 1	205
I 2 of 5 Length 2	206
I 2 of 5 Stitching	207
Codabar	208
Codabar Enable	208
Codabar Start Stop Character Transmission	209
Codabar Start Stop Character Set	210
Codabar Start Stop Character Match	211
Codabar Check Character Calculation	212
Codabar Check Character Transmission	213
Codabar Minimum Read	214
Codabar Correlation	215
Codabar Length Control	216
Codabar Length 1	217
Codabar Length 2	218
Codabar Stitching	219
Codabar Require Margins	220
Code 93	221
Code 93 Enable	221
Code 93 Minimum Read	222
Code 93 Correlation	223
Code 93 Length Control	224
Code 93 Length 1	225
Code 93 Length 2	226
Code 93 Stitching	227
MSI	228
MSI Enable	228
MSI Check Character Calculation	229
MSI Number of Check Characters	230
MSI Check Character Transmission	231
MSI Minimum Read	232
MSI Correlation	233
MSI Length Control	234
MSI Length 1	235
MSI Length 2	236
MSI Stitching	237
Standard 2 of 5	238
Standard 2 of 5 Enable	238
Standard 2 of 5 Check Character Calculation	239
Standard 2 of 5 Check Character Transmission	240
Standard 2 of 5 Minimum Read	241
Standard 2 of 5 Correlation	242
Standard 2 of 5 Length Control	243
Standard 2 of 5 Length 1	244
Standard 2 of 5 Length 2	245

Standard 2 of 5 Stitching	246
2D SYMBOLOGIES/BAR CODES	247
2D Codes	247
Data Matrix	248
Data Matrix Enable	248
Data Matrix Length Control	249
Configuring Variable Length Decoding:	249
Data Matrix Length 1, Length 2 Programming Instructions	250
GS1 Datamatrix Enable	251
PDF 417	252
PDF 417 Enable	252
PDF 417 Length Control	253
Configuring Variable Length Decoding:	253
PDF 417 Length 1, Length 2 Programming Instructions	254
PDF 417 Read Option	255
Micro PDF 417	256
Micro PDF 417 Enable	256
Micro PDF 417 Length Control	257
Configuring Variable Length Decoding:	257
Micro PDF 417 Length 1, Length 2 Programming Instructions	258
Micro PDF 417 128 Emulation	259
QR Code	260
QR Code Enable	260
QR Code Length Control	261
Configuring Variable Length Decoding:	261
QR Code Length 1, Length 2 Programming Instructions	262
QR Code URL Link Enable	263
GS1 QR Code Enable	264
Micro QR Code	265
Micro QR Code Enable	265
Micro QR Code Length Control	266
Configuring Variable Length Decoding:	266
Micro QR Code Length 1, Length 2 Programming Instructions	267
Aztec Code	268
Aztec Enable	268
Aztec Length Control	269
Configuring Variable Length Decoding:	269
Aztec Length 1, Length 2 Programming Instructions	270
Chapter 3. REFERENCES	271
Global Prefix/Suffix	271
Label ID	272
Length Control	273
Configuring Variable Length Decoding:	273
Length 1, Length 2 Programming Instructions	274
Appendix A. PRODUCT SPECIFICATIONS	275
Decoding Capability	275
Electrical Specifications	275
Environmental	276
Interfaces	276
Optional Features	276
Physical Characteristics	277
Scanner Dimensions	277
Reading Performance	278

Reading Ranges	278
Safety & Regulatory	278
Utilities	279
Warranty	279
LED and Beeper Indicators	279
Error Codes	281
Appendix B. CABLE PINOUTS	282
Standard Cable Pinouts (Primary Interface Cables)	282
Appendix C. ALPHA-NUMERIC KEYPAD.....	283
Appendix D. FACTORY DEFAULT SETTINGS	285
Factory Default Settings	285
Appendix E. KEYBOARD FUNCTION KEY MAPPINGS.....	299
USB Function Key Usage Map	299
Appendix F. HOST COMMANDS.....	305
Accepting RS-232 Commands	305
Appendix G. SAMPLE SYMBOLS.....	306
1D Symbol Samples	306
2D Sample Symbols	308
Composite Sample Symbols	309
Appendix H. MICROSD CARD	310
microSDHC Compatibility	311
microSD Card Insertion	311
microSD Card Removal	312
Autorun File Processing	312
microSD Function Summary	312
microSD Function Details	313
From Scanner to microSD Card	313
Capture and save an image to a microSD card by button press.	313
Export a Configuration file from the Scanner to the microSD card	313
From microSD Card to Scanner	314
Application code load to scanner	314
Configuration load to scanner	314
Appendix I. HANDHELD DATA FORMAT REQUIREMENTS	315
Handheld Data Format Requirements General	315
Datalogic Handheld Data Format Requirements	315
GS1 DataBar Omnidirectional	315
GS1 DataBar Expanded	316
UPC-A	316
UPC-A with 2-Digit Supplemental	316
UPC-A with 5-Digit Supplemental	316
UPC-E	316
UPC-E with 2-Digit Supplemental	316
UPC-E with 5-Digit Supplemental	316
EAN-8	317
EAN-8 with 2-Digit Supplemental	317
EAN-8 with 5-Digit Supplemental	317
EAN-13	317

EAN-13 with 2-Digit Supplemental	317
EAN-13 with 5-Digit Supplemental	317
Code 39	317
Code 39-Pharmacode	318
I 2 of 5	318
Codabar	318
Code 128	318
MSI	318
Code 93	319
PDF417	319
AIM Formats	319
UPC-A	319
UPC-E	319
EAN-13	319
EAN-8	319
2-Digit Supplemental	319
5-Digit Supplemental	320
Bookland	320
Code 39	320
Codabar	320
MSI	321
Code 93	321
RSS-14	321
RSS Expanded	321
I 2 of 5	321
Code 128 / EAN128	321
PDF417	322
'Unknown' AIM ID (an AIM ID which is not specified above)	322



Chapter 1

Getting Started

The Magellan™ 3450VSi On-Counter Vertical Presentation Scanner is designed for small counter retail checkout environments where there is a relatively high number of transactions with a fairly small number of items per transaction. The scanner has a reduced footprint, allowing more room for item merchandising of high margin impulse items clustered around the POS (Point of Sale).

About This Manual

This manual provides advanced user information, including connection, programming, product and cable specifications, and other useful references. For additional information, such as installation, maintenance, troubleshooting and warranty information, see the Quick Reference Guide (QRG). Copies of other publications for this product are downloadable free of charge from the website listed on the back cover of this manual.

On leaving the factory, units are programmed for the most common terminal and communications settings. If you need to change these settings, custom programming can be accomplished by scanning the bar codes in this guide. The most common default settings for features/options are indicated by a green arrow.

Manual Conventions

The symbols listed below are used in this manual to notify the reader of key issues or procedures that must be observed when using the scanner:



NOTE

Notes contain information necessary for properly diagnosing, repairing and operating the scanner.



CAUTION

The CAUTION symbol advises you of actions that could damage equipment or property.

Connecting the Scanner

The scanner kit you ordered to match your interface should provide a compatible cable for your installation. Alternatively, if your scanner receives Power Off the Terminal (POT) it might be possible to connect using a cable from a previously existing installation (except USB). For Powering Off Terminal (POT), please reference [Electrical Specifications on page 275](#) of Appendix A to ensure your Host Terminal's power supply is compatible, or contact Datalogic Technical Support. Use the instructions below when you're ready to connect the scanner to the terminal, PC or other host device.

Upon completing the connection via the appropriate interface instructions below, proceed to the section of this manual and scan the bar code to select the correct interface type.

RS-232 Serial Connection — Turn off power to the terminal/PC and connect the scanner to the terminal/PC serial port via the RS-232 cable as shown in [Figure 1](#). If the terminal will not support POT (Power Off the Terminal) to supply scanner power, use the approved power supply (AC Adapter).

Figure 1. Connecting the Scanner

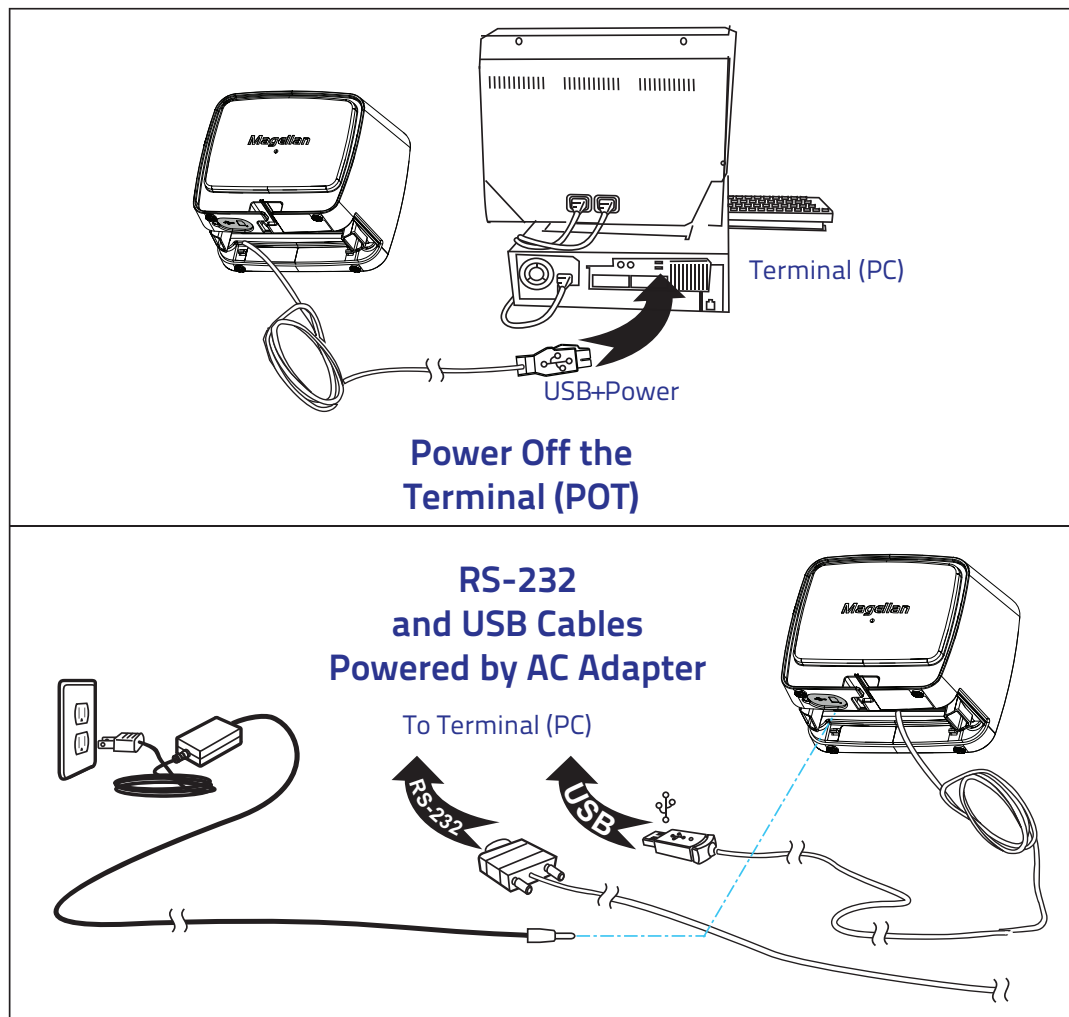

USB Connection — Connect the scanner to a USB port on the terminal/PC using the correct USB cable for the interface type you ordered. Reference [Figure 1](#) on page 2.



USB installations may require a power connection via an approved A/C Adapter as shown in [Figure 1](#). For example, this would be the case if the scanner is connected along with a number of other devices to a non-powered USB hub.

Figure 2. Scanner Features - Front View

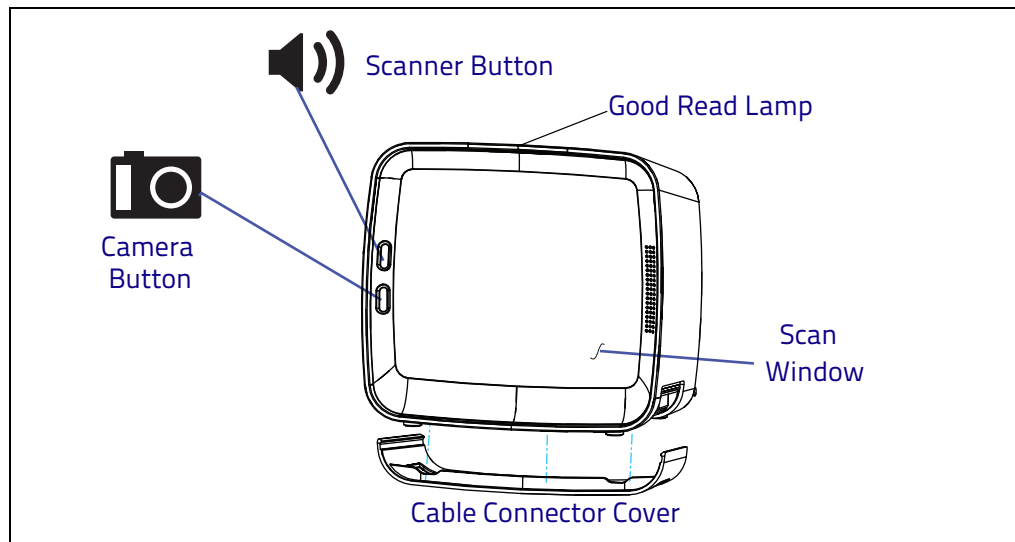

Figure 3. Scanner Features - Back View

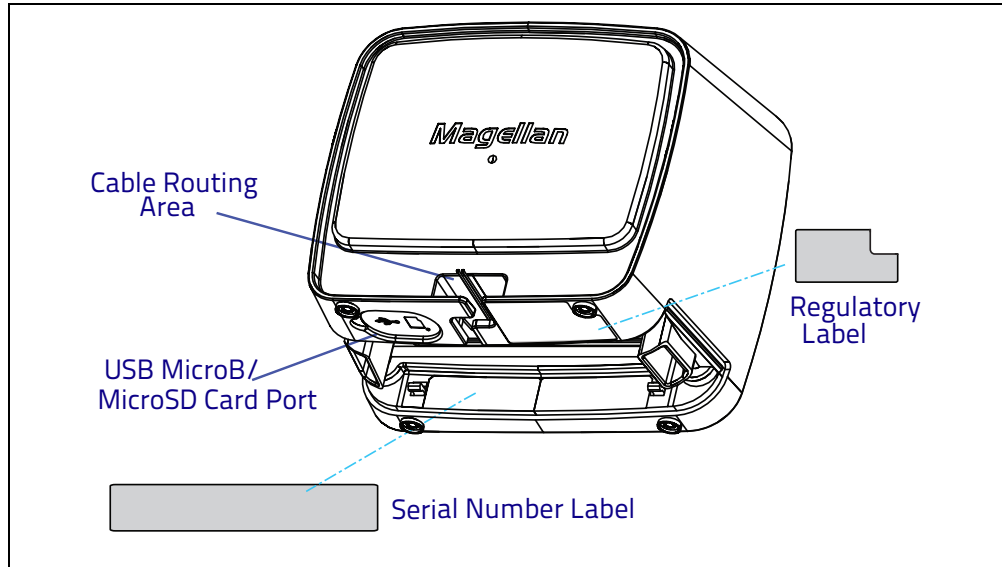
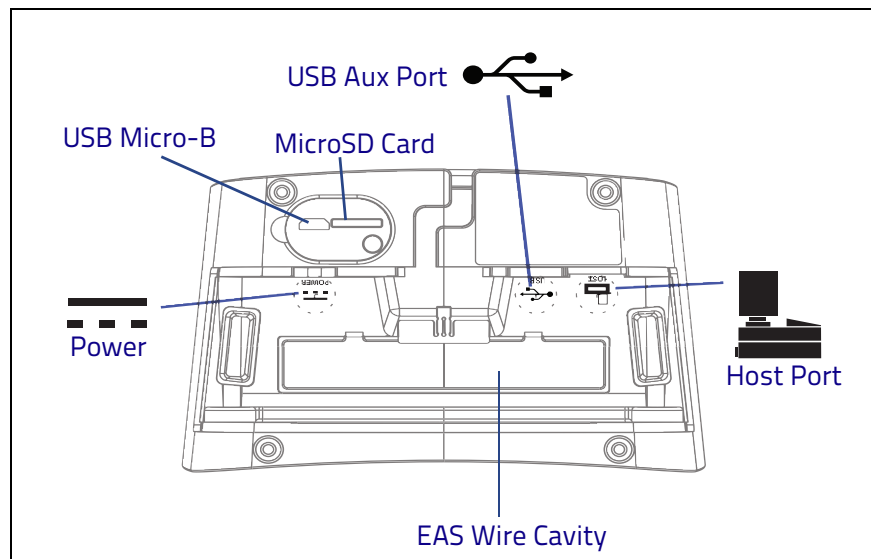

Figure 4. Scanner Features - Bottom View



Mount Installation

Options for mounting the scanner to a wall or countertop include an L-Bracket or an adjustable riser. Figure 5 shows the scanner being seated in an L-Bracket.

Figure 5. L-Bracket Mount

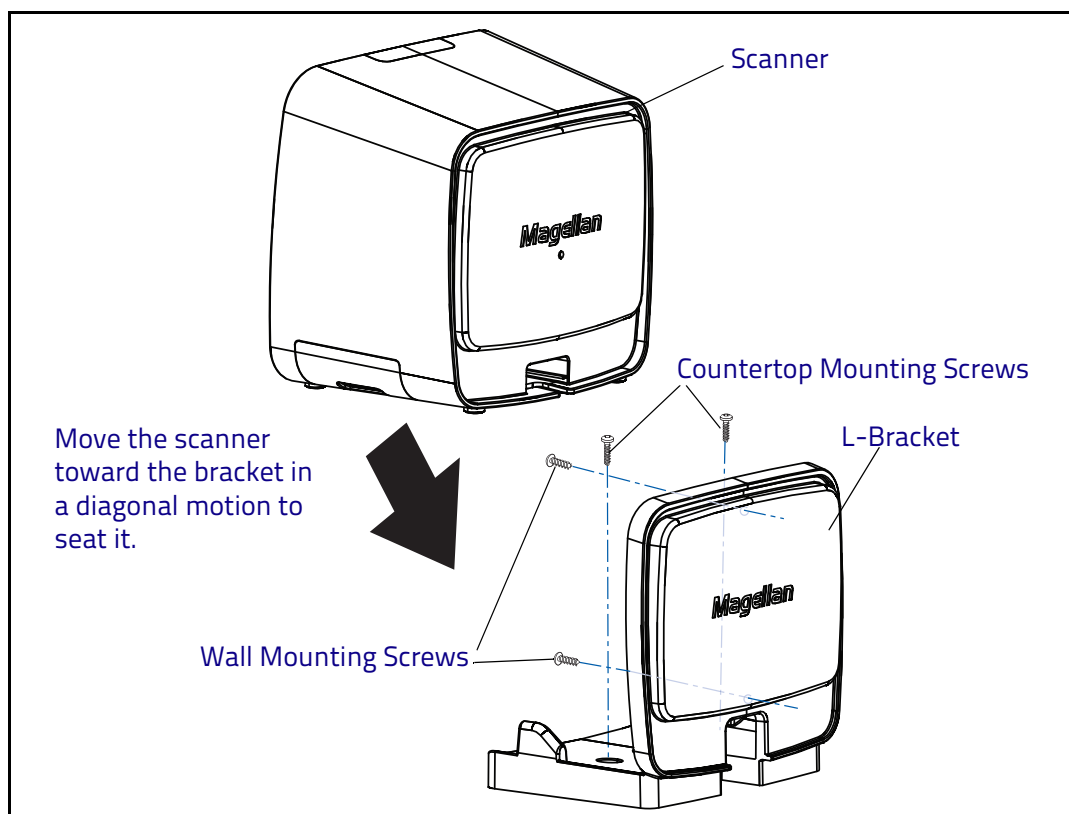

Wall Mount

Attach the L-Bracket to the wall, securing it in the desired position with two screws through the two holes in the back face of the L-Bracket as shown in Figure 5. It is recommended to use two pan head (8.2mm or 5/16" maximum head diameter) #8 screw with a thread profile that suits the mounting surface material in the wall.

Countertop Mount

If using the L-Bracket alone for countertop installation, secure the bracket in place using two screws through the bottom face of the bracket (see Figure 5). It is recommended to use two pan head (8.2mm or 5/16" maximum head diameter) #8 screw with a thread profile that suits the mounting surface material in the countertop.



Do not use a countersink type of screw head. Damage will occur from use of a countersunk screw head in the plastic screw bosses

Adjustable Riser

The Adjustable Riser may be attached as shown.

Figure 6. Using the Adjustable Riser

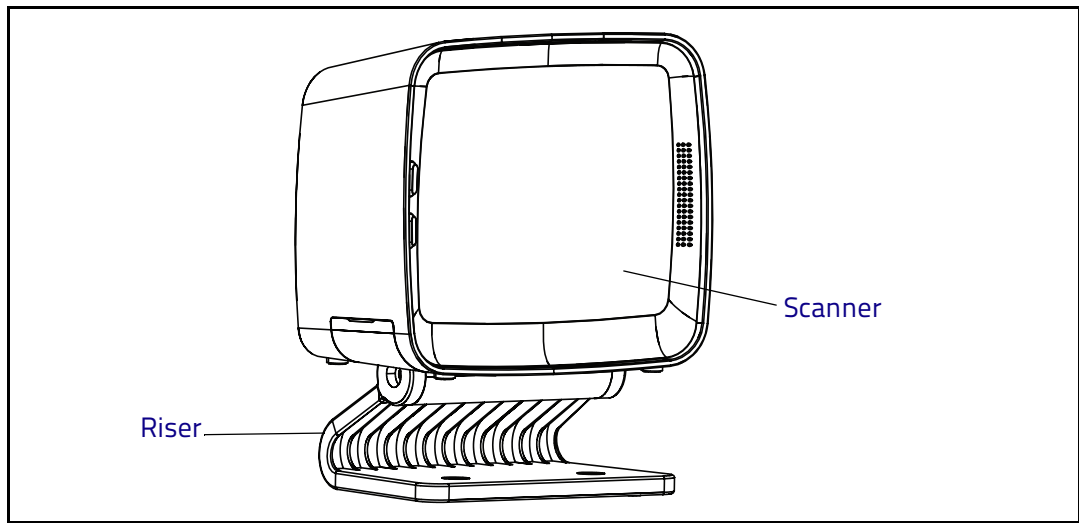



Chapter 2 Programming

Introduction to Label Programming

The programming bar code labels contained in this manual will allow you to customize and configure features and settings for your scanner. To ensure full compatibility and proper function, use only the programming bar codes in this manual and other product-specific publications to program scanner features.

This manual has been developed to make it quick and easy for users of all levels to find the information needed to understand and configure features. The following descriptions will help you to determine where to go from here.

Understanding the Basics

If you have little or no prior experience with programming using bar code labels, you should review the first few pages of this section to familiarize yourself with the basics of scanner programming before performing any changes to your configuration.

Using the Programming Bar Codes

The scanner is typically factory-configured with a set of default features standard to the interface type you ordered. After scanning the interface bar code from the section, you can select other options and customize your scanner through use of the instructions and programming bar codes available in that section and also the [Data Editing](#) and [1D Symbologies](#) chapters of this manual. This manual contains feature descriptions and bar codes which allow you to reconfigure your scanner. Some programming bar code labels, like the label below for resetting defaults, require only the scan of that single label to enact the change. Most of the programming labels in this manual, however, require the scanner to be placed in Programming Mode prior to scanning them. Scan an Enter/Exit Programming Mode bar code once to enter Programming Mode. Once the scanner is in Programming Mode, you can scan a number of parameter settings before scanning the Enter/Exit Programming Mode bar code a second time, which will then accept your changes, exit Programming Mode, reset the scanner and return it to normal operation.

Resetting the Standard Product Defaults

If you are unsure of what programming options are in your scanner, or you've changed some options and want the factory settings restored, scan the *Standard Product Default Settings* bar code below. This will copy the factory configuration for the currently active interface to the current configuration.

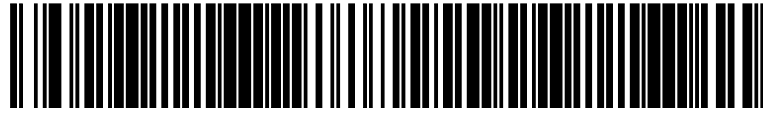

Standard Product Default Settings

The programming section lists the factory default settings for each of the menu commands for the standard RS-232 interface on the following pages, indicated by a green arrow. Exceptions to default settings for the other interfaces can be found in [Appendix D, Factory Default Settings](#).

Using a Bar Code Mask

The programming bar codes in this manual have been placed as multiples per page. In order to present them only one at a time to the scanner, a bar code mask is provided on the opposite side of this page.

Going Green

Thank you for using the bar code mask on the opposite side of this page. This manual has been formatted to minimize the quantity of pages needed to provide all of the programming bar codes available for this product.



Bar Code Mask

Cut a hole in this page and remove it from the manual as indicated to create a sleeve through which bar codes (starting in the following section) can be individually viewed and scanned, if needed. It is important that only one bar code at a time be presented to the scanner.

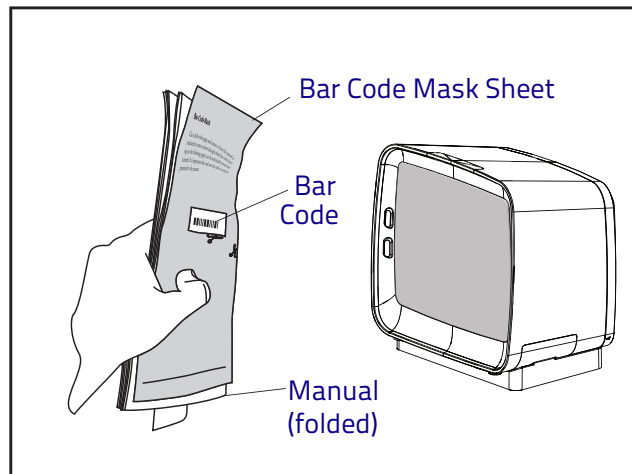
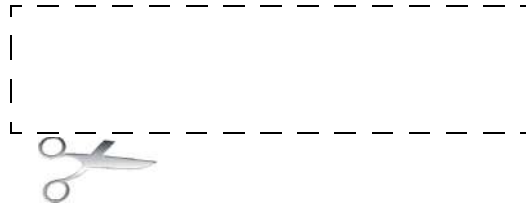



General Scanner Features

SCANNING FEATURES starting on page 12

- 1D Double Read Timeout on page 12
- 2D Double Read Timeout on page 13
- Digital Watermark (Digimarc®) Features on page 14
 - Digital Watermark (Digimarc) Enable on page 14
 - Digital Watermark (Digimarc) Double Read Timeout on page 15
 - Digital Watermark (Digimarc) Data Format on page 16
- Sleep Mode Timer on page 17
- 1D Inverse Read Control on page 18
- 2D Inverse Read Control on page 19
- Reading Illumination Duration on page 20

LED AND BEEPER INDICATORS starting on page 21

- Power On Alert on page 21
- Illumination During Disable Mode on page 22
- Object Sense Control on page 23
- Exposure Control on page 24
- External Read Indicator (ERI) on page 25
- ERI Timeout on page 26
- Good Read LED Idle State on page 27
- Scanner Control Button Options on page 28
- Good Read Beep Control on page 29
- Good Read Beep Frequency on page 30
- Good Read Beep Length on page 31
- Good Read Beep Volume on page 32
- Good Read When to Indicate on page 33

•HOST DOWNLOAD TO HANDHELD starting on page 34

- Handheld Host Download Timeout on page 34



SCANNING FEATURES

1D Double Read Timeout

The 1D Double Read Timeout feature specifies the minimum allowable time which must pass before reading the same 1D label again (e.g. two identical items in succession).

To set the Double Read Timeout:

1. Scan the Enter/Exit Programming Mode bar code.
2. Scan your selection from the bar codes below. You'll need to cover any unused bar codes on this and the facing page to ensure that the scanner reads only the bar code you intend to scan.
3. Complete the programming sequence by scanning the Enter/Exit Programming Mode bar code.



NOTE

If the incidence of multiple reads is not acceptable, increase the Double Read Timeout setting to a higher value.



1D Double Read Timeout = 300ms



1D Double Read Timeout = 400ms



1D Double Read Timeout = 600ms



1D Double Read Timeout = 800ms

2D Double Read Timeout

The 2D Double Read Timeout feature specifies the minimum allowable time which must pass before reading the same 2D label again (e.g. two identical items in succession).

To set this feature:

1. Scan the Enter/Exit Programming Mode bar code.
2. Scan your selection from the bar codes below. You'll need to cover any unused bar codes on this and the facing page to ensure that the scanner reads only the bar code you intend to scan.
3. Complete the programming sequence by scanning the Enter/Exit Programming Mode bar code.



NOTE

If the incidence of multiple reads is not acceptable, increase the Timeout setting to a higher value.



2D Double Read Timeout = 300ms



2D Double Read Timeout = 400ms



2D Double Read Timeout = 600ms

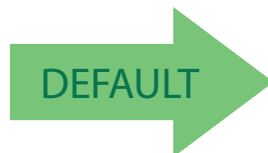

2D Double Read Timeout = 700ms



2D Double Read Timeout = 800ms

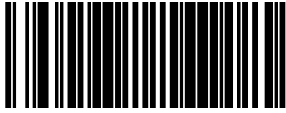

Digital Watermark (Digimarc®) Features

Digital Watermark (Digimarc) Enable

Enables/Disables the ability of the scanner to decode Digimarc® Digital Watermarks.

To set this feature:

1. Scan the Enter/Exit Programming Mode bar code.
2. Scan your selection from the bar codes below. You'll need to cover any unused bar codes on this and the facing page to ensure that the scanner reads only the bar code you intend to scan.
3. Complete the programming sequence by scanning the Enter/Exit Programming Mode bar code.



NOTE

The Digimarc Digital Watermark feature requires the purchase of a special software license to activate it. For more information, please contact your Datalogic representative.



Digital Watermark (Digimarc) = Disable



Digital Watermark (Digimarc) = Enable



Digital Watermark (Digimarc) Double Read Timeout

Specifies the minimum allowable time which must pass before reading the same Digital Watermark (Digimarc) label again (e.g. two identical items in succession).

To set this feature:

1. Scan the Enter/Exit Programming Mode bar code.
2. Scan your selection from the bar codes below. You'll need to cover any unused bar codes on this and the facing page to ensure that the scanner reads only the bar code you intend to scan.

Complete the programming sequence by scanning the Enter/Exit Programming Mode bar code.



If the incidence of multiple reads is not acceptable, increase the Double Read Timeout setting to a higher value.



Digimarc Double Read Timeout = 0.3 Seconds



Digimarc Double Read Timeout = 0.4 Seconds

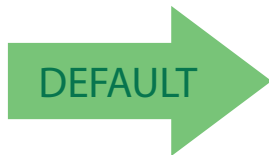

Digimarc Double Read Timeout = 0.5 Seconds



Digimarc Double Read Timeout = 0.7 Seconds



Digimarc Double Read Timeout = 1 Second

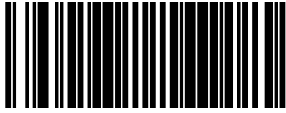

Digital Watermark (Digimarc) Data Format

Selects the format for the watermark data. Choices are:

- Compatibility mode
- Databar-14
- Native

1. Scan the Enter/Exit Programming Mode bar code.
2. Scan your selection from the bar codes below. You'll need to cover any unused bar codes on this and the facing page to ensure that the scanner reads only the bar code you intend to scan.
3. Complete the programming sequence by scanning the Enter/Exit Programming Mode bar code.



NOTE

The Digital Watermark feature must be enabled for decode functionality.

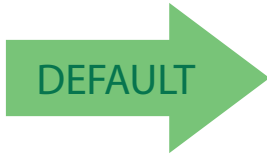

Digital Watermark (Digimarc) Data Format = Compatibility mode



Digital Watermark (Digimarc) Data Format = Databar-14 mode



Digital Watermark (Digimarc) Data Format = Native mode

Sleep Mode Timer

This feature specifies the amount of time of inactivity (with no label reads) before the scanner enters sleep mode.

To set this feature:

1. Scan the Enter/Exit Programming Mode bar code.
2. Scan the bar code, [Set Sleep Mode Timer on page 17](#) below. You'll need to cover any unused bar codes on this and the facing page to ensure that the scanner reads only the bar code you intend to scan.
3. Scan the appropriate digits from the [Alpha-Numeric Keypad in Appendix C](#) that represent the desired time interval. The selectable range is 000–255 in 15 second increments. Pad all numbers with leading zeros to yield a three-digit entry (000–255).
4. Scan the Enter/Exit Programming Mode bar code to exit Programming Mode.



Set Sleep Mode Timer

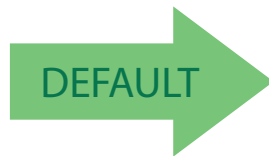

Default setting for this feature is: 5 minutes

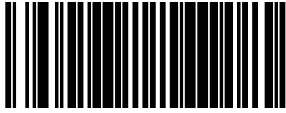

1D Inverse Read Control

This configuration item is used to toggle inverted label reading for 1D bar codes, for example, a label printed as white on black as opposed to black on white.

To set this feature:

1. Scan the Enter/Exit Programming Mode bar code.
2. Scan your selection from the bar codes below. You'll need to cover any unused bar codes on this and the facing page to ensure that the scanner reads only the bar code you intend to scan.
3. Complete the programming sequence by scanning the Enter/Exit Programming Mode bar code.

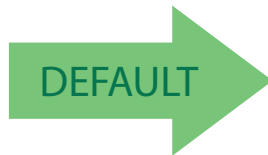

1D Inverse Read Control = Enable



1D Inverse Read Control = Disable

2D Inverse Read Control

This configuration item is used to toggle inverted label reading for 2D bar codes, for example, a label printed as white on black as opposed to black on white.

To set this feature:

1. Scan the Enter/Exit Programming Mode bar code.
2. Scan your selection from the bar codes below. You'll need to cover any unused bar codes on this and the facing page to ensure that the scanner reads only the bar code you intend to scan.
3. Complete the programming sequence by scanning the Enter/Exit Programming Mode bar code.



2D Inverse Read Control = Disable



2D Inverse Read Control = Enable

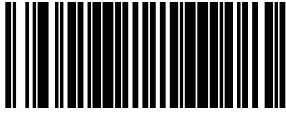

Reading Illumination Duration

This feature specifies how long the illumination stays on after a label or label segment is read.

To set this feature:

1. Scan the Enter/Exit Programming Mode bar code.
2. Scan your selection from the bar codes below. You'll need to cover any unused bar codes on this and the facing page to ensure that the scanner reads only the bar code you intend to scan.
3. Complete the programming sequence by scanning the Enter/Exit Programming Mode bar code.



Reading Illumination Duration = 1 Seconds



Reading Illumination Duration = 3 Seconds

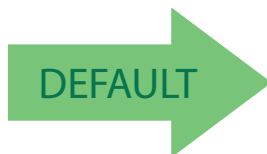

Reading Illumination Duration = 5 Seconds

LED AND BEEPER INDICATORS

Power On Alert

Disables or enables the indication that the scanner has finished all its power up tests and is now ready for operation (usually a single beep).



NOTE

This feature is configurable so the beep can be replaced with a .wav file.



Power-up Tone Control = No Tone



Power-up Tone Control = Play Tone



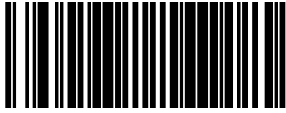

Illumination During Disable Mode

This feature allows illumination to be turned off when the scanner is in “disable” mode. It determines if the imager illumination is controlled by host interface enable/disable commands.

Disable = Illumination is not controlled by host enable/disable commands, illumination stays on when disabled.

Enable = Illumination is controlled by host enable/disable commands, illumination is on when enabled and off when disabled.

To set this feature:

1. Scan the Enter/Exit Programming Mode bar code.
2. Scan your selection from the bar codes below.
3. Complete the programming sequence by scanning the Enter/Exit Programming Mode bar code.



Illumination During Disable Mode = Disable



Illumination During Disable Mode = Enable



Object Sense Control

This feature determines whether the main illumination is controlled by the Object Sensing system, or alternatively, stays continuously on.

Enable = Illumination is controlled by using Object Sense

Disable = Normal illumination is used but it goes off during sleep mode / disable mode

To set this feature:

1. Scan the Enter/Exit Programming Mode bar code.
2. Scan your selection from the bar codes below. You'll need to cover any unused bar codes on this and the facing page to ensure that the scanner reads only the bar code you intend to scan.
3. Complete the programming sequence by scanning the Enter/Exit Programming Mode bar code.

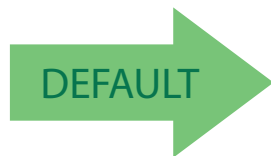

Object Sense Control = Enable



Object Sense Control =Disable



Exposure Control

This feature controls the depth of field through exposure adjustment. Contact Customer Support for more details about this feature.

To set this feature:

1. Scan the Enter/Exit Programming Mode bar code.
2. Scan your selection from the bar codes below. You'll need to cover any unused bar codes on this and the facing page to ensure that the scanner reads only the bar code you intend to scan.
3. Complete the programming sequence by scanning the Enter/Exit Programming Mode bar code.



Short depth of field



Medium depth of field

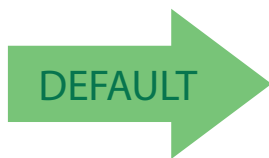

Long depth of field

External Read Indicator (ERI)



NOTE

This feature is available only through use of a special cable.

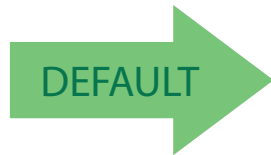

ERI Active State = Active Low



ERI Active State = Active High



ERI Timeout

Specifies the amount of time the External Read Indicator (ERI) signal is held active for a good read. Sets the ERI timeout duration using hex values from 000 to 255 in increments of ten milliseconds (10ms or 0.01 seconds).

To configure this feature:

1. Scan the “Enter/Exit Programming Mode” bar code above to place the unit in Programming Mode.
2. Scan “Set ERI Timeout,” followed by the two digits (zero padded) from the [Alpha-Numeric Keypad in Appendix C](#) representing the desired time value.
3. Exit programming mode by scanning the “Enter/Exit Programming Mode” bar code again.



Set ERI Timeout



Default setting for this feature is:
002 -20ms

Good Read LED Idle State

This feature specifies the state of the green scanner LEDs when the scanner is idle and ready to read a label. Options are:

- Off
- On dim

To set the Scanner LEDs Idle State:

1. Scan the Enter/Exit Programming Mode bar code.
2. Scan your selection from the bar codes below. You'll need to cover any unused bar codes on this and the facing page to ensure that the scanner reads only the bar code you intend to scan.
3. Complete the programming sequence by scanning the Enter/Exit Programming Mode bar code.



Scanner LED Idle State = Off



Scanner LED Idle State = On Dim



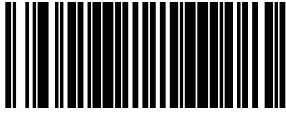

Scanner Control Button Options

Configure the Scanner Control Button to one of the following modes of operation:

- Enable all functions: Volume, tone, diagnostics and reset.
- Enable only volume, tone and reset.
- Enable reset only.
- Disable all button functions

To set the desired Scanner Control Button Option:

1. Scan the Enter/Exit Programming Mode bar code.
2. Scan your selection from the bar codes below. You'll need to cover any unused bar codes on this and the facing page to ensure that the scanner reads only the bar code you intend to scan.
3. Complete the programming sequence by scanning the Enter/Exit Programming Mode bar code.



Scanner Control Button = Enable All Functions



Scanner Control Button = Enable Only Volume Tone and Reset



Scanner Control Button = Enable Reset Only



Scanner Control Button = Disable All Functions

Good Read Beep Control

This feature enables/disables scanner beep upon successfully decoding of a label.

To set this feature:

1. Scan the Enter/Exit Programming Mode bar code.
2. Scan your selection from the bar codes below. You'll need to cover any unused bar codes on this and the facing page to ensure that the scanner reads only the bar code you intend to scan.
3. Complete the programming sequence by scanning the Enter/Exit Programming Mode bar code.



Good Read Beep Control = Disable



Good Read Beep Control = Enable





Good Read Beep Frequency

Adjusts the scanner's good read beep to sound at low, medium, or high frequency (controls the beeper's pitch/tone).

- Low
- Medium
- High

To set this feature:

1. Scan the Enter/Exit Programming Mode bar code.
2. Scan your selection from the bar codes below. You'll need to cover any unused bar codes on this and the facing page to ensure that the scanner reads only the bar code you intend to scan.
3. Complete the programming sequence by scanning the Enter/Exit Programming Mode bar code.



Good Read Beep Frequency = Low



Good Read Beep Frequency = Medium



Good Read Beep Frequency = High

Good Read Beep Length

Specifies the duration of a good read beep.

To set this feature:

1. Scan the Enter/Exit Programming Mode bar code.
2. Scan the bar code, [Set Good Read Beep Length on page 31](#). You'll need to cover any unused bar codes on this and the facing page to ensure that the scanner reads only the bar code you intend to scan.
3. Scan the appropriate digits from the [Alpha-Numeric Keypad in Appendix C](#) that represent the desired good read beep length setting. The selectable range is 1–255, which is the timeout in 10–millisecond increments. Times have a tolerance of $\pm 25\%$. Pad all single and double digit numbers with leading zeroes to yield a three–digit entry (001–255).

Examples:

001 = 10ms

005 = 50ms

040 = 400ms

4. The scanner will automatically exit Programming Mode when the appropriate amount of digits have been scanned.



Set Good Read Beep Length

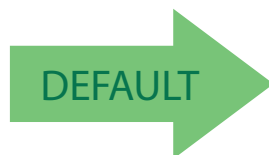

Default setting for this feature is:
008 - 80ms

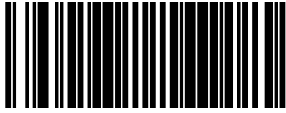

Good Read Beep Volume

Selects the beeper volume upon a good read beep. There are five selectable volumes, with each volume increment adding approximately five decibels to the previous level:

- Low
- Medium Low
- Medium
- Medium High
- High

To set this feature:

1. Scan the Enter/Exit Programming Mode bar code.
2. Scan your selection from the bar codes below. You'll need to cover any unused bar codes on this and the facing page to ensure that the scanner reads only the bar code you intend to scan.
3. Complete the programming sequence by scanning the Enter/Exit Programming Mode bar code.



Good Read Beep Volume = Low

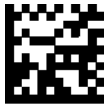

Good Read Beep Volume = Medium Low

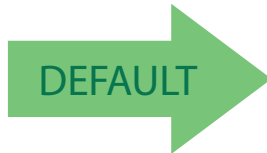

Good Read Beep Volume = Medium



Good Read Beep Volume = Medium High



Good Read Beep Volume = High

Good Read When to Indicate

This feature specifies when the scanner will provide indication (beep and/or flash its green LEDs) upon successfully reading a bar code.

- Good Read = Indicate after decode.
- Good Read = Indicate after transmit.
- Good Read = Indicate after CTS goes inactive, then active.
This mode applies to RS-232 STD and RS-232 WN interfaces only. If set in other interfaces, “Indicate after decode” mode will be implemented.
- Good Read = Indicate after each output structure proofed.
When beeping after each output structure decoded, if there are multiple output structures, there is a delay after the beep has finished. This delay is equal to the [Good Read Beep Length on page 31](#).

To set the Good Read When to Indicate feature:

1. Scan the Enter/Exit Programming Mode bar code.
2. Scan the desired mode bar code from those provided below You’ll need to cover any unused bar codes on facing pages to ensure that the scanner reads only the bar code you intend to scan.
3. Complete the programming sequence by scanning the Enter/Exit Programming Mode bar code.

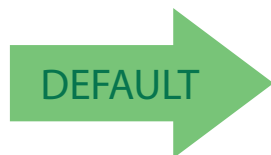

Good Read When to Indicate = After Decode



Good Read When to Indicate = After Transmit



Good Read When to Indicate = After CTS goes Inactive,
Then Active



Good Read When to Indicate = After Each Output
Structure Proofed



Host Download to Handheld

Attached Datalogic handheld scanners can be updated via the host port. Contact Technical Support for details.

Handheld Host Download Timeout

This feature sets the timeout (in seconds) to wait for a response from the handheld when performing a host download to the handheld.

To set this feature:

1. Scan the Enter/Exit Programming Mode bar code.
2. Scan the bar code below, Set Handheld HDL Timeout. You'll need to cover any unused bar codes on this and the facing page to ensure that the scanner reads only the bar code you intend to scan.
3. Scan the appropriate digits from the [Alpha-Numeric Keypad in Appendix C](#) that represent the desired delay. The selectable range is 001–255, which is the delay in 1-second increments. Pad all single and double digit numbers with leading zeroes to yield a three-digit entry (001–255).
4. Complete the programming sequence by scanning the Enter/Exit Programming Mode bar code.

Examples:

002 = 2 seconds

005 = 5 seconds

015 = 15 seconds



Set Handheld HDL Timeout

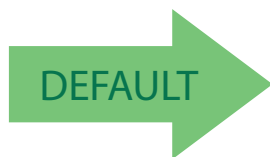

Default setting for this feature is: 15 seconds



Imaging Features

IMAGING FEATURES starting on page 36

- Image Capture to the Host by Host Command on page 36
- Image Capture to the Host by Camera Button on page 37
 - Camera Button Mode on page 37
 - Image Destination on page 38
- Cell Phone Mode on page 39
- Cell Mode Percent on page 40
- Picture Retrieval Timeout on page 41
- Image Capture Delay on page 43
- Image Format on page 44
- Image Size on page 45
- Image Brightness on page 46
- Image Contrast on page 48
- Image Compression on page 50
- Region of Interest (ROI) on page 51



Imaging Features

Image Capture to the Host by Host Command

This feature is only available for RS-232 and USB COM interfaces.



NOTE

If the USB COM interface has been selected, follow the instructions in USB-COM Interface Setup on page 55.

The host command format is as follows:

P<cnt>pSBC

where:

P - ASCII 'P' used as preamble of pass-through commands

<cnt> - binary value of 4 indicating 4 bytes to follow

p - ASCII lowercase 'p' ; command to take a picture

S - size value of image as ASCII character

'S' == uses scanner's configuration value

'0'-VGA, (640X480)

'1'-WVGA, (752X480)

'2'-SXGA, (1280x1027)

'3'-CIF (320x240)

B - brightness value in ASCII

'B' == uses scanner's configuration value CI_IMAGE_BRIGHTNESS
else '0' thru'9' specifies brightness

C - contrast value in ASCII

'C' == uses scanner configuration value CI_IMAGE_CONTRAST
else '0' thru'9' specifies contrast

IF the image is of a type the scanner supports, capture and transmission occurs,
and the command is of proper format

THEN

The scanner will transmit an ACK (0x06) to the Host in response to this command.

The image data transmission starts with a 4 byte binary field representing (Big Endian) number of bytes to follow.

If the "number of bytes to follow" value is zero, there was a problem with generating the image and the request should be retried.

ELSE

The scanner will transmit a BEL (0x07) to the Host in response to this command.

ENDIF

Image Capture to the Host by Camera Button

Perform the following steps to set up the Camera Button.

1. Set the Camera Button Mode to enabled.
2. Set the Image Capture destination to host port.
3. Press the camera button.

Scanner will beep for a few seconds, then take picture and send the Image Retrieval Event label to the POS to indicate image is ready. The data content of the event label is:

A856102000239

The POS sends the picture retrieval command to initiate picture download from the scanner. Format of the command is:

P\x02pG

The scanner sends the picture to the POS with the transmission format described in the previous section, "Image Capture By Host Command".

Camera Button Mode

This feature enables or disables the camera button.



Camera Button Mode = Disabled



Camera Button Mode = Enable

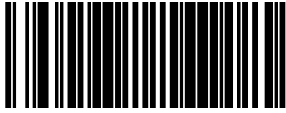

Image Destination

Specifies the destination for pictures/images taken with a camera button press.

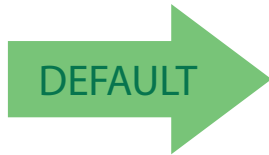

Image Destination = Disable



Image Destination = SD card^a



Image Destination = Host port

- a. Contact Customer Service for more information on using this feature.

Cell Phone Mode

Enables/disables the operating mode for mobile phone read.

When cell phone mode is enabled, the scanner stays on regardless of host command or button push. It will not enter sleep mode.



Cell Phone Mode = Enable (Always On)



Cell Phone Mode = Disable





Cell Mode Percent

Specifies the rate of frames dedicated to reading cell phones. Cell reading feature must be enabled for this to be active. The setting reflects a variable setting (or percentage) of frames dedicated to cell reading



As the percentage is increased, object sense (if enabled) will become less responsive. Anything above 10% will have a negative impact on scanning performance.

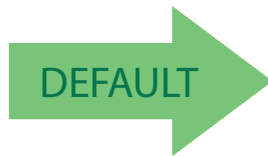

Cell Mode Percent = 2.5% (Very Low)



Cell Mode Percent = 5% (Low)



Cell Mode Percent = 10% (Medium)



Cell Mode Percent = 20% (Medium High)



Cell Mode Percent = 50% (High)

Picture Retrieval Timeout

This feature sets the amount of time after the picture retrieval label is sent to the POS that the scanner will allow subsequent picture taking requests via button press.



NOTE

If set to 0, the picture retrieval timeout will not be used and a picture will remain accessible until another is taken or the scanner is reset.



Picture Retrieval Timeout = 0



Picture Retrieval Timeout = 1 second



Picture Retrieval Timeout = 2 seconds



Picture Retrieval Timeout = 3 seconds



Picture Retrieval Timeout = 4 seconds

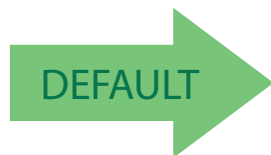

Picture Retrieval Timeout = 5 seconds



Picture Retrieval Timeout (continued)



Picture Retrieval Timeout = 6 seconds



Picture Retrieval Timeout = 7 seconds



Picture Retrieval Timeout = 8 seconds



Picture Retrieval Timeout = 9 seconds



Picture Retrieval Timeout = 10 seconds

Image Capture Delay

This feature specifies the amount of time after the image capture is initiated by a button press until the picture is taken.



Image Capture Delay = 0 seconds



Image Capture Delay = 1 second



Image Capture Delay = 2 seconds

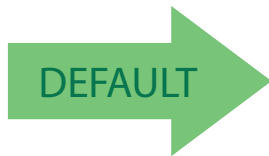

Image Capture Delay = 5 seconds



Image Capture Delay = 10 seconds

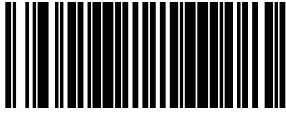

Image Format

This feature specifies the output format for images taken using the camera function of the scanner.

Choices are:

- JPG
- BMP

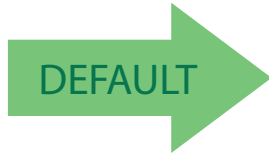

Image Format = JPG



Image Format = BMP

Image Size

This feature specifies the size of the captured image. Choices are:

VGA — Video Graphics Array. 640 x 480 pixels.

WVGA. Wide Video Graphics Array, various physical sizes, 16:9 shape

Full Size. Maximum image height and width. Largest image.

Half VGA. Half of the size of a regular VGA image, 320 x 240 pixels. Smallest image.

Scaled VGA. Video Graphics Array, 640 x 480 pixels.

ROI. The size of an ROI image is determined by the value of the ROI setting. See "Region of Interest (ROI)" on page 51.

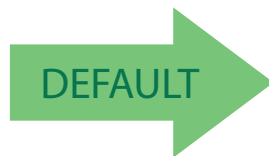

Image Size = VGA



Image Size = WVGA



Image Size = Full Size



Image Size = Half VGA



Image Size = Scaled VGA



Image Size = ROI



Image Brightness

Specifies the image brightness value. The selectable range is from 0 to 10, with 10 being the brightest.



Image Brightness = 0



Image Brightness = 1



Image Brightness = 2



Image Brightness = 3



Image Brightness = 4



Image Brightness = 5



Image Brightness = 6



Image Brightness = 7

Image Brightness (continued)



Image Brightness = 8



Image Brightness = 9



Image Brightness = 10



Image Contrast

This feature sets the contrast level for a captured image. The selectable range is from 0 to 10, with 0 being the lowest and 10 being the highest contrast.



Image Contrast = 0



Image Contrast = 1



Image Contrast = 2



Image Contrast = 3



Image Contrast = 4



Image Contrast = 5



Image Contrast = 6



Image Contrast = 7

Image Contrast (continued)



Image Contrast = 8



Image Contrast = 9



Image Contrast = 10



Image Compression

Specifies the starting image compression factor.



Image Compression = 5



Image Compression = 10



Image Compression = 25



Image Compression = 50



Image Compression = 70



Image Compression = 80



Image Compression = 90

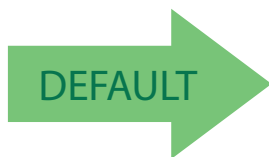
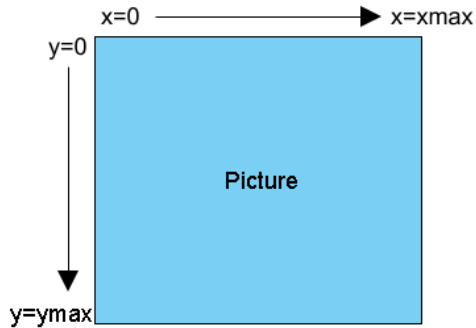

Image Compression = 100

Region of Interest (ROI)

This feature specifies the X-Y coordinates for the Region of Interest (ROI). The region of interest coordinates are defined as follows:



Where **xmax** is the x-size of a full size image (1279 pixels), and **ymin** is the y-size of a full size image (1023 pixels).

For example, a coordinate set of 0, 639, 512, 1023 will produce the bottom left section of a full size image.



Picture coordinates are NOT defined on a Cartesian coordinate plane.

NOTE

- Byte [0]-[1]: 16 bit hex value xmin
- Byte [2]-[3]: 16 bit hex value xmax
- Byte [4]-[5]: 16 bit hex value ymin
- Byte [6]-[7]: 16 bit hex value ymax



NOTES

If the xmax/ymax values are configured larger than the maximum values above, they will default to 1 less than their respective maximum values.

If the xmin/ymin values are configured larger than xmax/ymax, they will default to 0.

Images extracted with ROI must be in JPG format.

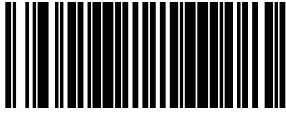

Region of Interest (continued)

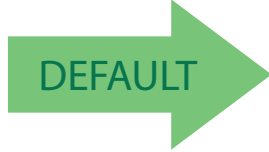

Region of Interest = default



Region of Interest = upper left quadrant



Region of Interest = upper right quadrant



Region of Interest = lower left quadrant



Region of Interest = lower right quadrant



Interface Related Features

USB-COM INTERFACE SETUP starting on page 55

- USB-COM Interface Setup on page 55
- RS-232 Interface Selection on page 55
- USB Interface Selection on page 56
- Keyboard Interface Selection on page 57
- Maximum Host-Transmitted Message Length on page 58

RS-232 INTERFACE FEATURES starting on page 59

RS-232 Interface Features on page 59

- RS-232 Baud Rate on page 59
- RS-232 Number of Data Bits on page 61
- RS-232 Number of Stop Bits on page 61
- RS-232 Parity on page 62
- RS-232 Hardware Control on page 63
- RS-232 Intercharacter Delay on page 64
- RS-232 Software Flow Control on page 65
- RS-232 Beep on ASCII BEL on page 66
- Beep on Not on File on page 66
- RS-232 ACK NAK Features on page 67
 - ACK NAK Enable on page 67
 - RS-232 ACK Character on page 68
 - RS-232 NAK Character on page 69
 - RS-232 Retry on ACK NAK Timeout on page 70
 - RS-232 ACK NAK Timeout Value on page 71
 - RS-232 ACK NAK Retry Count on page 72
 - RS-232 ACK NAK Error Handling on page 73
- RS-232 Indicate Transmission Failure on page 74
- RS-232 Ignore Host Commands on page 75

USB-OEM INTERFACE FEATURES starting on page 76

- USB OEM Scanner Device Type on page 76

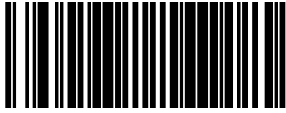

- USB KEYBOARD FEATURES** starting on page 78
- Keyboard Layout on page 78
 - USB Keyboard Country Mode on page 78
 - USB Keyboard Caps Lock State on page 81
 - No Keyboard Support on page 82
 - USB Keyboard Send Control Characters on page 83
 - Quiet Interval on page 84
 - USB Keyboard Intercharacter Delay on page 85
 - USB Keyboard Additional Interface Options on page 86

INTERFACE SELECTION

Interface Type

Specifies the current scanner interface.



NOTE

The correct interface cable is generally included for the reader interface type you ordered.



NOTE

If the scanner's interface type must be changed, always be sure that interface configuration is the **FIRST** item scanned during a programming session. (Selecting an interface type resets **ALL** other configuration items to the factory default for that interface type.)



CAUTION

Great care should be taken to select the correct interface type, since you can cause damage to the scanner and/or POS terminal by attempting to change to an incompatible interface. **ALWAYS** make interface selections with the host cable **DISCONNECTED**.



NOTE

When an interface is selected, the scanner loads the configuration for that interface as the selection is made. Any custom configurations done in the previous interface will not be carried over to the configuration for the new interface.

USB-COM Interface Setup

Before plugging your scanner into the Host PC, please ensure you have already copied the executable DLS USB-COM driver file to your PC and that the scanner's interface is set to USB COM. The DLS USB-COM driver (for Windows operating systems) is provided by Datalogic or downloaded from the Datalogic website.

1. Execute the DLS USB-COM driver file.
2. When the scanner is first plugged into the PC, Windows will bring up the "Found New Hardware" message.
3. The installation is complete.



NOTE

Contact your Datalogic Representative for information about USB-COM operation with other major PC operating systems.

RS-232 Interface Selection

Remember to cover any unused bar codes on this and the facing page to ensure that the scanner reads only the bar code you intend to scan.



CAUTION

Great care should be taken to select the correct interface type, since you can cause damage to the scanner and/or POS terminal by attempting to change to an incompatible interface. ALWAYS make interface selections with the host cable DISCONNECTED.



Interface Type = RS-232 Standard



Interface Type = RS-232 Wincor-Nixdorf



USB Interface Selection

Remember to cover any unused bar codes on this and the facing page to ensure that the scanner reads only the bar code you intend to scan.



CAUTION

Great care should be taken to select the correct interface type, since you can cause damage to the scanner and/or POS terminal by attempting to change to an incompatible interface. ALWAYS make interface selections with the host cable DISCONNECTED.



Interface Type = USB OEM



Interface Type = USB TEC



Interface Type = USB COM

Keyboard Interface Selection

Remember to cover any unused bar codes on this and the facing page to ensure that the scanner reads only the bar code you intend to scan.



CAUTION

Great care should be taken to select the correct interface type, since you can cause damage to the scanner and/or POS terminal by attempting to change to an incompatible interface. ALWAYS make interface selections with the host cable DISCONNECTED.



Interface Type = USB Keyboard



INTERFACE FEATURES

Maximum Host-Transmitted Message Length

Specifies the maximum number of data characters allowed in messages transmitted to the host.

To set the Maximum Host-Transmitted Message Length:

1. Scan the Enter/Exit Programming Mode bar code.
2. Scan the bar code, [Set Maximum Host-Transmitted Message Length on page 58](#) below. You'll need to cover any unused bar codes on this and the facing page to ensure that the scanner reads only the bar code you intend to scan.
3. Scan the appropriate digits from the [Keypad on page 461](#) in [Appendix C](#) that represent the desired maximum host-transmitted message length. The selectable range is 0-249 data characters. (Labels that are longer than this length are not read.) Pad all single and double digit numbers with leading zeroes to yield a three-digit entry (000-249).



NOTE

If this configuration item is set to 0 (000), there is no general length limit imposed on data being transmitted to the host.

4. The scanner will automatically exit Programming Mode when the appropriate amount of digits have been scanned.



Set Maximum Host-Transmitted Message Length

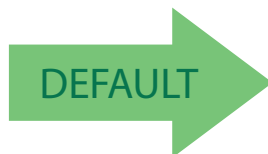

Default setting for this feature is:
000 - No general limit imposed

RS-232 Interface Features



NOTE

A setting of no parity with 7 data bits is invalid and will default to 8 data bits and no parity.

RS-232 Baud Rate



RS-232 Baud Rate = 1200



RS-232 Baud Rate = 2400



RS-232 Baud Rate = 4800



RS-232 Baud Rate = 9600



RS-232 Baud Rate = 19200



RS-232 Baud Rate = 38400

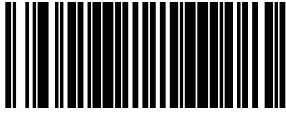

RS-232 Baud Rate (continued)



RS-232 Baud Rate = 57600



RS-232 Baud Rate = 115200



RS-232 Baud Rate = 230400

RS-232 Number of Data Bits

Specifies number of data bits required for sending and receiving data..



NOTE

A setting of 7 data bits with no parity will default to 8 data bits and no parity.



RS-232 Number of Data Bits = 7



RS-232 Number of Data Bits = 8



RS-232 Number of Stop Bits

Specifies number of stop bits required for sending and receiving data

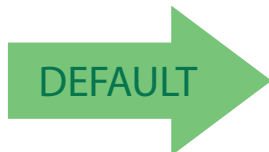

RS-232 Number of Stop Bits = 1



RS-232 Number of Stop Bits = 2

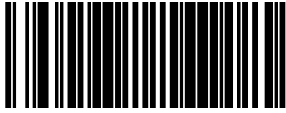

RS-232 Parity

Specifies parity required for sending and receiving data.

Options for this setting are:

- RS-232 PARITY = NONE
- RS-232 PARITY = EVEN
- RS-232 PARITY = ODD.



NOTE

A setting of no parity with 7 data bits will default to 8 data bits and no parity.

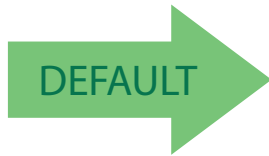

RS-232 Parity = None



RS-232 Parity = Even



RS-232 Parity = Odd

RS-232 Hardware Control

Enables/disables use of the RS-232 CTS signal for flow control and/or scan control.

Options are:

- **Disable** — The scanner transmits to the host regardless of any activity on the CTS line.
- **Enable CTS Flow Control** — The CTS signal controls transmission of data to the host.
- **Enable CTS Scan Control** — The CTS line must be active for scanner to read and transmit data. While the CTS line is inactive, scanner remains in a host-disabled state; following a successful label transmission, the CTS signal must transition to inactive and then to active to enable scanning for the next label.
- **Enable Magellan SL CTS Scan Control** — Follows the same hardware protocol as older Magellan SL scanners.

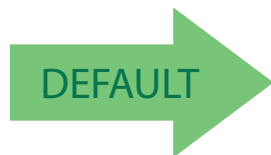

RS-232 Hardware Control = Disable



RS-232 Hardware Control = Enable CTS Flow Control



RS-232 Parity = Enable CTS Scan Control



RS-232 Hardware Control = Enable MGL SL CTS Scan Control

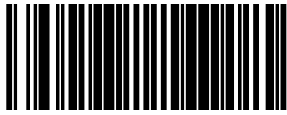

RS-232 Intercharacter Delay

Specifies delay between the end of one character and the beginning of the next in 10-millisecond increments. This delay is inserted after each data character transmitted. If the transmission speed is too high, the system may not be able to receive all characters. You may need to adjust the delay to make the system work properly.

To set the RS-232 Intercharacter Delay:

1. Scan the Enter/Exit Programming Mode bar code.
2. Scan the bar code below, [Set RS-232 Intercharacter Delay](#).
3. Scan the appropriate digits from the [Alpha-Numeric Keypad in Appendix C](#) that represent the desired delay. The selectable range is 0-100, which is the delay in 10-millisecond increments. Pad all single and double digit numbers with leading zeroes to yield a three-digit entry (000-100).

Examples:

001 = 10ms

005 = 50ms

040 = 400ms

100 = 1,000ms (1 second)

4. The scanner will automatically exit Programming Mode when the appropriate amount of digits have been scanned.



Set RS-232 Intercharacter Delay

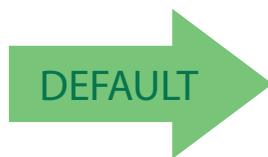

Default setting for this feature is:
00 - No Intercharacter Delay

RS-232 Software Flow Control

Enables/disables RS-232 Flow Control using XON/ XOFF characters.



This item will be ignored when the feature, RS-232 NAK Character, is enabled

NOTE

To set this feature:

1. Scan the Enter/Exit Programming Mode bar code.
2. Scan either the enable or disable bar code below. You'll need to cover any unused bar codes on this and the facing page to ensure that the scanner reads only the bar code you intend to scan.
3. Complete the programming sequence by scanning the Enter/Exit Programming Mode bar code.

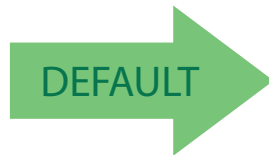

RS-232 Software Flow Control= Disable



RS-232 Software Flow Control= Enable



RS-232 Beep on ASCII BEL

Enables/disables ability of scanner to beep (sound a good read tone) on receiving an ASCII BEL (07 hex).

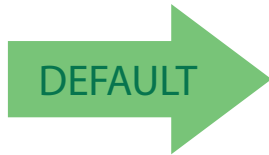

RS-232 Beep on ASCII BEL = Disable



RS-232 Beep on ASCII BEL = Enable

Beep on Not on File

Select for the host to beep (or not) when a not-on-file condition is detected by the host.



RS-232 Beep on Not on File = Muted



RS-232 Beep on Not on File = Low Volume



RS-232 Beep on Not on File = Medium Volume



RS-232 Beep on Not on File = High Volume

RS-232 ACK NAK Features

ACK NAK Enable

This enables/disables the ability of the scanner to support the RS-232 ACK/NAK protocol. When configured, the scanner and/or host sends an “ACK” when it receives data properly, and sends “NAK” when the data is in error. Selections for this option are:

- Disable ACK NAK
- Enable for Label Transmission — the scanner expects an ACK/NAK response from the host when a label is sent)
- Enable for Host Acknowledgement — Enabled for Host Commands (the scanner will respond with ACK/NAK when the host sends a command)
- Enable for Label & Host — Enabled for both Label Transmission & Host Command acknowledgement.

To select the option for RS-232 ACK NAK Enable:

1. Scan the Enter/Exit Programming Mode bar code.
2. Scan the desired option from bar codes below and on the following page. You’ll need to cover any unused bar codes on this and the facing page to ensure that the scanner reads only the bar code you intend to scan.
3. Complete the programming sequence by scanning the Enter/Exit Programming Mode bar code.

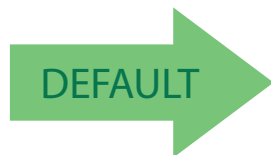

RS-232 ACK NAK = Disable



RS-232 ACK NAK = Enable for Label Transmission



RS-232 ACK NAK = Enable for Host Acknowledgement



RS-232 ACK NAK = Enable for Label & Host

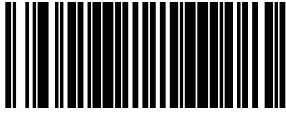

RS-232 ACK Character

This feature specifies which ASCII character will be used as an ACK character.



NOTE

DO NOT set this feature to use previously defined characters such as XON, XOFF or host commands as this will conflict with normal operation of these characters. 8-bit data is not recognized when the feature, RS-232 Number of Data Bits, is set to 7 data bits.

To specify the RS-232 ACK Character:

1. Scan the Enter/Exit Programming Mode bar code.
2. Scan the bar code, SET RS-232 ACK Character below. You'll need to cover any unused bar codes on this and the facing page to ensure the scanner reads only the bar code you intend to scan.
3. Scan the appropriate digits from the [Alpha-Numeric Keypad in Appendix C](#) that represent the hex designation for the desired character. A table containing the ASCII Character Set and their corresponding Hex Values is available in the inside back cover of this manual. ASCII parameters must be input by scanning a pair of hexadecimal digits for the desired character. For example, if ASCII "A" were the desired ACK character, you would scan the digits "4", then "1" (the ASCII corresponding hex value).
4. The scanner will automatically exit Programming Mode when the appropriate amount of digits/characters have been scanned.



Set RS-232 ACK Character

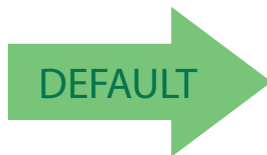

Default setting for this feature is:
06

RS-232 NAK Character

This feature specifies which ASCII character will be used as a NAK character.



NOTE

DO NOT set this feature to use previously defined characters such as XON, XOFF or host commands as this will conflict with normal operation of these characters. 8-bit data is not recognized when the feature, RS-232 Number of Data Bits, is set to 7 data bits.

To specify the RS-232 NAK Character:

1. Scan the Enter/Exit Programming Mode bar code.
2. Scan the bar code, SET RS-232 NAK Character below. You'll need to cover any unused bar codes on this and the facing page to ensure the scanner reads only the bar code you intend to scan.
3. Scan the appropriate digits from the [Alpha-Numeric Keypad in Appendix C](#) that represent the hex designation for the desired character. A table containing the ASCII Character Set and their corresponding Hex Values is available in the inside back cover of this manual. ASCII parameters must be input by scanning a pair of hexadecimal digits for the desired character. For example, if ASCII "A" were the desired NAK character, you would scan the digits "4", then "1" (the ASCII corresponding hex value).
4. The scanner will automatically exit Programming Mode when the appropriate amount of digits/characters have been scanned.

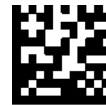

Set RS-232 NAK Character

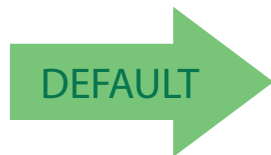

Default setting for this feature is:
15

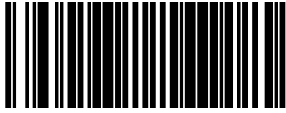

RS-232 Retry on ACK NAK Timeout

This option specifies the action scanner performs on expiration of the RS-232 ACK NAK Timeout Value.



RS-232 Retry on ACK NAK Timeout = Disable



RS-232 Retry on ACK NAK Timeout = Enable

RS-232 ACK NAK Timeout Value

This item specifies the time the scanner will wait for an ACK character from the host following a label transmission.

- 0 = Infinite timeout
- 1 - 75 = Timeout in 200-millisecond increments

To set the ACK NAK Timeout Value:

1. Scan the Enter/Exit Programming Mode bar code.
2. Scan the bar code below, [Set RS-232 ACK NAK Timeout Value](#). You'll need to cover any unused bar codes on this and the facing page to ensure that the scanner reads only the bar code you intend to scan.
3. Scan the appropriate digits from the [Alpha-Numeric Keypad in Appendix C](#) that represent the desired timeout. A setting of 0 specifies an infinite timeout. The remaining selectable range is 1-75, which is the timeout in 200-millisecond increments. Pad all single digit numbers with a leading zero to yield a two-digit entry (00-75).

Examples:

00 = Infinite timeout

01 = 200ms

05 = 1,000ms (1 second)

40 = 8,000ms (8 seconds)

75 = 15,000ms (15 seconds)

The scanner will automatically exit Programming Mode when the appropriate amount of digits have been scanned.



Set RS-232 ACK NAK Timeout Value

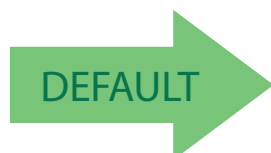

Default setting for this feature is:
01 - 200ms



RS-232 ACK NAK Retry Count

This feature sets the number of times for the scanner to retry a label transmission under a retry condition.

To set the RS-232 ACK NAK Retry Count:

1. Scan the Enter/Exit Programming Mode bar code.
2. Scan the bar code, [Set RS-232 ACK NAK Retry Count](#) below. You'll need to cover any unused bar codes on this and the facing page to ensure that the scanner reads only the bar code you intend to scan.
3. Scan the appropriate digits from the [Alpha-Numeric Keypad in Appendix C](#) that represent the desired number. The selectable range is 000-255 resets. Pad all single and double digit numbers with leading zeroes to yield a three-digit entry (000-255).



A setting of 255 specifies "retry forever."

NOTE

4. The scanner will automatically exit Programming Mode when the appropriate amount of digits have been scanned.



Set RS-232 ACK NAK Retry Count

Default setting for this feature is:
003 - Three retrys

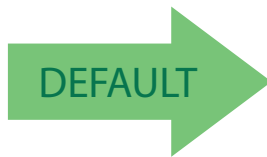

RS-232 ACK NAK Error Handling

This item specifies the method the scanner will use to handle errors detected while waiting to receive the ACK character from the host. Errors include unrecognized host commands and communication errors such as parity or framing errors.

- Ignore Errors (recommended setting)
- Assume ACK (risk of lost label data)
- Assume NAK (risk of duplicate label)

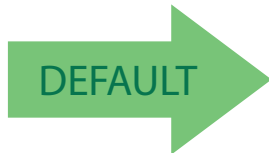

RS-232 ACK NAK Error Handling = Ignore Errors



RS-232 ACK NAK Error Handling = Assume ACK



RS-232 ACK NAK Error Handling = Assume NAK



RS-232 Indicate Transmission Failure

This feature enables / disables the ability of the scanner to sound a bad label beep indication when a transmission failure occurs.

To set this feature:

1. Scan the Enter/Exit Programming Mode bar code.
2. Scan the desired option from the bar codes below. You'll need to cover any unused bar codes on this and the facing page to ensure that the scanner reads only the bar code you intend to scan.
3. Complete the programming sequence by scanning the Enter/Exit Programming Mode bar code.



RS-232 Indicate Transmission Failure = Disable



RS-232 Indicate Transmission Failure = Enable



RS-232 Ignore Host Commands

When set to ignore host commands, the scanner will ignore all host commands except the minimum set necessary to keep the interface active and transmit labels. For normal operation of the interface, select Obey Host Commands.

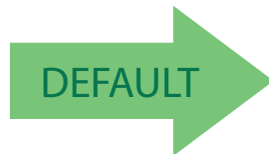

RS-232 Ignore Host Commands = Don't Ignore



RS-232 Ignore Host Commands = Ignore

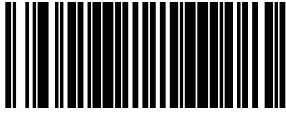

USB-OEM Interface Features

USB OEM Scanner Device Type

The OEM-USB protocol allows for the scanner to be identified as one of two different types of bar code scanners. Depending on what other scanners you may already have connected to a USB POS, you may need to change this setting to enable all scanners to communicate. Options are:

- Table Top Scanner
- Handheld Scanner

To set this feature:

1. Scan the Enter/Exit Programming Mode bar code.
2. Scan your selection from the bar codes below. You'll need to cover any unused bar codes on this and the facing page to ensure that the scanner reads only the bar code you intend to scan.
3. Complete the programming sequence by scanning the Enter/Exit Programming Mode bar code.

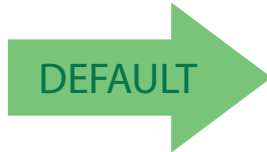

USB OEM Scanner Device Type = Table Top Scanner



USB OEM Scanner Device Type = Handheld Scanner

USB OEM Additional Interface Options

To set this feature:

1. Scan the Enter/Exit Programming Mode bar code.
2. Scan your selection from the bar codes below. You'll need to cover any unused bar codes on this and the facing page to ensure that the scanner reads only the bar code you intend to scan.

Complete the programming sequence by scanning the Enter/Exit Programming Mode bar code



USB OEM Interfaces Option2 =
Enable scanner at first enumeration after BusReset

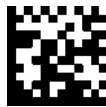

USB OEM Interfaces Option2 =
Disable scanner at first enumeration after BusReset





USB Keyboard Features

As a keyboard interface, the scanner supports most popular PC terminals.

Keyboard Layout

The Keyboard Layout option supports many countries. For details about Keyboard Layout, please refer to your operating system manual.

USB Keyboard Country Mode

This feature specifies the country/language that will be supported by the keyboard.

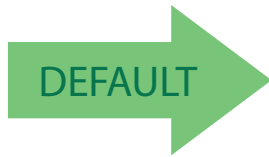

USB Keyboard Country Mode = USA

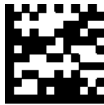

USB Keyboard Country Mode = Belgium



USB Keyboard Country Mode = Britain



USB Keyboard Country Mode = Denmark



USB Keyboard Country Mode = France



USB Keyboard Country Mode = Germany

USB Keyboard Country Mode (continued)



USB Keyboard Country Mode = Italy

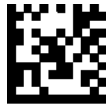

USB Keyboard Country Mode =
Norway



USB Keyboard Country Mode =
Portugal



USB Keyboard Country Mode = Spain



USB Keyboard Country Mode =
Sweden



USB Keyboard Country Mode =
Switzerland



USB Keyboard Country Mode =
Japanese 106-key



USB Keyboard Country Mode (continued)



USB Keyboard Country Mode = Hungary



USB Keyboard Country Mode =
Czech Republic



USB Keyboard Country Mode = Slovakia



USB Keyboard Country Mode =
Romania



USB Keyboard Country Mode =
Croatia



USB Keyboard Country Mode = Poland



USB Keyboard Country Mode =
French Canadian



USB Keyboard Country Mode = Turkish

USB Keyboard Caps Lock State

This feature specifies the format in which the scanner sends character data. Selections are:

Caps Lock OFF — Send character data in normal format

Caps Lock ON — Send character data in reverse case

Shift Lock Mode — This setting results in a Caps Lock OFF functionality.

Caps Lock Compensation Mode — This only applies to USB Keyboard. For other interfaces, this setting results in a Caps Lock OFF functionality.

To set this feature:

1. Scan the Enter/Exit Programming Mode bar code.
2. Scan the desired selection from the bar codes below. You'll need to cover any unused bar codes on this and the facing page to ensure that the scanner reads only the bar code you intend to scan.
3. Complete the programming sequence by scanning the Enter/Exit Programming Mode bar code.

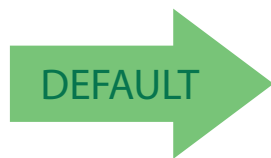

USB Keyboard Caps Lock State =
Caps Lock OFF



USB Keyboard Caps Lock State =
Caps Lock ON



USB Keyboard Caps Lock State =
Shift Lock Mode



USB Keyboard Caps Lock State =
Caps Lock Compensation

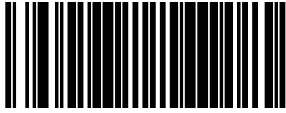

No Keyboard Support

Enables the scanner to perform host communications normally performed by an attached keyboard.

To set this feature:

1. Scan the Enter/Exit Programming Mode bar code.
2. Scan either the enable or disable bar code below. You'll need to cover any unused bar codes on this and the facing page to ensure that the scanner reads only the bar code you intend to scan.
3. Complete the programming sequence by scanning the Enter/Exit Programming Mode bar code.

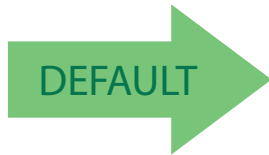

No Keyboard Support = Disable

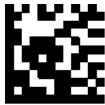

No Keyboard Support = Enable

USB Keyboard Send Control Characters

This feature specifies how the scanner transmits ASCII control characters to the host.



NOTE

Affects suffix and prefix characters. When disabled, only ASCII characters between 20H and 127H inclusive (space... delete) plus special characters 0DH (carriage return), 08H (backspace), 27H (ESC), 09H (right tab) and 0BH (left tab) are transmitted.

Choices are:

Disable — No control characters are sent to the host.

Enable transmission of control characters to host — Control characters are sent to the host.

Send characters between 00H and 1FH — Send characters between 00H and 1FH according to special function–key mapping table (This is used to send keys that are not in normal ASCII set; a unique set is provided for each available scancode set).

To set this feature:

1. Scan the Enter/Exit Programming Mode bar code.
2. Scan the bar code for the desired setting below. You'll need to cover any unused bar codes on this and the facing page to ensure that the scanner reads only the bar code you intend to scan.
3. Complete the programming sequence by scanning the Enter/Exit Programming Mode bar code.

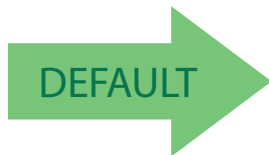

Keyboard Send Control Characters = Disable



Keyboard Send Control Characters =
Enable transmission of control characters to host



USB Keyboard No Keyboard Support =
Send characters between 00H and 1FH

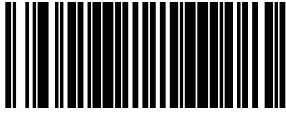

Quiet Interval

This setting specifies the amount of time to monitor for keyboard activity before breaking the keyboard connection.

To set this feature:

1. Scan the Enter/Exit Programming Mode bar code.
2. Scan the bar code below, [Set Quiet Interval](#). You'll need to cover any unused bar codes on this and the facing page to ensure that the scanner reads only the bar code you intend to scan.
3. Scan the appropriate digits from the [Alpha-Numeric Keypad in Appendix C](#) that represent the desired time interval. The selectable range is 001–100, which is the interval in 10–millisecond increments. Pad all single and double digit numbers with leading zeroes to yield a three–digit entry (001–100).

Examples:

001 = 10ms

005 = 50ms

040 = 400ms

100 = 1,000ms (1 second)

4. The scanner will automatically exit Programming Mode when the appropriate amount of digits have been scanned.



Set Quiet Interval

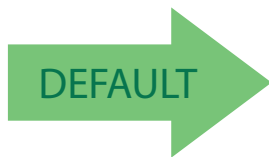

Default setting for this feature is:
00A - 100ms

USB Keyboard Intercharacter Delay

Specifies a time delay between characters.

To set this feature:

1. Scan the Set USB Keyboard Intercharacter Delay bar code below.
2. Scan the appropriate characters/digits from the [Alpha-Numeric Keypad in Appendix C](#) that represent the desired delay. The selectable range for this option is any decimal value from 00 (no delay) to 99 in 10 ms increments. A table containing the ASCII Character Set and their corresponding decimal values is available in the inside back cover of this manual. ASCII parameters must be input by scanning decimal digits for each character. Pad all single digit numbers with leading zero to yield a two-digit entry (00–99). Thus, to set an intercharacter delay of 70ms, bar codes containing the digits '0' and '7' must be scanned.
3. Complete the programming sequence by scanning the Enter/Exit Programming Mode bar code.



Set USB Keyboard Intercharacter Delay

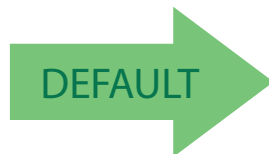

Default setting for this feature is: 01 (10ms)

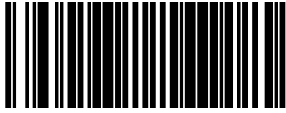

USB Keyboard Additional Interface Options

See "Keyboard Function Key Mappings" on page 299 for more information.

To set this feature:

1. Scan the Enter/Exit Programming Mode bar code.
2. Scan your selection from the bar codes below. You'll need to cover any unused bar codes on this and the facing page to ensure that the scanner reads only the bar code you intend to scan.
3. Complete the programming sequence by scanning the Enter/Exit Programming Mode bar code.



USB Keyboard Interface Option 1 =
Use Rev C function table



USB Keyboard Interfaces Option 2 =
Use Rev D function table





Data Editing

DATA EDITING OVERVIEW starting on page 88
GLOBAL PREFIX/SUFFIX starting on page 89 <ul style="list-style-type: none">•Global Prefix on page 89•Global Suffix on page 90
AIM ID starting on page 91
LABEL ID starting on page 92 <ul style="list-style-type: none">•Label ID Control on page 92•Setting Label ID on page 93•1D Symbologies on page 94•2D Symbologies on page 99
CASE CONVERSION starting on page 101
CHARACTER CONVERSION starting on page 102



Data Editing Overview

When a bar code is scanned, additional information can be sent to the host computer along with the bar code data. This combination of bar code data and supplementary user-defined data is called a “message string.” The features in this chapter can be used to build specific user-defined data into a message string.

There are several types of selectable data characters that can be sent before and after scanned data. You can specify if they should be sent with all symbologies, or only with specific symbologies. Figure 7 shows the available elements you can add to a message string:

Figure 7. Breakdown of a Message String

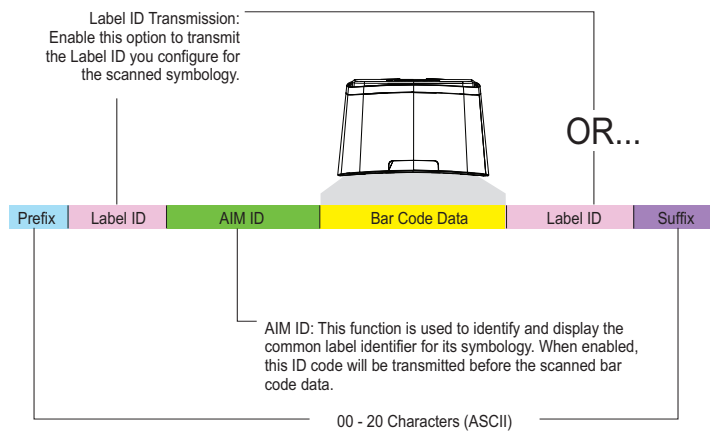

Please Keep In Mind...

- Modifying a message string is not a mandatory requirement. Data editing is a sophisticated feature allowing highly customizable output for advanced users. Factory default settings for data editing is typically set to NONE.
- A prefix or suffix may be applied (reference the [1D Symbologies](#) chapter for these settings) or across all symbologies (set via the Global features in this chapter).
- You can add any character from the [ASCII Character Set](#) (from 00–FF) on the inside back cover of this manual as a prefix, suffix or Label ID.
- Enter prefixes and suffixes in the order in which you want them to appear on the output.

Global Prefix/Suffix

Global Prefix

This feature applies to RS-232 interfaces (Standard, Wincor-Nixdorf). It specifies the prefix that is added to beginning of label transmission.

To specify the Global Prefix Character(s):

1. Scan the Enter/Exit Programming Mode bar code.
2. Scan the bar code Set Global Prefix below. Cover any unused bar codes to ensure the scanner reads only the bar code you intend to scan.
3. Scan the appropriate characters/digits from the [Alpha-Numeric Keypad on page 283](#) that represent the hex designation for the desired character(s). The ASCII Character Set and their corresponding Hex Values are available in the inside back cover of this manual. ASCII parameters must be input by scanning a pair of hexadecimal digits for each character. Thus, to set a two-character value of AB, bar codes containing the digits '4', '1', '4', and '2' must be scanned. The selectable range for this option is any hex value from 00 to FF. Up to 20 hex pairs can be designated.



To specify "No Global Prefix," scan 00.

NOTE

4. If designating the full 20 hex pairs, the scanner will exit Programming Mode when the appropriate amount of digits have been scanned. If designating less than 20 hex pairs, you can end the programming sequence early by scanning the Terminate Sequence bar code.
5. Complete the programming sequence by scanning the Enter/Exit Programming Mode bar code.



Set Global Prefix



Terminate Sequence



Default setting for this feature is:
00 - No Global Prefix



Global Suffix

This feature applies to RS-232 interfaces (Standard, Wincor-Nixdorf). It specifies the suffix that is added to end of a label transmission. Three standard options are available below. Contact your dealer for other alternate settings for this feature.

- No Global Suffix
- CR — Carriage Return
- CR LF — Carriage Return, Line Feed

To set the Global Suffix:

1. Scan the Enter/Exit Programming Mode bar code.
2. Scan your selection from the bar codes below.
3. Complete the programming sequence by scanning the Enter/Exit Programming Mode bar code.



Global Suffix = No Global Suffix



Global Suffix = CR



Global Suffix = CR LF

AIM ID

AIM (Automatic Identification Manufacturers) label identifiers are assigned from a globally standardized list — as opposed to custom label ID characters you select yourself — and can be included with scanned bar code data. AIM label identifiers consist of three characters as follows:

- A close brace character (ASCII ‘}’), followed by...
- A code character (see the table below), followed by...
- A modifier character (the modifier character is symbol dependent)

SYMBOLGY	CHAR	SYMBOLGY	CHAR
UPC/EAN	E	Code 128/EAN 128	C
Code 39	A	GS1 Omnidirectional, GS1 Expanded	e
Codabar	F	Standard 2 of 5	S
Interleaved 2 of 5	I	ISBN	X ^a
Code 93	G		

a. ISBN (X with a 0 modifier character)

Figure 8. AIM ID

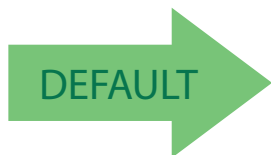
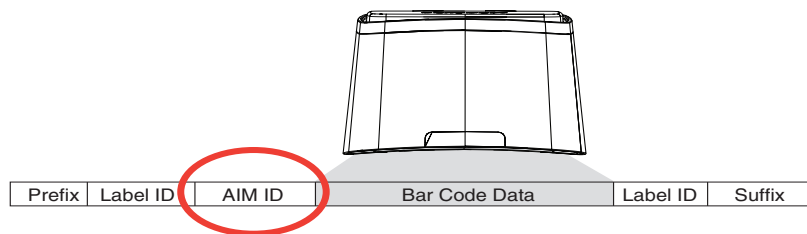

Global AIM ID = Disable



Global AIM ID = Enable



Label ID

Label ID Control

This feature specifies whether or not Label IDs are transmitted to the host and if so, whether to attach them as a prefix or suffix.

Choices are:

- Disable
- Enable as a Prefix
- Enable as a Suffix

To select the option for Label ID Control:

1. Scan the Enter/Exit Programming Mode bar code.
2. Scan the desired option from the bar codes below. You'll need to cover any unused bar codes on this and the facing page to ensure that the scanner reads only the bar code you intend to scan.
3. Complete the programming sequence by scanning the Enter/Exit Programming Mode bar code.



Label ID Control = Disable



Label ID Control = Enable as a Prefix



Label ID Control = Enable as a Suffix

Setting Label ID

This feature allows the setting of custom Label ID character(s) for each available symbology type if other than the default Label ID is desired.





To set this feature:

1. Scan the Enter/Exit Programming Mode bar code.
2. Scan the bar code for the desired symbology below. You'll need to cover any unused bar codes on this and the facing page to ensure the scanner reads only the bar code you intend to scan.
3. Scan the appropriate digits from the [Alpha-Numeric Keypad on page 283](#) that represent the desired Label ID characters; entered as two hex pairs. A table containing the ASCII Character Set and their corresponding Hex Values is available in the inside back cover of this manual. ASCII parameters must be input by scanning a pair of hexadecimal digits for each character. Thus, to set a two-character value of AB, bar codes containing the digits '4', '1', '4', and '2' must be scanned. The selectable range for this option is any hex value from 00 to FF.

Complete the programming sequence by scanning the Enter/Exit Programming Mode bar code.



1D Symbolologies

<p>Default Label ID for this symbology is: 41 = A</p>	 <p>Set UPC-A Label ID</p>
 <p>Set UPC-A 2-Digit Supplemental Label ID</p>	<p>Default Label ID for this symbology is: 41 = A</p>
<p>Default Label ID for this symbology is: 41 = A</p>	 <p>Set UPC-A 5-Digit Supplemental Label ID</p>
 <p>Set UPC-E Label ID</p>	<p>Default Label ID for this symbology is: 45 = E</p>

Setting Label ID (continued)





Default Label ID for this symbology is: 45 = E	 Set UPC-E 2-Digit Supplemental Label ID
 Set UPC-E 5-Digit Supplemental Label ID	Default Label ID for this symbology is: 45 = E
Default Label ID for this symbology is: 46 = F	 Set EAN-13 Label ID
 Set EAN-13 2-Digit Supplemental Label ID	Default Label ID for this symbology is: 46 = F
Default Label ID for this symbology is: 46 = F	 Set EAN-13 5-Digit Supplemental Label ID
 Set EAN-8 Label ID	Default Label ID for this symbology is: 4646 = FF
Default Label ID for this symbology is: 4646 = FF	 Set EAN-8 2-Digit Supplemental Label ID



Setting Label ID (continued)

 Set EAN-8 5-Digit Supplemental Label ID	Default Label ID for this symbology is: 4646 = FF
Default Label ID for this symbology is: 47 = G	 Set GTIN Label ID
 Set GTIN 2-Digit Supplemental Label ID	Default Label ID for this symbology is: 4732 = G2
Default Label ID for this symbology is: 4735 = G5	 Set GTIN 5-Digit Supplemental Label ID
 Set GTIN Code 128 Supplemental Label ID	Default Label ID for this symbology is: 4738 = G8
Default Label ID for this symbology is: 5234 = R4	 Set DataBar Omnidirectional Label ID
 Set DataBar Omnidirectional Composite Label ID	Default Label ID for this symbology is: 5234 = R4
Default Label ID for this symbology is: 5258 = RX	 Set DataBar Limited Label ID

Setting Label ID (continued)

Default Label ID for this symbology is: 5258 = RX	 DataBar Expanded Label ID
 DataBar Expanded Composite Label ID	Default Label ID for this symbology is: 5258 = RX
Default Label ID for this symbology is: 5258 = RX	 Set DataBar Limited Composite Label ID
 Code 39 Label ID	Default Label ID for this symbology is: 2A = *
Default Label ID for this symbology is: 41 = A	 Code 32 Label ID
 Code 128 Label ID	Default Label ID for this symbology is: 23 = #
Default Label ID for this symbology is: 50 = P	 EAN 128 Label ID



Setting Label ID (continued)

<p>Default Label ID for this symbology is: 69 = i</p>	 <p>12 of 5 Label ID</p>
 <p>Codabar Label ID</p>	<p>Default Label ID for this symbology is: 25 = %</p>
<p>Default Label ID for this symbology is: 26 = &</p>	 <p>Code 93 Label ID</p>
 <p>MSI Label ID</p>	<p>Default Label ID for this symbology is: 40 = @</p>
<p>Default Label ID for this symbology is: 73 = s</p>	 <p>Standard 2 of 5 Label ID</p>
 <p>ISBN Label ID</p>	<p>Default Label ID for this symbology is: 49 = l</p>

2D Symbologies

Default Label ID for this symbology is: 446D = Dm	 Data Matrix Label ID
 PDF 417 Label ID	Default Label ID for this symbology is: 50 = P
Default Label ID for this symbology is: 6D50 = mP	 Micro PDF 417 Label ID
 QR Code Label ID	Default Label ID for this symbology is: 5152 = QR
Default Label ID for this symbology is: 2451 = \$Q	 Micro QR Code Label ID
 Aztec Label ID	Default Label ID for this symbology is: 417A = Az
Default Label ID for this symbology is: 4467 = Dg	 GS1 Datamatrix label ID
 GS1 QR Code label ID	Default Label ID for this symbology is: 5147 = QG



Global Mid-Label ID

This feature specifies a global mid-label ID that is added between two bar codes for transmission.

To set this feature:

1. Scan the Enter/Exit Programming Mode bar code.
2. Scan the [Set Global Mid-Label ID on page 100](#) bar code below. You'll need to cover any unused bar codes on this and the facing page to ensure the scanner reads only the bar code you intend to scan.
3. Scan the appropriate digits from the [Keypad on page 461](#) in [Appendix C](#) that represent the desired mid-label ID characters; entered as two hex pairs. A table containing the ASCII Character Set and their corresponding Hex Values is available in the inside back cover of this manual. ASCII parameters must be input by scanning a pair of hexadecimal digits for each character. Thus, to set a two-character value of AB, bar codes containing the digits '4', '1', '4', and '2' must be scanned. The selectable range for this option is any hex value from 00 to FF.

Complete the programming sequence by scanning the Enter/Exit Programming Mode bar code.



Set Global Mid-Label ID

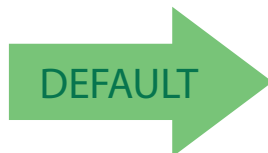

Default Label ID for this symbology is:
00 = No Global Mid-label ID

Case Conversion

This option can change the case of all alphabetic characters in scanned bar code data to upper or lower case.



NOTE

Case conversion affects ONLY scanned bar code data, and does not affect Label ID, Prefix, Suffix, or other appended data.

To set this feature:

1. Scan the Enter/Exit Programming Mode bar code.
2. Scan bar code for the desired option below. You'll need to cover any unused bar codes on this and the facing page to ensure that the scanner reads only the bar code you intend to scan.
3. Complete the programming sequence by scanning the Enter/Exit Programming Mode bar code.

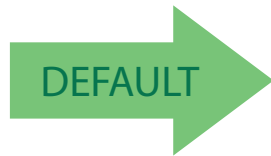

Case Conversion = No Case Conversion



Case Conversion = Upper Case



Case Conversion = Lower Case



Character Conversion

Character conversion is an eight byte configuration item. The eight bytes are 4 character pairs represented in hexadecimal ASCII values. The first character in the pair is the character that will be converted. The second character in the pair is the character to convert to. If the character to convert in a pair is FF, then no conversion is done.

For example, if you have the character conversion configuration item set to the following:

41423132FFFFFFF

The first pair is 4142 or AB (41 hex is an ASCII capital A, 42 hex is an ASCII capital B) and the second pair is 3132 or 12 (31 hex is an ASCII 1, 32 is an ASCII 2). The other two pairs are FFFF and FFFF.

With the label, AG15TA81, it would look as follows after the character conversion: BG25TB82.

The A characters were converted to the B character and the 1 characters were converted to the numeral 2 character. Nothing is done with the last two character pairs, since they are all FF.

To set Character Conversion:

1. Scan the Enter/Exit Programming Mode bar code.
2. Scan the Character Conversion bar code.
3. Determine the desired string. Up to sixteen positions can be determined as in the above example. Next, turn to the ASCII Chart on the inside back cover of this manual and find the equivalent hex digits needed to fulfill the string.



The positions not used must be filled with the character 'F'.

NOTE

4. Turn to the [Alpha-Numeric Keypad on page 283](#) and scan the bar codes representing the hex characters determined in the previous step. When the last character is scanned, the scanner will sound a triple beep.
5. Complete the programming sequence by scanning the Enter/Exit Programming Mode bar code.



Set Character Conversion

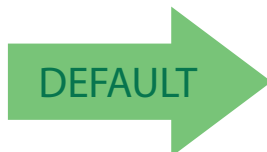

Default setting for this feature is:
FFFFFFFFFFFFFFFF (No Character Conversion)



1D Symbology Programming

1D Symbologies



NOTE

If the scanner's interface type must be changed, always be sure that interface configuration is the **FIRST** item scanned during a programming session. (Selecting an interface type resets **ALL** other configuration items — including symbology programming — to the factory default for that interface type.)

The following pages contain configuration information concerning the various bar code types (symbologies) the scanner supports.

COUPON CONTROL starting on page 104
UPC-A starting on page 106
UPC-E starting on page 111
EAN-13 starting on page 117
EAN-8 starting on page 122
OTHER UPC/EAN OPTIONS starting on page 134
GTIN starting on page 155
GS1 DATABAR starting on page 156
DATABAR OMNIDIRECTIONAL starting on page 156
DATABAR LIMITED starting on page 162
DATABAR EXPANDED starting on page 166
CODE 39 starting on page 174
CODE 32 ITALIAN PHARMACODE starting on page 186
CODE 128 starting on page 189
EAN-128 starting on page 198
INTERLEAVED 2 OF 5 (I 2 OF 5) starting on page 199
CODABAR starting on page 208
CODE 93 starting on page 221
MSI starting on page 228
STANDARD 2 OF 5 starting on page 238

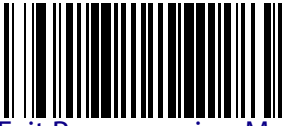

Coupon Control

Coupon Control Enable

This feature is used to control the method of processing coupon labels. For the purposes of this feature, coupon labels are defined as:

1. UPC-A labels that start with a '5'
2. GS1 DataBar Expanded labels that start with '8110'

The options for this setting are:

- Disable — Coupon Control is turned off.
- Enable UPC-A Coupons — UPC-A coupon labels will decode but GS1 DataBar Expanded coupon labels will not. GS1 DataBar Expanded labels that are not coupon labels will decode and all UPC-A labels will decode.
- Enable GS1 DataBar Expanded Coupons — GS1 DataBar Expanded coupon labels will decode but UPC-A coupon labels will not. UPC-A labels that are not coupon labels will decode and all GS1 DataBar Expanded labels will decode.

To set this feature:

1. Scan the Enter/Exit Programming Mode bar code.
2. Scan your choice from the Coupon Control selections below. You'll need to cover any unused bar codes on this and the facing page to ensure that the scanner reads only the bar code you intend to scan.
3. Complete the programming sequence by scanning the Enter/Exit Programming Mode bar code.



Coupon Control = Disable



Coupon Control = Enable UPC-A Coupons



Coupon Control = Enable GS1 DataBar Expanded Coupons

Coupon Label Priority Timer

This feature sets the duration of the UPCA / DataBar coupon label priority timer.
 To set this feature:

1. Scan the Enter/Exit Programming Mode bar code.
2. Scan your selection from the bar codes below. You'll need to cover any unused bar codes on this and the facing page to ensure that the scanner reads only the bar code you intend to scan.
3. Complete the programming sequence by scanning the Enter/Exit Programming Mode bar code.



Coupon Label Priority Timer = 0.1 Seconds



Coupon Label Priority Timer = 0.2 Seconds



Coupon Label Priority Timer = 0.3 Seconds



Coupon Label Priority Timer = 0.4 Seconds



Coupon Label Priority Timer = 0.5 Second



Coupon Label Priority Timer = 1 Second

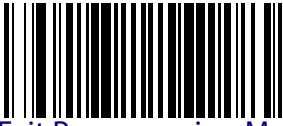

UPC-A

UPC-A Enable

Enables/disables the ability of the scanner to decode UPC-A labels.

To set this feature:

1. Scan the Enter/Exit Programming Mode bar code.
2. Scan either the enable or disable bar code below. You'll need to cover any unused bar codes on this and the facing page to ensure that the scanner reads only the bar code you intend to scan.
3. Complete the programming sequence by scanning the Enter/Exit Programming Mode bar code.



UPC-A = Disable



UPC-A = Enable



UPC-A Number System Character Transmission

Enables/disables transmission of a UPC-A number system character.



This item is ignored when the advanced feature, Full Label Edit, is enabled.

NOTE

To set this feature:

1. Scan the Enter/Exit Programming Mode bar code.
2. Scan either the enable or disable bar code below. You'll need to cover any unused bar codes on this and the facing page to ensure that the scanner reads only the bar code you intend to scan.
3. Complete the programming sequence by scanning the Enter/Exit Programming Mode bar code.



UPC-A Number System Character Transmission =
Disable



UPC-A Number System Character Transmission = Enable



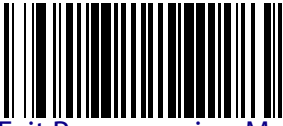

UPC-A Check Character Transmission

Enables/disables transmission of a UPC-A check character.



This item is ignored when the advanced feature, Full Label Edit, is enabled.

NOTE

To set this feature:

1. Scan the Enter/Exit Programming Mode bar code.
2. Scan either the enable or disable bar code below. You'll need to cover any unused bar codes on this and the facing page to ensure that the scanner reads only the bar code you intend to scan.
3. Complete the programming sequence by scanning the Enter/Exit Programming Mode bar code.



UPC-A Check Character Transmission = Disable



UPC-A Check Character Transmission = Enable



UPC-A Minimum Read

This feature specifies the minimum number of consecutive UPC-A decodes before is accepted as good read.

To set this feature:

1. Scan the ENTER/EXIT Programming Mode bar code.
2. Scan your selection from the bar codes below. You'll need to cover any unused bar codes on this and the facing page to ensure that the scanner reads only the bar code you intend to scan.
3. Complete the programming sequence by scanning the ENTER/EXIT Programming Mode bar code.

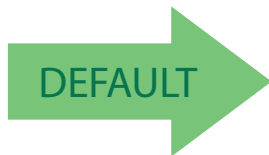

UPC-A Minimum Read = 1



UPC-A Minimum Read = 2



UPC-A Minimum Read = 3



UPC-A Minimum Read = 4

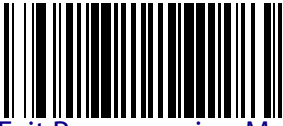

Expand UPC-A to EAN-13

Enables/disables expansion of UPC-A labels to EAN/JAN-13.

To set this feature:

1. Scan the Enter/Exit Programming Mode bar code.
2. Scan either the enable or disable bar code below. You'll need to cover any unused bar codes on this and the facing page to ensure that the scanner reads only the bar code you intend to scan.
3. Complete the programming sequence by scanning the Enter/Exit Programming Mode bar code.

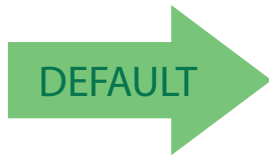

Expand UPC-A to EAN-13 = Disable



Expand UPC-A to EAN-13 = Enable

UPC-E

UPC-E Enable

Enables/disables the ability of the scanner to decode UPC-E labels.

To set this feature:

1. Scan the Enter/Exit Programming Mode bar code.
2. Scan either the enable or disable bar code below. You'll need to cover any unused bar codes on this and the facing page to ensure that the scanner reads only the bar code you intend to scan.
3. Complete the programming sequence by scanning the Enter/Exit Programming Mode bar code.



UPC-E = Disable



UPC-E = Enable



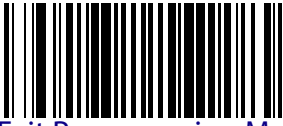

UPC-E Number System Character Transmission

Enables/disables transmission of a UPC-E number system character.



This item is ignored when the advanced feature, Full Label Edit, is enabled.

NOTE

To set this feature:

1. Scan the Enter/Exit Programming Mode bar code.
2. Scan either the enable or disable bar code below. You'll need to cover any unused bar codes on this and the facing page to ensure that the scanner reads only the bar code you intend to scan.
3. Complete the programming sequence by scanning the Enter/Exit Programming Mode bar code.



UPC-E Number System Character Transmission = Disable



UPC-E Number System Character Transmission = Enable



UPC-E Check Character Transmission

Enables/disables transmission of a UPC-E check character.



This item is ignored when the advanced feature, Full Label Edit, is enabled.

NOTE

To set this feature:

1. Scan the Enter/Exit Programming Mode bar code.
2. Scan either the enable or disable bar code below. You'll need to cover any unused bar codes on this and the facing page to ensure that the scanner reads only the bar code you intend to scan.
3. Complete the programming sequence by scanning the Enter/Exit Programming Mode bar code.



UPC-E Check Character Transmission = Disable



UPC-E Check Character Transmission = Enable



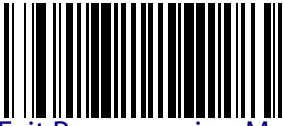

Expand UPC-E to UPC-A

Enables/disables expansion of UPC-E labels to UPC-A.

To set this feature:

1. Scan the Enter/Exit Programming Mode bar code.
2. Scan either the enable or disable bar code below. You'll need to cover any unused bar codes on this and the facing page to ensure that the scanner reads only the bar code you intend to scan.
3. Complete the programming sequence by scanning the Enter/Exit Programming Mode bar code.

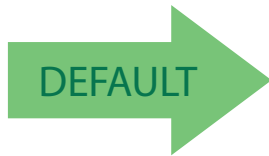

Expand UPC-E to UPC-A = Disable



Expand UPC-E to UPC-A = Enable

Expand UPC-E to EAN-13

Enables/disables expansion of UPC-E labels to EAN/JAN-13.

To set this feature:

1. Scan the Enter/Exit Programming Mode bar code.
2. Scan either the enable or disable bar code below. You'll need to cover any unused bar codes on this and the facing page to ensure that the scanner reads only the bar code you intend to scan.
3. Complete the programming sequence by scanning the Enter/Exit Programming Mode bar code.

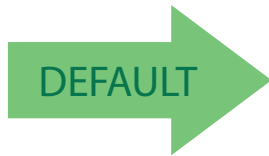

Expand UPC-E to EAN-13 = Disable



Expand UPC-E to EAN-13 = Enable

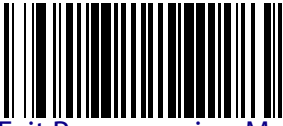

UPC-E Minimum Read

This feature specifies the minimum number of consecutive UPC-E decodes before is accepted as good read.

To set this feature:

1. Scan the ENTER/EXIT Programming Mode bar code.
2. Scan your selection from the bar codes below. You'll need to cover any unused bar codes on this and the facing page to ensure that the scanner reads only the bar code you intend to scan.
3. Complete the programming sequence by scanning the ENTER/EXIT Programming Mode bar code.

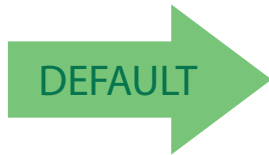

UPC-E Minimum Read = 1



UPC-E Minimum Read = 2



UPC-E Minimum Read = 3



UPC-E Minimum Read = 4

EAN-13

EAN-13 Enable

Enables/disables the ability of the scanner to decode EAN/JAN-13 labels.
To set this feature:

1. Scan the Enter/Exit Programming Mode bar code.
2. Scan either the enable or disable bar code below. You'll need to cover any unused bar codes on this and the facing page to ensure that the scanner reads only the bar code you intend to scan.
3. Complete the programming sequence by scanning the Enter/Exit Programming Mode bar code.



EAN-13 = Disable



EAN-13 = Enable



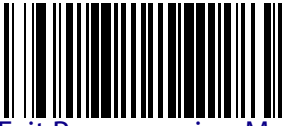

EAN-13 First Character Transmission

Enables/disables transmission of EAN/JAN-13 first character.



This item is ignored when the advanced feature, Full Label Edit, is enabled.

NOTE

To set this feature:

1. Scan the Enter/Exit Programming Mode bar code.
2. Scan either the enable or disable bar code below. You'll need to cover any unused bar codes on this and the facing page to ensure that the scanner reads only the bar code you intend to scan.
3. Complete the programming sequence by scanning the Enter/Exit Programming Mode bar code.



EAN-13 First Character Transmission = Disable



EAN-13 First Character Transmission = Enable



EAN-13 Check Character Transmission

Enables/disables transmission of an EAN/JAN-13 check character.



This item is ignored when the advanced feature, Full Label Edit, is enabled.

NOTE

To set this feature:

1. Scan the Enter/Exit Programming Mode bar code.
2. Scan either the enable or disable bar code below. You'll need to cover any unused bar codes on this and the facing page to ensure that the scanner reads only the bar code you intend to scan.
3. Complete the programming sequence by scanning the Enter/Exit Programming Mode bar code.



EAN-13 Check Character Transmission = Disable



EAN-13 Check Character Transmission = Enable



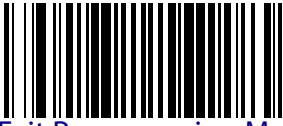

EAN-13 ISBN Conversion Enable

Enables/disables conversion of EAN/JAN-13 labels starting with 978 to Bookland ISBN labels.

To set this feature:

1. Scan the Enter/Exit Programming Mode bar code.
2. Scan either the enable or disable bar code below. You'll need to cover any unused bar codes on this and the facing page to ensure that the scanner reads only the bar code you intend to scan.
3. Complete the programming sequence by scanning the Enter/Exit Programming Mode bar code.

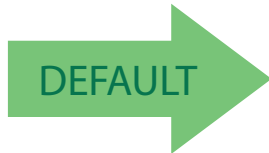

EAN-13 ISBN Conversion = Disable



EAN-13 ISBN Conversion = Enable

EAN-13 Minimum Read

This feature specifies the minimum number of consecutive EAN-13 decodes before is accepted as good read.

To set this feature:

1. Scan the ENTER/EXIT Programming Mode bar code.
2. Scan your selection from the bar codes below. You'll need to cover any unused bar codes on this and the facing page to ensure that the scanner reads only the bar code you intend to scan.
3. Complete the programming sequence by scanning the ENTER/EXIT Programming Mode bar code.

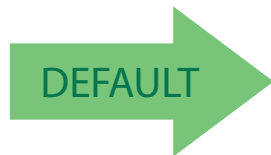

EAN-13 Minimum Read = 1



EAN-13 Minimum Read = 2



EAN-13 Minimum Read = 3



EAN-13 Minimum Read = 4

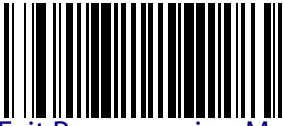

EAN-8

EAN-8 Enable

Enables/disables the ability of the scanner to decode EAN/JAN-8 labels.
To set this feature:

1. Scan the Enter/Exit Programming Mode bar code.
2. Scan either the enable or disable bar code below. You'll need to cover any unused bar codes on this and the facing page to ensure that the scanner reads only the bar code you intend to scan.
3. Complete the programming sequence by scanning the Enter/Exit Programming Mode bar code.



EAN-8 = Disable



EAN-8 = Enable



EAN-8 Check Character Transmission

Enables/disables transmission of an EAN/JAN-8 check character.



This item is ignored when the advanced feature, Full Label Edit, is enabled.

NOTE

To set this feature:

1. Scan the Enter/Exit Programming Mode bar code.
2. Scan either the enable or disable bar code below. You'll need to cover any unused bar codes on this and the facing page to ensure that the scanner reads only the bar code you intend to scan.
3. Complete the programming sequence by scanning the Enter/Exit Programming Mode bar code.



EAN-8 Check Character Transmission = Disable



EAN-8 Check Character Transmission = Enable



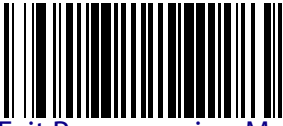

Expand EAN-8 to EAN-13

Enables/disables expansion of EAN/JAN-8 labels to EAN/JAN-13.

To set this feature:

1. Scan the Enter/Exit Programming Mode bar code.
2. Scan either the enable or disable bar code below. You'll need to cover any unused bar codes on this and the facing page to ensure that the scanner reads only the bar code you intend to scan.
3. Complete the programming sequence by scanning the Enter/Exit Programming Mode bar code.

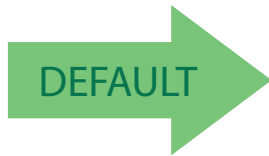

Expand EAN-8 to EAN-13 = Disable



Expand EAN-8 to EAN-13 = Enable

EAN-8 Minimum Read

This feature specifies the minimum number of consecutive EAN-8 decodes before is accepted as good read.

To set this feature:

1. Scan the ENTER/EXIT Programming Mode bar code.
2. Scan your selection from the bar codes below. You'll need to cover any unused bar codes on this and the facing page to ensure that the scanner reads only the bar code you intend to scan.
3. Complete the programming sequence by scanning the ENTER/EXIT Programming Mode bar code.

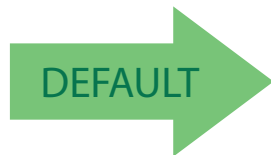

EAN-8 Minimum Read = 1



EAN-8 Minimum Read = 2



EAN-8 Minimum Read = 3



EAN-8 Minimum Read = 4

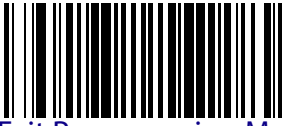

EAN-8 Guard Insertion

This setting enables the insertion of either a missing leading or trailing guard to a scanned bar code.

To set this feature:

1. Scan the Enter/Exit Programming Mode bar code.
2. Scan either the enable or disable bar code below. You'll need to cover any unused bar codes on this and the facing page to ensure that the scanner reads only the bar code you intend to scan.
3. Complete the programming sequence by scanning the Enter/Exit Programming Mode bar code.

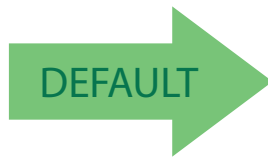

EAN-8 Guard Insertion = Disable

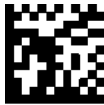

EAN-8 Guard Insertion = Enable

EAN-8 Guard Substitution

This setting enables the scanner to substitute a guard pattern for even-parity 6 for EAN8/JAN8 labels.

To set this feature:

1. Scan the Enter/Exit Programming Mode bar code.
2. Scan either the enable or disable bar code below. You'll need to cover any unused bar codes on this and the facing page to ensure that the scanner reads only the bar code you intend to scan.
3. Complete the programming sequence by scanning the Enter/Exit Programming Mode bar code.

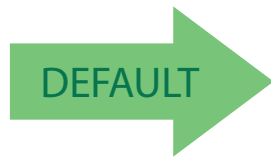

EAN-8 Guard Insertion = Disable



EAN-8 Guard Insertion = Enable

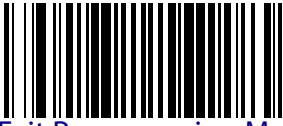

EAN-8/Jan-8 Both Guards Substitution

Enables/disables the ability of the scanner to find an EAN/JAN8 guard pattern in cases where the EAN/JAN8 margin makes the guard look like a character.

To set this feature:

1. Scan the Enter/Exit Programming Mode bar code.
2. Scan either the enable or disable bar code below. You'll need to cover any unused bar codes on this and the facing page to ensure that the scanner reads only the bar code you intend to scan.
3. Complete the programming sequence by scanning the Enter/Exit Programming Mode bar code.

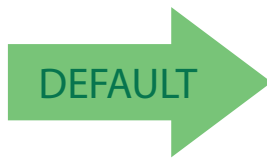

EAN-8/JAN-8 Both Guards Substitution = Disable



EAN-8/JAN-8 Both Guards Substitution = Enable

EAN-8 Stitch Exact Label Halves

This setting enables the stitching of exact EAN-8 label halves with no overlapping characters.

To set this feature:

1. Scan the Enter/Exit Programming Mode bar code.
2. Scan either the enable or disable bar code below. You'll need to cover any unused bar codes on this and the facing page to ensure that the scanner reads only the bar code you intend to scan.
3. Complete the programming sequence by scanning the Enter/Exit Programming Mode bar code.

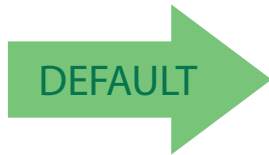

EAN-8 Stitch Exact Label Halves = Disable



EAN-8 Stitch Exact Label Halves = Enable

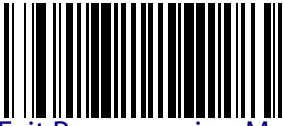

EAN-8 Stitch Unlike Label Halves

This setting enables the stitching of two EAN-8 label halves together that may have different characters.

To set this feature:

1. Scan the Enter/Exit Programming Mode bar code.
2. Scan either the enable or disable bar code below. You'll need to cover any unused bar codes on this and the facing page to ensure that the scanner reads only the bar code you intend to scan.
3. Complete the programming sequence by scanning the Enter/Exit Programming Mode bar code.

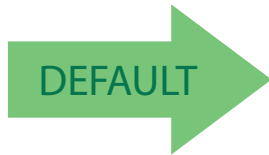

EAN-8 Stitch Unlike Label Halves = Disable

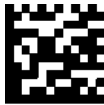

EAN-8 Stitch Unlike Label Halves = Enable

EAN-8 Minimum Segment Length

Specifies the minimum number of characters necessary in an EAN-8/JAN-8 label segment in order for the scanner to accept a label for decoding. Selectable from 5 to 15 characters. Default setting for this feature is: 08 (8 characters).



EAN-8 Minimum Segment Length = 5 characters



EAN-8 Minimum Segment Length = 6 characters



EAN-8 Minimum Segment Length = 7 characters



EAN-8 Minimum Segment Length = 8 characters



EAN-8 Minimum Segment Length = 9 characters



EAN-8 Minimum Segment Length = 10 characters



EAN-8 Minimum Segment Length = 11 characters



EAN-8 Minimum Segment Length (continued)



EAN-8 Minimum Segment Length = 12 characters



EAN-8 Minimum Segment Length = 13 characters



EAN-8 Minimum Segment Length = 14 characters



EAN-8 Minimum Segment Length = 15 characters

EAN-8 Decoding Levels

Decoding levels allow the decoder to be set to perform at one of four selectable levels:

- Very Conservative — Slower scan time, virtually eliminates misreads. The most secure setting.
- Slightly More Aggressive — Faster scanning, more aggressive, yet minimizes misreads.
- Moderately Aggressive — Even faster scanning, even more aggressive.
- Very Aggressive — Fastest scan speed, most aggressive.



Use caution when setting this feature, as more aggressive settings for this feature allow a higher potential for misreads.

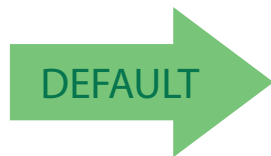

EAN-8 Decoding Level = Very Conservative



EAN-8 Decoding Level = Slightly More Aggressive



EAN-8 Decoding Level = Moderately Aggressive



EAN-8 Decoding Level = Very Aggressive

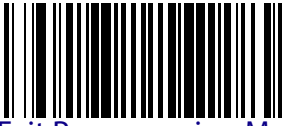

Other UPC/EAN Options

The following pages contain other selectable features for UPC/EAN symbolologies:

- In-Store Printed Label Minimum Read on page 135
- UPC/EAN Correlation on page 136
- UPC/EAN Guard Insertion on page 137
- UPC/EAN Stitch Exact Label Halves on page 138
- UPC/EAN Stitch Unlike Label Halves on page 139
- UPC/EAN Minimum Segment Length on page 140
- Price Weight Check on page 142
- Enable EAN Two Label on page 144
- Add-ons on page 147

In-Store Printed Label Minimum Read

This feature specifies the minimum number of consecutive In-Store Printed Label decodes before is accepted as good read.

To set this feature:

1. Scan the ENTER/EXIT Programming Mode bar code.
2. Scan your selection from the bar codes below. You'll need to cover any unused bar codes on this and the facing page to ensure that the scanner reads only the bar code you intend to scan.
3. Complete the programming sequence by scanning the ENTER/EXIT Programming Mode bar code.

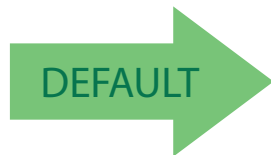

In-Store Printed Label Minimum Read = 1



In-Store Printed Label Minimum Read = 2



In-Store Printed Label Minimum Read = 3



In-Store Printed Label Minimum Read = 4



UPC/EAN Correlation

Enables/disables character correlation for UPC/EAN.

To set this feature:

1. Scan the ENTER/EXIT Programming Mode bar code.
2. Scan either the enable or disable bar code below. You'll need to cover any unused bar codes on this and the facing page to ensure that the scanner reads only the bar code you intend to scan.
3. Complete the programming sequence by scanning the ENTER/EXIT Programming Mode bar code.

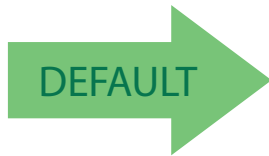

UPC/EAN Correlation = Disable



UPC/EAN Correlation = Enable

UPC/EAN Guard Insertion

This setting enables the insertion of either a missing leading or trailing guard to a scanned bar code.

To set this feature:

1. Scan the Enter/Exit Programming Mode bar code.
2. Scan either the enable or disable bar code below. You'll need to cover any unused bar codes on this and the facing page to ensure that the scanner reads only the bar code you intend to scan.
3. Complete the programming sequence by scanning the Enter/Exit Programming Mode bar code.

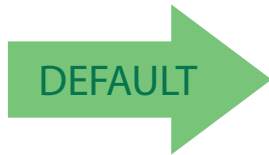

UPC/EAN Guard Insertion = Disable



UPC/EAN Guard Insertion = Enable

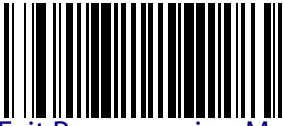

UPC/EAN Stitch Exact Label Halves

This setting enables the stitching of exact UPC-A/EAN-13 label halves with no overlapping characters.

To set this feature:

1. Scan the Enter/Exit Programming Mode bar code.
2. Scan either the enable or disable bar code below. You'll need to cover any unused bar codes on this and the facing page to ensure that the scanner reads only the bar code you intend to scan.
3. Complete the programming sequence by scanning the Enter/Exit Programming Mode bar code.

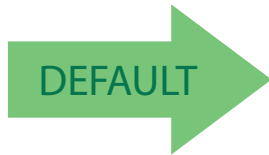

UPC/EAN Stitch Exact Label Halves = Disable



UPC/EAN Stitch Exact Label Halves = Enable

UPC/EAN Stitch Unlike Label Halves

This setting enables the stitching of two UPC-A/EAN-13 label halves together that may have different characters.

To set this feature:

1. Scan the Enter/Exit Programming Mode bar code.
2. Scan either the enable or disable bar code below. You'll need to cover any unused bar codes on this and the facing page to ensure that the scanner reads only the bar code you intend to scan.
3. Complete the programming sequence by scanning the Enter/Exit Programming Mode bar code.

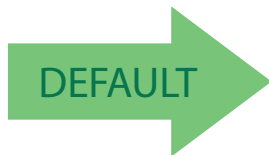

UPC/EAN Stitch Unlike Label Halves = Disable



UPC/EAN Stitch Unlike Label Halves = Enable

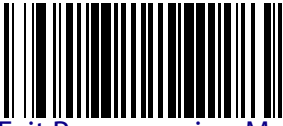

UPC/EAN Minimum Segment Length

This feature specifies the minimum number of characters needed in a UPC/EAN segment in order to be accepted for decoding.

To set this feature:

1. Scan the Enter/Exit Programming Mode bar code.
2. Scan the bar code for the desired setting below. You'll need to cover any unused bar codes on this and the facing page to ensure that the scanner reads only the bar code you intend to scan.
3. Complete the programming sequence by scanning the Enter/Exit Programming Mode bar code.

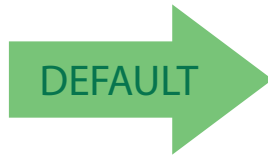

UPC/EAN Minimum Segment Length = 5 Characters



UPC/EAN Minimum Segment Length = 6 Characters



UPC/EAN Minimum Segment Length = 7 Characters



UPC/EAN Minimum Segment Length = 8 Characters



UPC/EAN Minimum Segment Length = 9 Characters

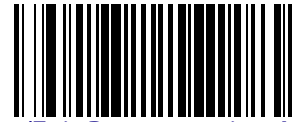

UPC/EAN Minimum Segment Length (continued)



UPC/EAN Minimum Segment Length = 10 Characters



UPC/EAN Minimum Segment Length = 11 Characters



UPC/EAN Minimum Segment Length = 12 Characters



UPC/EAN Minimum Segment Length = 13 Characters



UPC/EAN Minimum Segment Length = 14 Characters



UPC/EAN Minimum Segment Length = 15 Characters



Price Weight Check

Enables/disables calculation and verification of price/weight check digits. Applies to all UPC-A and EAN/JAN-13 labels with eligible¹ Number System/First Character digits.

Options are:

- Disable
- 4-digit price/weight
- 5-digit price/weight
- 4-digit European price/weight
- 5-digit European price/weight

To set this feature:

1. Scan the Enter/Exit Programming Mode bar code.
2. Scan the bar code representing the desired option below or on the following pages. You'll need to cover any unused bar codes on facing pages to ensure that the scanner reads only the bar code you intend to scan.
3. Complete the programming sequence by scanning the Enter/Exit Programming Mode bar code.

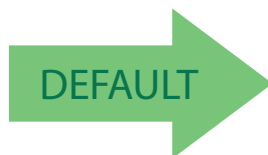

Price Weight Check = Disable



Price Weight Check = 4-digit price/weight



Price Weight Check = 5-digit price/weight

1. Price Weight Check generally applies to UPC-A labels with a Number System Digit of 2 and EAN/JAN-13 labels with a First Character of 2. There are a total of six flag digits corresponding to the six types. Checking applies depending upon which type is enabled.

Price Weight Check (continued)



Price Weight Check = 4-digit European price/weight



Price Weight Check = 5-digit European price/weight



Enable EAN Two Label

Enables/disables the ability of the scanner to decode EAN two-label pairs.
To set this feature:

1. Scan the Enter/Exit Programming Mode bar code.
2. Scan either the enable or disable bar code below. You'll need to cover any unused bar codes on this and the facing page to ensure that the scanner reads only the bar code you intend to scan.
3. Complete the programming sequence by scanning the Enter/Exit Programming Mode bar code.



NOTE

Contact Customer Support for details about advanced programming for this feature.

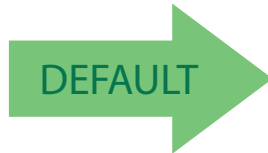

EAN Two Label = Disable



EAN Two Label = Enable

EAN Two Label Minimum Read

This feature specifies the minimum number of consecutive EAN Two Label decodes before is accepted as good read.

To set this feature:

1. Scan the ENTER/EXIT Programming Mode bar code.
2. Scan your selection from the bar codes below. You'll need to cover any unused bar codes on this and the facing page to ensure that the scanner reads only the bar code you intend to scan.
3. Complete the programming sequence by scanning the ENTER/EXIT Programming Mode bar code.

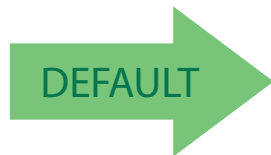

EAN Two Label Minimum Read = 1



EAN Two Label Minimum Read = 2



EAN Two Label Minimum Read = 3



EAN Two Label Minimum Read = 4

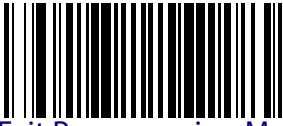

EAN Two Label Combined Transmission

Enables/disables the transmitting of an EAN two label pair as one label.

To set this feature:

1. Scan the Enter/Exit Programming Mode bar code.
2. Scan either the enable or disable bar code below. You'll need to cover any unused bar codes on this and the facing page to ensure that the scanner reads only the bar code you intend to scan.
3. Complete the programming sequence by scanning the Enter/Exit Programming Mode bar code.

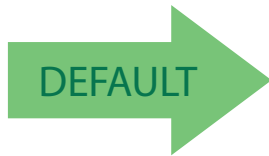

EAN Two Label Combined Transmission = Disable



EAN Two Label Combined Transmission = Enable

Add-ons

The scanner is capable of processing different types of add-on codes, including:

- 2-Digit Supplemental
- 5-Digit Supplemental

Options are provided on the following pages for your convenience:

- Disable all add-ons — The scanner will not look for or read add-ons.
- Optional 2-Digit and 5-Digit Supplemental — Bar Codes can be read which include 2-Digit or 5-Digit Supplementals, however, it is not required that add-ons be included in bar codes.



Contact customer support for advanced programming of optional and conditional add-ons.

NOTE

To set this feature:

1. Scan the Enter/Exit Programming Mode bar code.
2. Scan the bar code representing the desired option on this and the following page. You'll need to cover any unused bar codes on facing pages to ensure that the scanner reads only the bar code you intend to scan.
3. Complete the programming sequence by scanning the Enter/Exit Programming Mode bar code.

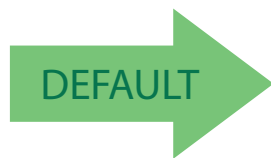

Add-ons = Disable All Add-ons



Add-ons = Optional 2-Digit and 5-Digit Supplemental



P2 Add-on Minimum Read

This feature specifies the minimum number of times a P2 add-on must decode before it is marked valid.

To set this feature:

1. Scan the Enter/Exit Programming Mode bar code.
2. Scan the bar code representing the desired option on this and the following page. You'll need to cover any unused bar codes on facing pages to ensure that the scanner reads only the bar code you intend to scan.
3. Complete the programming sequence by scanning the Enter/Exit Programming Mode bar code.

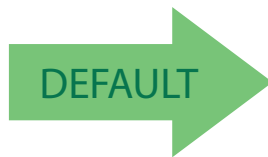

P2 Add-on Minimum Read = 2



P2 Add-on Minimum Read = 3



P2 Add-on Minimum Read = 4



P2 Add-on Minimum Read = 5



P2 Add-on Minimum Read = 6

P2 Add-on Minimum Read (continued)



P2 Add-on Minimum Read = 7



P2 Add-on Minimum Read = 8



P2 Add-on Minimum Read = 9



P2 Add-on Minimum Read = 10



P2 Add-on Minimum Read = 11



P2 Add-on Minimum Read = 12



P2 Add-on Minimum Read = 13



P2 Add-on Minimum Read (continued)



P2 Add-on Minimum Read = 14



P2 Add-on Minimum Read = 15

P5 Add-on Minimum Read

This feature specifies the minimum number of times a P5 add-on must decode before it is marked valid.

To set this feature:

1. Scan the Enter/Exit Programming Mode bar code.
2. Scan the bar code representing the desired option on this and the following page. You'll need to cover any unused bar codes on facing pages to ensure that the scanner reads only the bar code you intend to scan.
3. Complete the programming sequence by scanning the Enter/Exit Programming Mode bar code.



P5 Add-on Minimum Read = 1



DEFAULT



P5 Add-on Minimum Read = 2



P5 Add-on Minimum Read = 3



P5 Add-on Minimum Read = 4



P5 Add-on Minimum Read = 5



P5 Add-on Minimum Read = 6

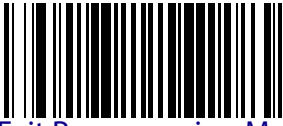

P5 Add-on Minimum Read (continued)



P5 Add-on Minimum Read = 7



P5 Add-on Minimum Read = 8



P5 Add-on Minimum Read = 9



P5 Add-on Minimum Read = 10



P5 Add-on Minimum Read = 11



P5 Add-on Minimum Read = 12



P5 Add-on Minimum Read = 13

P5 Add-on Minimum Read (continued)



P5 Add-on Minimum Read = 14



P5 Add-on Minimum Read = 15



UPC/EAN Composites

Enables/Disables Composites for the UPC/EAN families of labels.

Options are:

To set this feature:

1. Scan the Enter/Exit Programming Mode bar code.
2. Scan the bar code below. You'll need to cover any unused bar codes on this and the facing page to ensure that the scanner reads only the bar code you intend to scan.
3. Scan the appropriate digits from the [Alpha-Numeric Keypad on page 283](#) that represent the desired number. The selectable range is 0–15 resets. Pad all single and double digit numbers with leading zeroes to yield a two-digit entry (00–15).
4. Complete the programming sequence by scanning the Enter/Exit Programming Mode bar code.



SetUPC/EAN Composites



Default setting for this feature is:
00 - Disabled

GTIN

GTIN Enable

Enables/Disables the ability to convert UPCE, UPCA, EAN8, and EAN13 labels into the GTIN 14-character format.



NOTE

If add-on information is present on the base label prior to the conversion taking place, the add-on information will be appended to the converted GTIN bar code.

To set this feature:

1. Scan the Enter/Exit Programming Mode bar code.
2. Scan either the enable or disable bar code below. You'll need to cover any unused bar codes on this and the facing page to ensure that the scanner reads only the bar code you intend to scan.
3. Complete the programming sequence by scanning the Enter/Exit Programming Mode bar code.

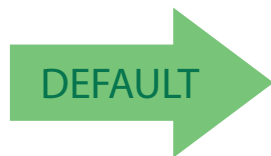

GTIN = Disable



GTIN = Enable



GS1 DataBar

The symbology family GS1 DataBar™ was formerly known as Reduced Space Symbology (RSS). For the purpose of simplicity, GS1 DataBar variants are listed in this manual as “DataBar.”

DataBar Omnidirectional

DataBar Omnidirectional Enable

Enables/disables the ability of the scanner to decode DataBar Omnidirectional labels.



NOTE

This value-added feature is a factory-programmed option. Contact your dealer for information about upgrading your system to include this advanced capability.

To set this feature:

1. Scan the ENTER/EXIT Programming Mode bar code.
2. Scan either the enable or disable bar code below. You’ll need to cover any unused bar codes on this and the facing page to ensure that the scanner reads only the bar code you intend to scan.
3. Complete the programming sequence by scanning the ENTER/EXIT Programming Mode bar code.



DataBar Omnidirectional = Disable



DataBar Omnidirectional = Enable

DataBar Omnidirectional/EAN-128 Emulation

Enables/disables the ability of DataBar Omnidirectional to be transmitted as EAN-128.

1. To set this feature:
2. Scan the ENTER/EXIT Programming Mode bar code.
3. Scan either the enable or disable bar code below. You'll need to cover any unused bar codes on this and the facing page to ensure that the scanner reads only the bar code you intend to scan.
4. Complete the programming sequence by scanning the ENTER/EXIT Programming Mode bar code.

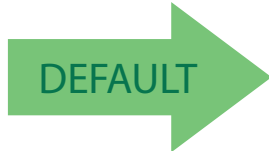

DataBar Omnidirectional/EAN-128 Emulation =
Disable



DataBar Omnidirectional/EAN-128 Emulation = Enable

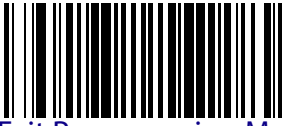

DataBar Omnidirectional 2D Component Enable

When this feature is enabled, the software will not decode an DataBar Omnidirectional bar code with a 2D component associated with it, and the 2D component will be discarded.

To set this feature:

1. Scan the ENTER/EXIT Programming Mode bar code.
2. Scan your selection from the bar codes below. You'll need to cover any unused bar codes on this and the facing page to ensure that the scanner reads only the bar code you intend to scan.
3. Complete the programming sequence by scanning the ENTER/EXIT Programming Mode bar code.

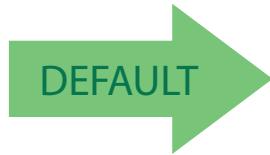

DataBar Omnidirectional 2D Component = Disable



DataBar Omnidirectional 2D Component = Enable

DataBar Omnidirectional Minimum Read

This feature specifies the minimum number of consecutive DataBar Omnidirectional decodes before is accepted as good read.

To set this feature:

1. Scan the ENTER/EXIT Programming Mode bar code.
2. Scan your selection from the bar codes below. You'll need to cover any unused bar codes on this and the facing page to ensure that the scanner reads only the bar code you intend to scan.
3. Complete the programming sequence by scanning the ENTER/EXIT Programming Mode bar code.

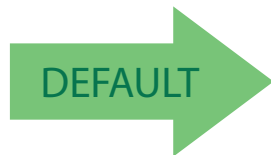

DataBar Omnidirectional Minimum Read = 1



DataBar Omnidirectional Minimum Read = 2



DataBar Omnidirectional Minimum Read = 3



DataBar Omnidirectional Minimum Read = 4



DataBar Omnidirectional Double Read Timeout

Specifies the minimum allowable time which must pass before reading the same DataBar Omnidirectional label again (e.g. two identical items in succession).

To set this feature:

1. Scan the Enter/Exit Programming Mode bar code.
2. Scan your selection from the bar codes below. You'll need to cover any unused bar codes on this and the facing page to ensure that the scanner reads only the bar code you intend to scan.
3. Complete the programming sequence by scanning the Enter/Exit Programming Mode bar code.



DataBar Omnidirectional Double Read
Timeout = 0.5 Seconds



DataBar Omnidirectional Double Read
Timeout = 1 Second

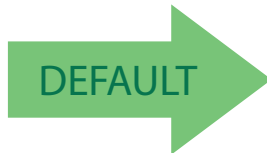

DataBar Omnidirectional Double Read
Timeout = 2.5 Seconds

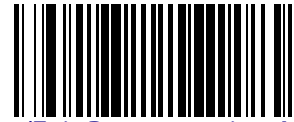

DataBar Omnidirectional Double Read Timeout (continued)



DataBar Omnidirectional Double Read
Timeout = 3 Seconds



DataBar Omnidirectional Double Read
Timeout = 3.5 Seconds

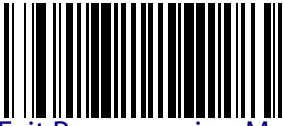

DataBar Limited

DataBar Limited Enable

Enables/disables the ability of the scanner to decode DataBar Limited labels.

To set this feature:

1. Scan the ENTER/EXIT Programming Mode bar code.
2. Scan either the enable or disable bar code below. You'll need to cover any unused bar codes on this and the facing page to ensure that the scanner reads only the bar code you intend to scan.
3. Complete the programming sequence by scanning the ENTER/EXIT Programming Mode bar code.

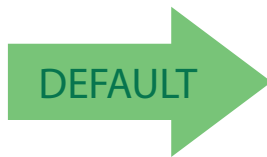

Databar Limited = Disable



Databar Limited = Enable

DataBar Limited Minimum Read

This feature specifies the minimum number of consecutive Databar Limited decodes before is accepted as good read.

To set this feature:

1. Scan the ENTER/EXIT Programming Mode bar code.
2. Scan either the enable or disable bar code below. You'll need to cover any unused bar codes on this and the facing page to ensure that the scanner reads only the bar code you intend to scan.
3. Complete the programming sequence by scanning the ENTER/EXIT Programming Mode bar code.

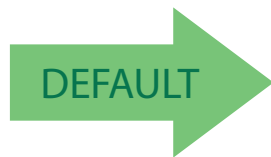

Databar Limited Minimum Read = 1



Databar Limited Minimum Read = 2



Databar Limited Minimum Read = 3



Databar Limited Minimum Read = 4

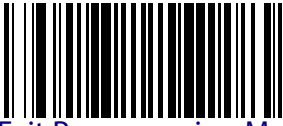

DataBar Limited 2D Component Enable

This feature controls if a 2D label component be decoded when a Databar Limited base label is decoded.

To set this feature:

1. Scan the ENTER/EXIT Programming Mode bar code.
2. Scan either the enable or disable bar code below. You'll need to cover any unused bar codes on this and the facing page to ensure that the scanner reads only the bar code you intend to scan.
3. Complete the programming sequence by scanning the ENTER/EXIT Programming Mode bar code.

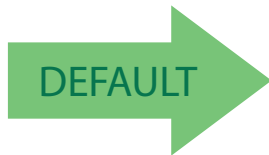

DataBar Limited 2D Component = Disable



DataBar Limited 2D Component = Enable

DataBar Limited EAN128 Emulation Enable

Enables/disables GS1–EAN128 emulation for GS1 Databar Limited.

To set this feature:

1. Scan the ENTER/EXIT Programming Mode bar code.
2. Scan either the enable or disable bar code below. You'll need to cover any unused bar codes on this and the facing page to ensure that the scanner reads only the bar code you intend to scan.
3. Complete the programming sequence by scanning the ENTER/EXIT Programming Mode bar code.

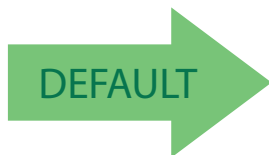

Databar Limited EAN128 Emulation = disable



Databar Limited EAN128 Emulation = enable



DataBar Expanded

DataBar Expanded Enable

Enables/disables the ability of the scanner to decode DataBar Expanded labels.



NOTE

This value-added feature is a factory-programmed option. Contact your dealer for information about upgrading your system to include this advanced capability.

To set this feature:

1. Scan the ENTER/EXIT Programming Mode bar code.
2. Scan either the enable or disable bar code below. You'll need to cover any unused bar codes on this and the facing page to ensure that the scanner reads only the bar code you intend to scan.
3. Complete the programming sequence by scanning the ENTER/EXIT Programming Mode bar code.

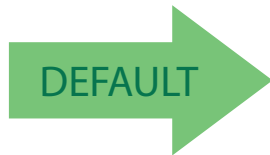

DataBar Expanded = Disable



DataBar Expanded = Enable

DataBar Expanded EAN-128 Emulation

Enables/disables EAN 128 emulation for DataBar Expanded.

To set this feature:

1. Scan the ENTER/EXIT Programming Mode bar code.
2. Scan either the enable or disable bar code below. You'll need to cover any unused bar codes on this and the facing page to ensure that the scanner reads only the bar code you intend to scan.
3. Complete the programming sequence by scanning the ENTER/EXIT Programming Mode bar code.

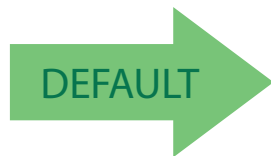

DataBar Expanded EAN-128 Emulation = Disable



DataBar Expanded EAN-128 Emulation = Enable

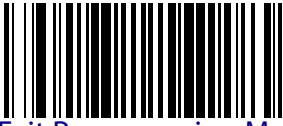

DataBar Expanded 2D Component Enable

When this feature is enabled, the software will not decode an DataBar Expanded bar code with a 2D component associated with it, and the 2D component will be discarded.

To set this feature:

1. Scan the ENTER/EXIT Programming Mode bar code.
2. Scan your selection from the bar codes below. You'll need to cover any unused bar codes on this and the facing page to ensure that the scanner reads only the bar code you intend to scan.
3. Complete the programming sequence by scanning the ENTER/EXIT Programming Mode bar code.

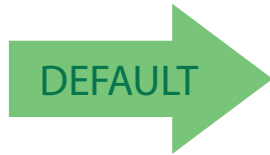

DataBar Expanded 2D Component = Disable



DataBar Expanded 2D Component = Enable

DataBar Expanded Minimum Read

This feature specifies the minimum number of consecutive DataBar Expanded decodes before is accepted as good read.

To set this feature:

1. Scan the ENTER/EXIT Programming Mode bar code.
2. Scan your selection from the bar codes below. You'll need to cover any unused bar codes on this and the facing page to ensure that the scanner reads only the bar code you intend to scan.
3. Complete the programming sequence by scanning the ENTER/EXIT Programming Mode bar code.

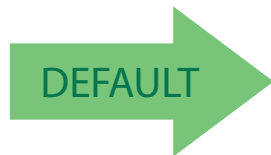

DataBar Expanded Minimum Read = 1



DataBar Expanded Minimum Read = 2



DataBar Expanded Minimum Read = 3



DataBar Expanded Minimum Read = 4

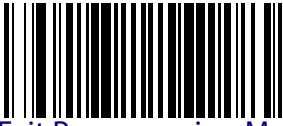

DataBar Expanded Length Control

This feature specifies either variable-length or fixed-length decoding for DataBar Expanded.

To set this feature:

1. Scan the ENTER/EXIT Programming Mode bar code.
2. Scan your selection from the bar codes below. You'll need to cover any unused bar codes on this and the facing page to ensure that the scanner reads only the bar code you intend to scan.
3. Complete the programming sequence by scanning the ENTER/EXIT Programming Mode bar code.

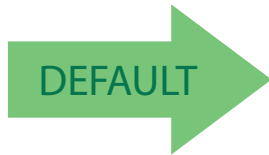

DataBar Expanded Length Control = Variable Length



DataBar Expanded Length Control = Fixed Length

DataBar Expanded Length 1

Length 1 is the minimum label length if in variable length mode, or the first fixed length if in fixed length mode. Length includes the bar code's data characters only.

To set this feature:

1. Scan the ENTER/EXIT Programming Mode bar code.
2. Scan the bar code, [Set DataBar Expanded Length 1 on page 171](#) below. You'll need to cover any unused bar codes on this and the facing page to ensure that the scanner reads only the bar code you intend to scan.
3. Scan the appropriate digits from the [Alpha-Numeric Keypad in Appendix C](#) that represent the desired label length. The selectable range for this option is 00 to 74. Pad all single digit numbers with a leading zero to yield a two-digit entry (00-74).
4. Complete the programming sequence by scanning the ENTER/EXIT Programming Mode bar code.



Set DataBar Expanded Length 1

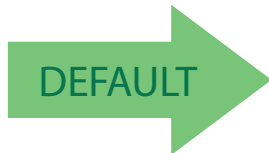

Default setting for this feature = 01

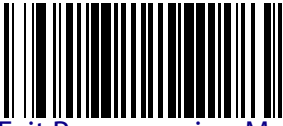

DataBar Expanded Length 2

Length 2 is the maximum label length if in variable length mode, or the second fixed length if in fixed length mode. Length includes the bar code's data characters only.



NOTE

When in Fixed Length mode, if Length 2 is set to the value of 00 (zero), then only Length 1 will apply.

To set this feature:

1. Scan the ENTER/EXIT Programming Mode bar code.
2. Scan the bar code, [Set DataBar Expanded Length 2 on page 172](#) below. You'll need to cover any unused bar codes on this and the facing page to ensure that the scanner reads only the bar code you intend to scan.
3. Scan the appropriate digits from the [Alpha-Numeric Keypad in Appendix C](#) that represent the desired label length. The selectable range for this option is 00 to 74. Pad all single digit numbers with a leading zero to yield a two-digit entry (00-74).
4. Complete the programming sequence by scanning the ENTER/EXIT Programming Mode bar code.



Set DataBar Expanded Length 2

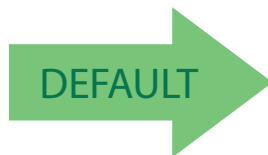

Default setting for this feature = 4A (length = 74)

DataBar Expanded Reverse Retry

Enables/disables the reading of out of specification labels where the last row has been printed in reverse.

- When enabled, DataBar Expanded Stacked labels that have the last row incorrectly printed in reverse will be re-decoded.
- When disabled, DataBar Expanded Stacked labels that have the last row incorrectly printed in reverse will not be read.

To set this feature:

1. Scan the ENTER/EXIT Programming Mode bar code.
2. Scan your selection from the bar codes below. You'll need to cover any unused bar codes on this and the facing page to ensure that the scanner reads only the bar code you intend to scan.
3. Complete the programming sequence by scanning the ENTER/EXIT Programming Mode bar code.

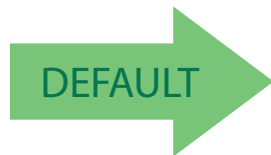

DataBar Expanded Reverse Retry = Disable



DataBar Expanded Reverse Retry = Enable

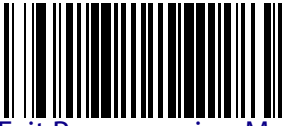

Code 39

Code 39 Enable

Enables/disables the ability of the scanner to decode Code 39 labels.

To set this feature:

1. Scan the ENTER/EXIT Programming Mode bar code.
2. Scan either the enable or disable bar code below. You'll need to cover any unused bar codes on this and the facing page to ensure that the scanner reads only the bar code you intend to scan.
3. Complete the programming sequence by scanning the ENTER/EXIT Programming Mode bar code.



Code 39 = Disable



Code 39 = Enable



Code 39 Start Stop Character Transmission

Enables/disables transmission of Code 39 start and stop characters.



This item is ignored when the advanced feature, Full Label Edit, is enabled

NOTE

To set this feature:

1. Scan the ENTER/EXIT Programming Mode bar code.
2. Scan either the enable or disable bar code below. You'll need to cover any unused bar codes on this and the facing page to ensure that the scanner reads only the bar code you intend to scan.
3. Complete the programming sequence by scanning the ENTER/EXIT Programming Mode bar code.

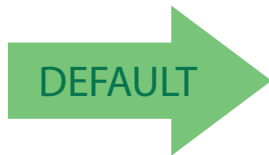

Code 39 Start Stop Character Transmission = Disable



Code 39 Start Stop Character Transmission = Enable

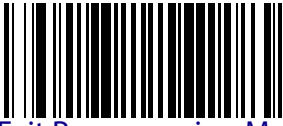

Code 39 Check Character Calculation

Enables/disables calculation and verification of an optional Code 39 check character. When disabled, any check character in label is treated as a data character.



NOTE

If check calculation is disabled, the risk is increased that a misread can occur.

To set this feature:

1. Scan the ENTER/EXIT Programming Mode bar code.
2. Scan either the enable or disable bar code below. You'll need to cover any unused bar codes on this and the facing page to ensure that the scanner reads only the bar code you intend to scan.
3. Complete the programming sequence by scanning the ENTER/EXIT Programming Mode bar code.

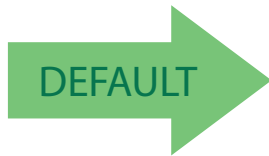

Code 39 Check Character Calculation = Disable



Code 39 Check Character Calculation = Enable

Code 39 Check Character Transmission

Enables/disables transmission of optional Code 39 check character.



This item is ignored when the advanced feature, Full Label Edit, is enabled.

NOTE

To set this feature:

1. Scan the ENTER/EXIT Programming Mode bar code.
2. Scan either the enable or disable bar code below. You'll need to cover any unused bar codes on this and the facing page to ensure that the scanner reads only the bar code you intend to scan.
3. Complete the programming sequence by scanning the ENTER/EXIT Programming Mode bar code.



Code 39 Check Character Transmission = Disable



Code 39 Check Character Transmission = Enable



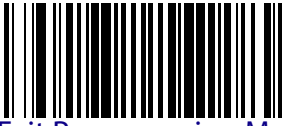

Code 39 Full ASCII

Enables/disables the ability of the scanner to translate to Code 39 full ASCII labels.

To set this feature:

1. Scan the ENTER/EXIT Programming Mode bar code.
2. Scan either the enable or disable bar code below. You'll need to cover any unused bar codes on this and the facing page to ensure that the scanner reads only the bar code you intend to scan.
3. Complete the programming sequence by scanning the ENTER/EXIT Programming Mode bar code.

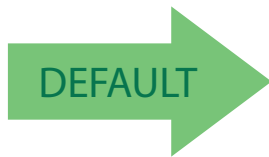

Code 39 Full ASCII = Disable



Code 39 Full ASCII = Enable

Code 39 Minimum Read

This feature specifies the minimum number of consecutive Code 39 decodes before is accepted as good read.

To set this feature:

1. Scan the ENTER/EXIT Programming Mode bar code.
2. Scan your selection from the bar codes below. You'll need to cover any unused bar codes on this and the facing page to ensure that the scanner reads only the bar code you intend to scan.
3. Complete the programming sequence by scanning the ENTER/EXIT Programming Mode bar code.

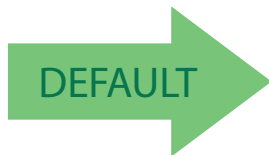

Code 39 Minimum Read = 1



Code 39 Minimum Read = 2



Code 39 Minimum Read = 3



Code 39 Minimum Read = 4

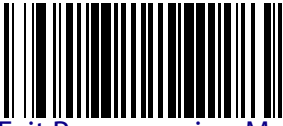

Code 39 Correlation

Enables/disables character correlation for Code 39.

To set this feature:

1. Scan the ENTER/EXIT Programming Mode bar code.
2. Scan either the enable or disable bar code below. You'll need to cover any unused bar codes on this and the facing page to ensure that the scanner reads only the bar code you intend to scan.
3. Complete the programming sequence by scanning the ENTER/EXIT Programming Mode bar code.

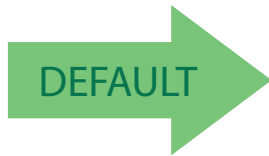

Code 39 Correlation = Disable



Code 39 Correlation = Enable

Code 39 Length Control

This feature specifies whether variable-length or fixed-length decoding will be set for Code 39.

To set this feature:

1. Scan the ENTER/EXIT Programming Mode bar code.
2. Scan your selection from the bar codes below. You'll need to cover any unused bar codes on this and the facing page to ensure that the scanner reads only the bar code you intend to scan.
3. Complete the programming sequence by scanning the ENTER/EXIT Programming Mode bar code.

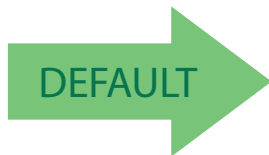

Code 39 Length Control = Variable Length



Code 39 Length Control = Fixed Length

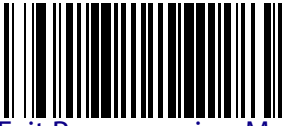

Code 39 Length 1

If Code 39 Length Control is set to Fixed–Length decoding, this feature specifies Code 39 first fixed length. If Code 39 Length Control is set to Variable–Length decoding, this feature specifies the minimum label length.

To set this feature:

1. Scan the ENTER/EXIT Programming Mode bar code.
2. Scan the bar code, [Set Code 39 Length 1 on page 182](#) below. You’ll need to cover any unused bar codes on this and the facing page to ensure that the scanner reads only the bar code you intend to scan.
3. Scan the appropriate digits from the [Alpha–Numeric Keypad in Appendix C](#) that represent the desired label length. The selectable range for this option is 00 to 50. Pad all single digit numbers with a leading zero to yield a two–digit entry (00–50).
4. Complete the programming sequence by scanning the ENTER/EXIT Programming Mode bar code.



Set Code 39 Length 1

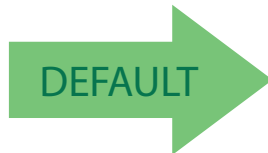

Default setting for this feature = 02

Code 39 Length 2

If Code 39 Length Control is set to Fixed–Length decoding, this feature specifies Code 39 second fixed length. If Code 39 Length Control is set to Variable–Length decoding, this feature specifies the maximum label length.



NOTE

When in Fixed Length mode, if Length 2 is set to the value of 00, then only Length 1 will apply

To set this feature:

1. Scan the ENTER/EXIT Programming Mode bar code.
2. Scan the bar code, [Set Code 39 Length 2 on page 183](#) below. You'll need to cover any unused bar codes on this and the facing page to ensure that the scanner reads only the bar code you intend to scan.
3. Scan the appropriate digits from the [Alpha–Numeric Keypad in Appendix C](#) that represent the desired label length. The selectable range for this option is 00, no second fixed length, or 01 to 50. Pad all single digit numbers with a leading zero to yield a two–digit entry (00–50).
4. Complete the programming sequence by scanning the ENTER/EXIT Programming Mode bar code.



Set Code 39 Length 2

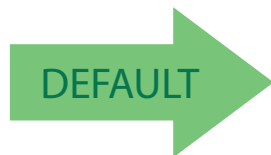

Default setting for this feature = 32 (length = 50)

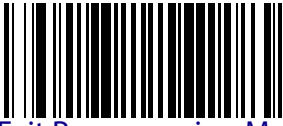

Code 39 Stitching

Enables/disables stitching for Code 39 labels. When parts of a Code 39 bar code are presented to the scanner with this feature enabled, the bar code parts will be assembled by the scanner's software, and the data will be decoded if all bar code proofing requirements are met.

To set this feature:

1. Scan the ENTER/EXIT Programming Mode bar code.
2. Scan your selection from the bar codes below. You'll need to cover any unused bar codes on this and the facing page to ensure that the scanner reads only the bar code you intend to scan.
3. Complete the programming sequence by scanning the ENTER/EXIT Programming Mode bar code.



Code 39 Stitching = Disable



Code 39 Stitching = Enable



Code 39 Require Margins

Enables/disables the requirement that quiet zones be present in a Code 39 bar code.

To set this feature:

1. Scan the ENTER/EXIT Programming Mode bar code.
2. Scan either the enable or disable bar code below. You'll need to cover any unused bar codes on this and the facing page to ensure that the scanner reads only the bar code you intend to scan.
3. Complete the programming sequence by scanning the ENTER/EXIT Programming Mode bar code.

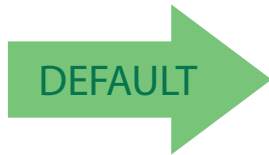

Code 39 Require Margins = Quiet Zones Not Required



Code 39 Require Margins = Quiet Zones Required



Code 32 Italian Pharmacode

Code 32 Italian Pharmacode Enable

Enables/disables the ability of the scanner to decode Italian Pharmaceutical Code 39 labels.

To set this feature:

1. Scan the ENTER/EXIT Programming Mode bar code.
2. Scan either the enable or disable bar code below. You'll need to cover any unused bar codes on this and the facing page to ensure that the scanner reads only the bar code you intend to scan.
3. Complete the programming sequence by scanning the ENTER/EXIT Programming Mode bar code.

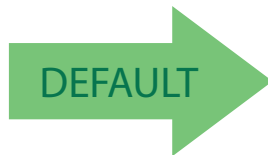

Code 32 Italian Pharmacode Enable = Disable



Code 32 Italian Pharmacode Enable = Enable

Code 32 Start Stop Character Transmission

Enables/ disables transmission of start and stop characters for Code 32.



This item is ignored when the advanced feature, Full Label Edit, is enabled.

NOTE

To set this feature:

1. Scan the ENTER/EXIT Programming Mode bar code.
2. Scan either the enable or disable bar code below. You'll need to cover any unused bar codes on this and the facing page to ensure that the scanner reads only the bar code you intend to scan.
3. Complete the programming sequence by scanning the ENTER/EXIT Programming Mode bar code.

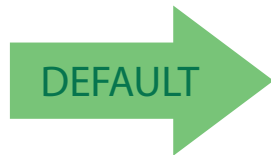

Code 32 Start Stop Character Transmission = Disable



Code 32 Start Stop Character Transmission = Enable

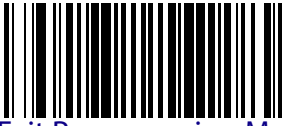

Code 32 Check Character Transmission

Enables/disables transmission of Code 32 check character.



NOTE

This item is ignored when the advanced feature, Full Label Edit, is enabled.

To set this feature:

1. Scan the ENTER/EXIT Programming Mode bar code.
2. Scan either the enable or disable bar code below. You'll need to cover any unused bar codes on this and the facing page to ensure that the scanner reads only the bar code you intend to scan.
3. Complete the programming sequence by scanning the ENTER/EXIT Programming Mode bar code.

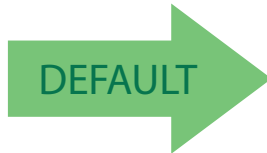

Code 32 Check Character Transmission = Disable



Code 32 Check Character Transmission = Enable

Code 128

Code 128 Enable

Enables/disables the ability of the scanner to decode Code 128 labels.
To set this feature:

1. Scan the ENTER/EXIT Programming Mode bar code.
2. Scan either the enable or disable bar code below. You'll need to cover any unused bar codes on this and the facing page to ensure that the scanner reads only the bar code you intend to scan.
3. Complete the programming sequence by scanning the ENTER/EXIT Programming Mode bar code.



Code 128 = Disable



Code 128 = Enable



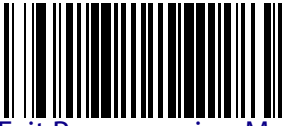

Code 128 Transmit Function Characters

Enables/disables transmission of Code 128 function characters 1, 2, 3, and 4.



NOTE

Disabled is the recommended setting for all interfaces.

To set this feature:

1. Scan the ENTER/EXIT Programming Mode bar code.
2. Scan either the enable or disable bar code below. You'll need to cover any unused bar codes on this and the facing page to ensure that the scanner reads only the bar code you intend to scan.
3. Complete the programming sequence by scanning the ENTER/EXIT Programming Mode bar code.

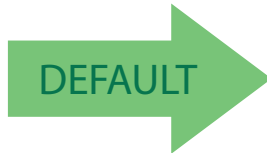

Code 128 Transmit Function Characters = Disable



Code 128 Transmit Function Characters = Enable

Expand Code128 to Code 39

Enables/disables expansion of Code 128 labels to Code 39.

To set this feature:

1. Scan the ENTER/EXIT Programming Mode bar code.
2. Scan either the enable or disable bar code below. You'll need to cover any unused bar codes on this and the facing page to ensure that the scanner reads only the bar code you intend to scan.
3. Complete the programming sequence by scanning the ENTER/EXIT Programming Mode bar code.

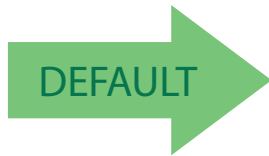

Expand Code128 to Code 39 = Disable

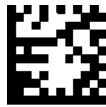

Expand Code128 to Code 39 = Enable

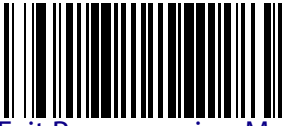

Code 128 Minimum Read

This feature specifies the minimum number of consecutive Code 128 decodes before is accepted as good read.

To set this feature:

1. Scan the ENTER/EXIT Programming Mode bar code.
2. Scan your selection from the bar codes below. You'll need to cover any unused bar codes on this and the facing page to ensure that the scanner reads only the bar code you intend to scan.
3. Complete the programming sequence by scanning the ENTER/EXIT Programming Mode bar code.

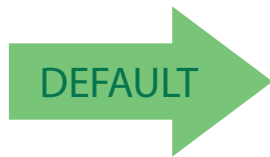

Code 128 Minimum Read = 1



Code 128 Minimum Read = 2



Code 128 Minimum Read = 3



Code 128 Minimum Read = 4

Code 128 Correlation

Enables/disables character correlation for Code 128.

To set this feature:

1. Scan the ENTER/EXIT Programming Mode bar code.
2. Scan either the enable or disable bar code below. You'll need to cover any unused bar codes on this and the facing page to ensure that the scanner reads only the bar code you intend to scan.
3. Complete the programming sequence by scanning the ENTER/EXIT Programming Mode bar code.

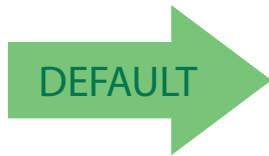

Code 128 Correlation = Disable



Code 128 Correlation = Enable

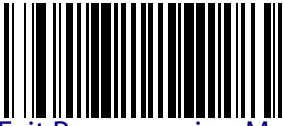

Code 128 Length Control

This feature specifies whether variable-length or fixed-length decoding will be set for Code 128.

To set this feature:

1. Scan the ENTER/EXIT Programming Mode bar code.
2. Scan your selection from the bar codes below. You'll need to cover any unused bar codes on this and the facing page to ensure that the scanner reads only the bar code you intend to scan.
3. Complete the programming sequence by scanning the ENTER/EXIT Programming Mode bar code.

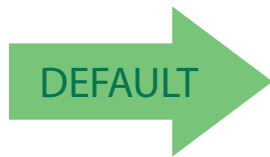

Code 128 Length Control = Variable Length



Code 128 Length Control = Fixed Length

Code 128 Length 1

If Code 128 Length Control is set to Fixed–Length decoding, this feature specifies Code 128 first fixed length. If Code 128 Length Control is set to Variable–Length decoding, this feature specifies the minimum label length.

To set this feature:

1. Scan the ENTER/EXIT Programming Mode bar code.
2. Scan the bar code, [Set Code 128 Length 1 on page 195](#) below. You'll need to cover any unused bar codes on this and the facing page to ensure that the scanner reads only the bar code you intend to scan.
3. Scan the appropriate digits from the [Alpha–Numeric Keypad in Appendix C](#) that represent the desired label length. The selectable range for this option is 01 to 80. Pad all single digit numbers with a leading zero to yield a two–digit entry (01–80).
4. Complete the programming sequence by scanning the ENTER/EXIT Programming Mode bar code.



Set Code 128 Length 1

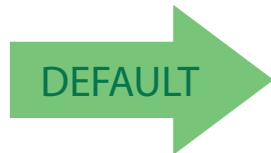

Default setting for this feature = 01



Code 128 Length 2

If Code 128 Length Control is set to Fixed–Length decoding, this feature specifies Code 128 second fixed length. If Code 128 Length Control is set to Variable–Length decoding, this feature specifies the maximum label length.



NOTE

When in Fixed Length mode, if Length 2 is set to the value of 00 (zero), then only Length 1 will apply.

To set this feature:

1. Scan the ENTER/EXIT Programming Mode bar code.
2. Scan the bar code, [Set Code 128 Length 2 on page 196](#) below. You'll need to cover any unused bar codes on this and the facing page to ensure that the scanner reads only the bar code you intend to scan.
3. Scan the appropriate digits from the [Alpha–Numeric Keypad in Appendix C](#) that represent the desired label length. The selectable range for this option is 01 to 80. Pad all single digit numbers with a leading zero to yield a two–digit entry (01–80).
4. Complete the programming sequence by scanning the ENTER/EXIT Programming Mode bar code.



Set Code 128 Length 2

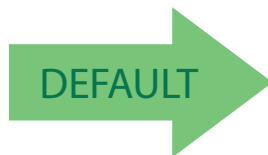

Default setting for this feature = 50 (length = 80)

Code 128 Stitching

Enables/disables stitching for Code 128 labels. When parts of a Code 128 bar code are presented to the scanner with this feature enabled, the bar code parts will be assembled by the scanner's software, and the data will be decoded if all bar code proofing requirements are met.

To set this feature:

1. Scan the ENTER/EXIT Programming Mode bar code.
2. Scan your selection from the bar codes below. You'll need to cover any unused bar codes on this and the facing page to ensure that the scanner reads only the bar code you intend to scan.
3. Complete the programming sequence by scanning the ENTER/EXIT Programming Mode bar code.



Code 128 Stitching = Disable



Code 128 Stitche = Enable



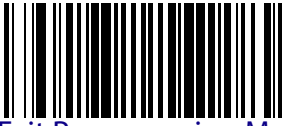

EAN-128

EAN-128 Enable

Enables/disables the ability of the scanner to translate EAN128 labels to the EAN128 data format.

To set this feature:

1. Scan the ENTER/EXIT Programming Mode bar code.
2. Scan either the enable or disable bar code below. You'll need to cover any unused bar codes on this and the facing page to ensure that the scanner reads only the bar code you intend to scan.
3. Complete the programming sequence by scanning the ENTER/EXIT Programming Mode bar code.

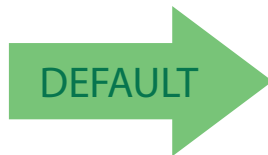

EAN-128 = Transmit EAN128 labels in Code128 data format



EAN-128 = Transmit EAN128 labels in EAN128 data format

Interleaved 2 of 5 (I 2 OF 5)

Interleaved 2 of 5 (I 2 OF 5) Enable

Enables/disables the ability of the scanner to decode Interleaved 2 of 5 labels.
To set this feature:

1. Scan the ENTER/EXIT Programming Mode bar code.
2. Scan either the enable or disable bar code below. You'll need to cover any unused bar codes on this and the facing page to ensure that the scanner reads only the bar code you intend to scan.
3. Complete the programming sequence by scanning the ENTER/EXIT Programming Mode bar code.

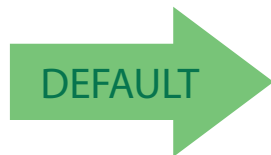

I 2 of 5 = Disable



I 2 of 5 = Enable



I 2 of 5 Check Character Calculation

Enables/disables calculation and verification of an optional Interleaved 2 of 5 check character.



NOTE

If check character calculation is disabled, the risk is increased that a misread can occur. When disabled, any check characters in a bar code are treated as data characters.

1. To set this feature:
2. Scan the ENTER/EXIT Programming Mode bar code.
3. Scan either the enable or disable bar code below. You'll need to cover any unused bar codes on this and the facing page to ensure that the scanner reads only the bar code you intend to scan.
4. Complete the programming sequence by scanning the ENTER/EXIT Programming Mode bar code.

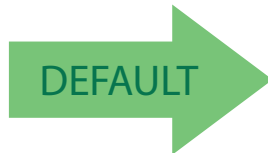

I 2 of 5 Check Character Calculation = Disable



I 2 of 5 Check Character Calculation = Enable

I 2 of 5 Check Character Transmission

Enables/disables transmission of an optional Interleaved 2 of 5 check character.



NOTE

This feature applies only when I 2 of 5 Check Character Calculation is enabled. This item is ignored when the advanced feature, Full Label Edit, is enabled.

To set this feature:

1. Scan the ENTER/EXIT Programming Mode bar code.
2. Scan either the enable or disable bar code below. You'll need to cover any unused bar codes on this and the facing page to ensure that the scanner reads only the bar code you intend to scan.
3. Complete the programming sequence by scanning the ENTER/EXIT Programming Mode bar code.



I 2 of 5 Check Character Transmission = Disable



I 2 of 5 Check Character Transmission = Enable





I 2 of 5 Minimum Read

This feature specifies the minimum number of consecutive I 2 of 5 decodes before is accepted as good read.

To set this feature:

1. Scan the ENTER/EXIT Programming Mode bar code.
2. Scan your selection from the bar codes below. You'll need to cover any unused bar codes on this and the facing page to ensure that the scanner reads only the bar code you intend to scan.
3. Complete the programming sequence by scanning the ENTER/EXIT Programming Mode bar code.

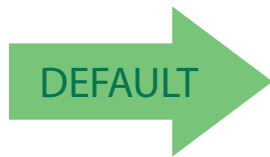

I 2 of 5 Minimum Read = 1



I 2 of 5 Minimum Read = 2



I 2 of 5 Minimum Read = 3



I 2 of 5 Minimum Read = 4

I 2 of 5 Correlation

Enables/disables character correlation for I 2 of 5.

To set this feature:

1. Scan the ENTER/EXIT Programming Mode bar code.
2. Scan either the enable or disable bar code below. You'll need to cover any unused bar codes on this and the facing page to ensure that the scanner reads only the bar code you intend to scan.
3. Complete the programming sequence by scanning the ENTER/EXIT Programming Mode bar code.

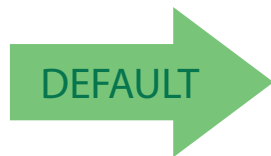

I 2 of 5 Correlation = Disable



I 2 of 5 Correlation = Enable

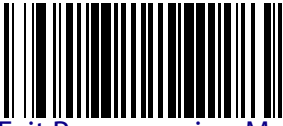

I 2 of 5 Length Control

This feature specifies whether variable-length or fixed-length decoding will be set for I 2 of 5.

To set this feature:

1. Scan the ENTER/EXIT Programming Mode bar code.
2. Scan your selection from the bar codes below. You'll need to cover any unused bar codes on this and the facing page to ensure that the scanner reads only the bar code you intend to scan.
3. Complete the programming sequence by scanning the ENTER/EXIT Programming Mode bar code.

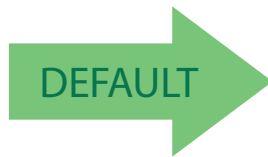

I 2 of 5 Length Control = Variable Length



I 2 of 5 Length Control = Fixed Length

I 2 of 5 Length 1

If I 2 of 5 Length Control is set to Fixed–Length decoding, this feature specifies I 2 of 5 first fixed length. If I 2 of 5 Length Control is set to Variable–Length decoding, this feature specifies the minimum label length.

To set this feature:

1. Scan the ENTER/EXIT Programming Mode bar code.
2. Scan the bar code, [Set I 2 of 5 Length 1 on page 205](#) below. You'll need to cover any unused bar codes on this and the facing page to ensure that the scanner reads only the bar code you intend to scan.
3. Scan the appropriate digits from the [Alpha–Numeric Keypad in Appendix C](#) that represent the desired label length. The selectable range for this option is 02 to 50, even numbers only. Pad all single digit numbers with a leading zero to yield a two–digit entry (02–50).
4. Complete the programming sequence by scanning the ENTER/EXIT Programming Mode bar code.



Set I 2 of 5 Length 1

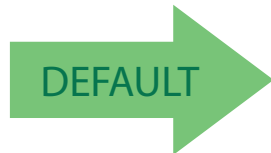

Default setting for this feature = Length 06



I 2 of 5 Length 2

If I 2 of 5 Length Control is set to Fixed–Length decoding, this feature specifies I 2 of 5 second fixed length. If I 2 of 5 Length Control is set to Variable–Length decoding, this feature specifies the maximum label length.



NOTE

When in Fixed Length mode, if Length 2 is set to the value of 00 (zero), then only Length 1 will apply.

To set this feature:

1. Scan the ENTER/EXIT Programming Mode bar code.
2. Scan the bar code, [Set I 2 of 5 Length 2 on page 206](#) below. You’ll need to cover any unused bar codes on this and the facing page to ensure that the scanner reads only the bar code you intend to scan.
3. Scan the appropriate digits from the [Alpha–Numeric Keypad in Appendix C](#) that represent the desired label length. The selectable range for this option is 00, or 02 to 50; even numbers only. Pad all single digit numbers with a leading zero to yield a two–digit entry (02–50).
4. Complete the programming sequence by scanning the ENTER/EXIT Programming Mode bar code.



Set I 2 of 5 Length 2

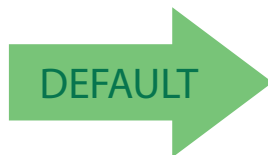

Default setting for this feature = 32 (length = 50)

I 2 of 5 Stitching

Enables/disables stitching for I 2 of 5 labels. When parts of an I 2 of 5 bar code are presented to the scanner with this feature enabled, the bar code parts will be assembled by the scanner's software, and the data will be decoded if all bar code proofing requirements are met.

To set this feature:

1. Scan the ENTER/EXIT Programming Mode bar code.
2. Scan your selection from the bar codes below. You'll need to cover any unused bar codes on this and the facing page to ensure that the scanner reads only the bar code you intend to scan.
3. Complete the programming sequence by scanning the ENTER/EXIT Programming Mode bar code.

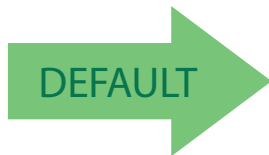

I 2 of 5 Stitching = Disable



I 2 of 5 Stitching = Enable



Codabar

Codabar Enable

Enables/disables the ability of the scanner to decode Codabar labels.

To set this feature:

1. Scan the ENTER/EXIT Programming Mode bar code.
2. Scan either the enable or disable bar code below. You'll need to cover any unused bar codes on this and the facing page to ensure that the scanner reads only the bar code you intend to scan.
3. Complete the programming sequence by scanning the ENTER/EXIT Programming Mode bar code.

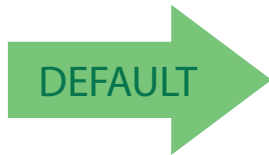

Codabar = Disable



Codabar = Enable

Codabar Start Stop Character Transmission

Enables/disables transmission of Codabar start and stop characters.



This item is ignored when the advanced feature, Full Label Edit, is enabled.

NOTE

To set this feature:

1. Scan the ENTER/EXIT Programming Mode bar code.
2. Scan either the enable or disable bar code below. You'll need to cover any unused bar codes on this and the facing page to ensure that the scanner reads only the bar code you intend to scan.
3. Complete the programming sequence by scanning the ENTER/EXIT Programming Mode bar code.



Codabar Start Stop Character Transmission = Disable



Codabar Start Stop Character Transmission = Enable



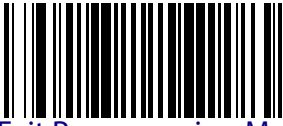

Codabar Start Stop Character Set

This feature specifies the format of transmitted Codabar start/stop characters.

Options are:

- ABCD/TN* E
- ABCD/ABCD
- abcd/tn* e
- abcd/abcd

To set this feature:

1. Scan the ENTER/EXIT Programming Mode bar code.
2. Scan the bar code below or from the following page representing the desired option. You'll need to cover any unused bar codes and facing pages to ensure that the scanner reads only the bar code you intend to scan.
3. Complete the programming sequence by scanning the ENTER/EXIT Programming Mode bar code.



Codabar Start Stop Character Set = ABCD/TN* E



Codabar Start Stop Character Set = ABCD/ABCD



Codabar Start Stop Character Set = abcd/tn* e



Codabar Start Stop Character Set = abcd/abcd



Codabar Start Stop Character Match

Enables/disables the requirement that Codabar start and stop characters match.

To set this feature:

1. Scan the ENTER/EXIT Programming Mode bar code.
2. Scan either the enable or disable bar code below. You'll need to cover any unused bar codes on this and the facing page to ensure that the scanner reads only the bar code you intend to scan.
3. Complete the programming sequence by scanning the ENTER/EXIT Programming Mode bar code.

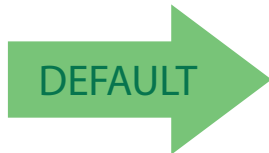

Codabar Start Stop Character Match = Disable



Codabar Start Stop Character Match = Enable

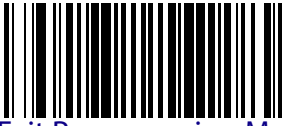

Codabar Check Character Calculation

Enables/disables calculation and verification of an optional Codabar check character.



NOTE

If check character calculation is disabled, the risk is increased that a misread can occur. When disabled, any check characters in a bar code are treated as data characters.

To set this feature:

1. Scan the ENTER/EXIT Programming Mode bar code.
2. Scan either the enable or disable bar code below. You'll need to cover any unused bar codes on this and the facing page to ensure that the scanner reads only the bar code you intend to scan.
3. Complete the programming sequence by scanning the ENTER/EXIT Programming Mode bar code.

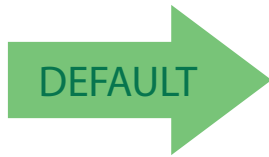

Codabar Check Character Calculation = Disable



Codabar Check Character Calculation = Enable

Codabar Check Character Transmission

Enables/disables transmission of an optional Codabar check character.



NOTE

Applies only when Codabar Check Character Calculation is enabled. This item is ignored when the advanced feature, Full Label Edit, is enabled.

To set this feature:

1. Scan the ENTER/EXIT Programming Mode bar code.
2. Scan either the enable or disable bar code below. You'll need to cover any unused bar codes on this and the facing page to ensure that the scanner reads only the bar code you intend to scan.
3. Complete the programming sequence by scanning the ENTER/EXIT Programming Mode bar code.



Codabar Check Character Transmission = Disable



Codabar Check Character Transmission = Enable



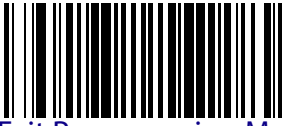

Codabar Minimum Read

This feature specifies the minimum number of consecutive Codabar decodes before is accepted as good read.

To set this feature:

1. Scan the ENTER/EXIT Programming Mode bar code.
2. Scan your selection from the bar codes below. You'll need to cover any unused bar codes on this and the facing page to ensure that the scanner reads only the bar code you intend to scan.
3. Complete the programming sequence by scanning the ENTER/EXIT Programming Mode bar code.

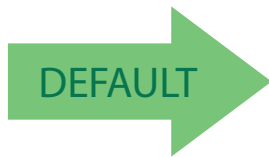

Codabar Minimum Read = 1



Codabar Minimum Read = 2



Codabar Minimum Read = 3



Codabar Minimum Read = 4

Codabar Correlation

Enables/disables character correlation for Codabar.

To set this feature:

1. Scan the ENTER/EXIT Programming Mode bar code.
2. Scan either the enable or disable bar code below. You'll need to cover any unused bar codes on this and the facing page to ensure that the scanner reads only the bar code you intend to scan.
3. Complete the programming sequence by scanning the ENTER/EXIT Programming Mode bar code.

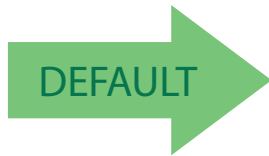

Codabar Correlation = Disable



Codabar Correlation = Enable



Codabar Length Control

This feature specifies whether variable-length or fixed-length decoding will be set for Codabar.

To set this feature:

1. Scan the ENTER/EXIT Programming Mode bar code.
2. Scan your selection from the bar codes below. You'll need to cover any unused bar codes on this and the facing page to ensure that the scanner reads only the bar code you intend to scan.
3. Complete the programming sequence by scanning the ENTER/EXIT Programming Mode bar code.

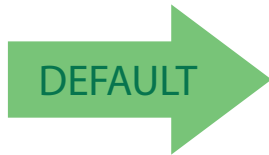

Codabar Length Control = Variable Length

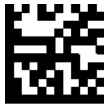

Codabar Length Control = Fixed Length

Codabar Length 1

If Codabar Length Control is set to Fixed–Length decoding, this feature specifies Codabar first fixed length. If Codabar Length Control is set to Variable–Length decoding, this feature specifies the minimum label length.

To set this feature:

1. Scan the ENTER/EXIT Programming Mode bar code.
2. Scan the bar code, [Set Codabar Length 1 on page 217](#) below. You'll need to cover any unused bar codes on this and the facing page to ensure that the scanner reads only the bar code you intend to scan.
3. Scan the appropriate digits from the [Alpha–Numeric Keypad in Appendix C](#) that represent the desired label length. The selectable range for this option is 03 to 50. Pad all single digit numbers with a leading zero to yield a two–digit entry (03–50).
4. Complete the programming sequence by scanning the ENTER/EXIT Programming Mode bar code.



Set Codabar Length 1

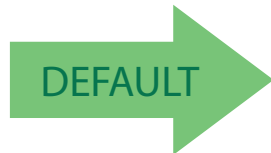

Default setting for this feature = 03



Codabar Length 2

If Codabar Length Control is set to Fixed–Length decoding, this feature specifies Codabar second fixed length. If Codabar Length Control is set to Variable–Length decoding, this feature specifies the maximum label length.



NOTE

When in Fixed Length mode, if Length 2 is set to the value of 00 (zero), then only Length 1 will apply.

To set this feature:

1. Scan the ENTER/EXIT Programming Mode bar code.
2. Scan the bar code, [Set Codabar Length 2 on page 218](#) below. You’ll need to cover any unused bar codes on this and the facing page to ensure that the scanner reads only the bar code you intend to scan.
3. Scan the appropriate digits from the [Alpha–Numeric Keypad in Appendix C](#) that represent the desired label length. The selectable range for this option is 00 (meaning ignore this length), or 03 to 50. Pad all single digit numbers with a leading zero to yield a two–digit entry (03–50).
4. Complete the programming sequence by scanning the ENTER/EXIT Programming Mode bar code.



Set Codabar Length 2

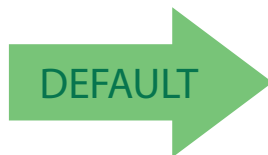

Default setting for this feature is Length = 32 (length = 50)

Codabar Stitching

Enables/disables stitching for Codabar labels. When parts of a Codabar bar code are presented to the scanner with this feature enabled, the bar code parts will be assembled by the scanner's software, and the data will be decoded if all bar code proofing requirements are met.

To set this feature:

1. Scan the ENTER/EXIT Programming Mode bar code.
2. Scan your selection from the bar codes below. You'll need to cover any unused bar codes on this and the facing page to ensure that the scanner reads only the bar code you intend to scan.
3. Complete the programming sequence by scanning the ENTER/EXIT Programming Mode bar code.

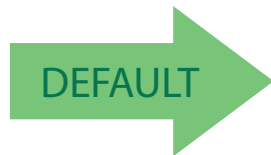

Codabar Stitching = Disable



Codabar Stitching = Enable

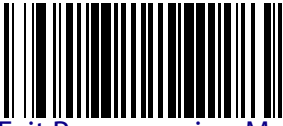

Codabar Require Margins

Enables/disables the requirement that quiet zones be present in a Codabar bar code.

To set this feature:

1. Scan the ENTER/EXIT Programming Mode bar code.
2. Scan either the enable or disable bar code below. You'll need to cover any unused bar codes on this and the facing page to ensure that the scanner reads only the bar code you intend to scan.
3. Complete the programming sequence by scanning the ENTER/EXIT Programming Mode bar code.

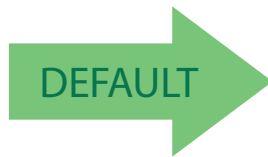

Codabar Require Margins = Quiet Zones Not Required



Codabar Require Margins = Quiet Zones Required

Code 93

Code 93 Enable

Enables/disables the ability of the scanner to decode Code 93 labels.

To set this feature:

1. Scan the ENTER/EXIT Programming Mode bar code.
2. Scan either the enable or disable bar code below. You'll need to cover any unused bar codes on this and the facing page to ensure that the scanner reads only the bar code you intend to scan.
3. Complete the programming sequence by scanning the ENTER/EXIT Programming Mode bar code.

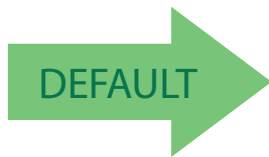

Code 93 = Disable

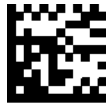

Code 93 = Enable



Code 93 Minimum Read

This feature specifies the minimum number of consecutive Code 93 decodes before is accepted as good read.

To set this feature:

1. Scan the ENTER/EXIT Programming Mode bar code.
2. Scan your selection from the bar codes below. You'll need to cover any unused bar codes on this and the facing page to ensure that the scanner reads only the bar code you intend to scan.
3. Complete the programming sequence by scanning the ENTER/EXIT Programming Mode bar code.

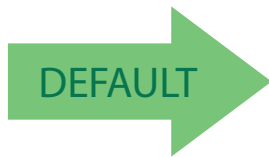

Code 93 Minimum Read = 1



Code 93 Minimum Read = 2



Code 93 Minimum Read = 3



Code 93 Minimum Read = 4

Code 93 Correlation

Enables/disables character correlation for Code 93.

To set this feature:

1. Scan the ENTER/EXIT Programming Mode bar code.
2. Scan either the enable or disable bar code below. You'll need to cover any unused bar codes on this and the facing page to ensure that the scanner reads only the bar code you intend to scan.
3. Complete the programming sequence by scanning the ENTER/EXIT Programming Mode bar code.

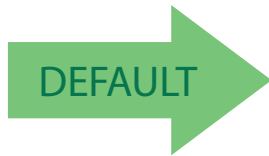

Code 93 Correlation = Disable



Code 93 Correlation = Enable



Code 93 Length Control

This feature specifies whether variable-length or fixed-length decoding will be set for Code 93.

To set this feature:

1. Scan the ENTER/EXIT Programming Mode bar code.
2. Scan your selection from the bar codes below. You'll need to cover any unused bar codes on this and the facing page to ensure that the scanner reads only the bar code you intend to scan.
3. Complete the programming sequence by scanning the ENTER/EXIT Programming Mode bar code.

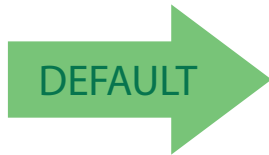

Code 93 Length Control = Variable Length

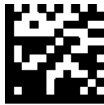

Code 93 Length Control = Fixed Length

Code 93 Length 1

If Code 93 Length Control is set to Fixed–Length decoding, this feature specifies Code 93 first fixed length. If Code 93 Length Control is set to Variable–Length decoding, this feature specifies the minimum label length.

To set this feature:

1. Scan the ENTER/EXIT Programming Mode bar code.
2. Scan the bar code, [Set Code 93 Length 1 on page 225](#) below. You'll need to cover any unused bar codes on this and the facing page to ensure that the scanner reads only the bar code you intend to scan.
3. Scan the appropriate digits from the [Alpha–Numeric Keypad in Appendix C](#) that represent the desired label length. The selectable range for this option is 01 to 50. Pad all single digit numbers with a leading zero to yield a two–digit entry (01–50).
4. Complete the programming sequence by scanning the ENTER/EXIT Programming Mode bar code.



Set Code 93 Length 1

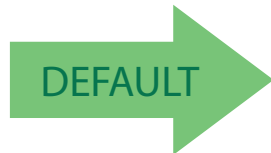

Default setting for this feature = 01



Code 93 Length 2

If Code 93 Length Control is set to Fixed–Length decoding, this feature specifies Code 93 second fixed length. If Code 93 Length Control is set to Variable–Length decoding, this feature specifies the maximum label length.



NOTE

When in Fixed Length mode, if Fixed Length 2 is set to the value of 00 (zero), then only Length 1 will apply.

To set this feature:

1. Scan the ENTER/EXIT Programming Mode bar code.
2. Scan the bar code, [Set Code 93 Length 2 on page 226](#) below. You’ll need to cover any unused bar codes on this and the facing page to ensure that the scanner reads only the bar code you intend to scan.
3. Scan the appropriate digits from the [Alpha–Numeric Keypad in Appendix C](#) that represent the desired label length. The selectable range for this option is 00 (meaning ignore this length), or 01 to 50. Pad all single digit numbers with a leading zero to yield a two–digit entry (01–50).
4. Complete the programming sequence by scanning the ENTER/EXIT Programming Mode bar code.



Set Code 93 Length 2

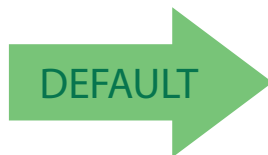

Default setting for this feature = 32 (length = 50)

Code 93 Stitching

Enables/disables stitching for Code 93 labels. When parts of a Code 93 bar code are presented to the scanner with this feature enabled, the bar code parts will be assembled by the scanner's software, and the data will be decoded if all bar code proofing requirements are met.

To set this feature:

1. Scan the ENTER/EXIT Programming Mode bar code.
2. Scan your selection from the bar codes below. You'll need to cover any unused bar codes on this and the facing page to ensure that the scanner reads only the bar code you intend to scan.
3. Complete the programming sequence by scanning the ENTER/EXIT Programming Mode bar code.



Code 93 Stitching = Disable



Code 93 Stitching = Enable





MSI

MSI Enable

Enables/disables the ability of the scanner to decode MSI labels.

To set this feature:

1. Scan the ENTER/EXIT Programming Mode bar code.
2. Scan either the enable or disable bar code below. You'll need to cover any unused bar codes on this and the facing page to ensure that the scanner reads only the bar code you intend to scan.
3. Complete the programming sequence by scanning the ENTER/EXIT Programming Mode bar code.

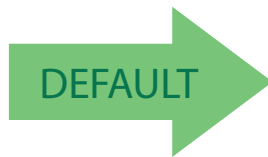

MSI = Disable



MSI = Enable

MSI Check Character Calculation

Enables/disables calculation and verification of optional MSI check characters.



NOTE

If check character calculation is disabled, the risk is increased that a misread can occur. When disabled, any check characters in a bar code are treated as data characters.

To set this feature:

1. Scan the ENTER/EXIT Programming Mode bar code.
2. Scan either the enable or disable bar code below. You'll need to cover any unused bar codes on this and the facing page to ensure that the scanner reads only the bar code you intend to scan.
3. Complete the programming sequence by scanning the ENTER/EXIT Programming Mode bar code.



MSI Check Character Calculation = Disable



MSI Check Character Calculation = Enable



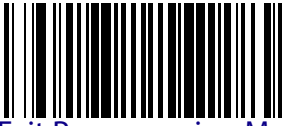

MSI Number of Check Characters

Specifies number of MSI check characters to be calculated and verified.



Check characters are always modulus 10.

NOTE

To set this feature:

1. Scan the ENTER/EXIT Programming Mode bar code.
2. Scan the bar code below representing the desired number of MSI check characters to be calculated and verified. You'll need to cover any unused bar codes on this and the facing page to ensure that the scanner reads only the bar code you intend to scan.
3. Complete the programming sequence by scanning the ENTER/EXIT Programming Mode bar code.

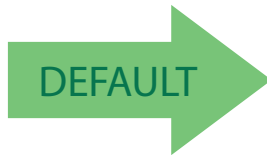

MSI Number of Check Characters = 1

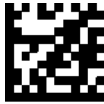

MSI Number of Check Characters = 2

MSI Check Character Transmission

Enables/disables transmission of optional MSI check characters.



NOTE

This feature applies only when MSI Check Character Calculation on page 229 is enabled. This item is ignored when the advanced feature, Full Label Edit, is enabled.

To set this feature:

1. Scan the ENTER/EXIT Programming Mode bar code.
2. Scan either the enable or disable bar code below. You'll need to cover any unused bar codes on this and the facing page to ensure that the scanner reads only the bar code you intend to scan.
3. Complete the programming sequence by scanning the ENTER/EXIT Programming Mode bar code.



MSI Check Character Transmission = Disable



MSI Check Character Transmission = Enable





MSI Minimum Read

This feature specifies the minimum number of consecutive MSI decodes before is accepted as good read.

To set this feature:

1. Scan the ENTER/EXIT Programming Mode bar code.
2. Scan your selection from the bar codes below. You'll need to cover any unused bar codes on this and the facing page to ensure that the scanner reads only the bar code you intend to scan.
3. Complete the programming sequence by scanning the ENTER/EXIT Programming Mode bar code.

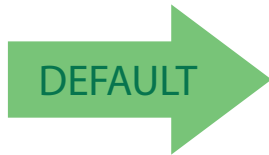

MSI Minimum Read = 1



MSI Minimum Read = 2



MSI Minimum Read = 3



MSI Minimum Read = 4

MSI Correlation

Enables/disables character correlation for MSI.

To set this feature:

1. Scan the ENTER/EXIT Programming Mode bar code.
2. Scan either the enable or disable bar code below. You'll need to cover any unused bar codes on this and the facing page to ensure that the scanner reads only the bar code you intend to scan.
3. Complete the programming sequence by scanning the ENTER/EXIT Programming Mode bar code.

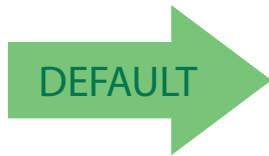

MSI Correlation = Disable



MSI Correlation = Enable

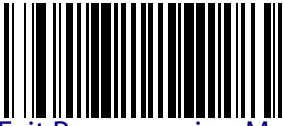

MSI Length Control

This feature specifies whether variable-length or fixed-length decoding will be set for MSI.

To set this feature:

1. Scan the ENTER/EXIT Programming Mode bar code.
2. Scan your selection from the bar codes below. You'll need to cover any unused bar codes on this and the facing page to ensure that the scanner reads only the bar code you intend to scan.
3. Complete the programming sequence by scanning the ENTER/EXIT Programming Mode bar code.

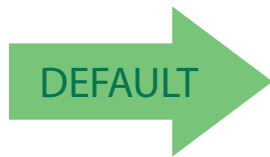

MSI Length Control = Variable Length



MSI Length Control = Fixed Length

MSI Length 1

If MSI Length Control is set to Fixed–Length decoding, this feature specifies MSI first fixed length. If MSI Length Control is set to Variable–Length decoding, this feature specifies the minimum label length.

To set this feature:

1. Scan the ENTER/EXIT Programming Mode bar code.
2. Scan the bar code, [Set MSI Length 1 on page 235](#) below. You’ll need to cover any unused bar codes on this and the facing page to ensure that the scanner reads only the bar code you intend to scan.
3. Scan the appropriate digits from the [Alpha–Numeric Keypad in Appendix C](#) that represent the desired label length. The selectable range for this option is 4 to 16. Pad all single digit numbers with a leading zero to yield a two–digit entry (04–16).
4. Complete the programming sequence by scanning the ENTER/EXIT Programming Mode bar code.



Set MSI Length 1

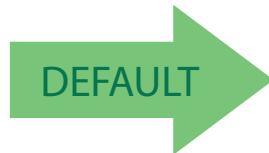

Default setting for this feature = 04

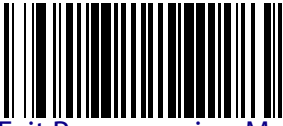

MSI Length 2

If MSI Length Control is set to Fixed–Length decoding, this feature specifies MSI second fixed length. If MSI Length Control is set to Variable–Length decoding, this feature specifies the maximum label length.



When in Fixed Length mode, if Length 2 is set to the value 00 (zero), then only Length 1 will apply.

NOTE

To set this feature:

1. Scan the ENTER/EXIT Programming Mode bar code.
2. Scan the bar code, [Set MSI Length 2 on page 236](#) below. You'll need to cover any unused bar codes on this and the facing page to ensure that the scanner reads only the bar code you intend to scan.
3. Scan the appropriate digits from the [Alpha–Numeric Keypad in Appendix C](#) that represent the desired label length. The selectable range for this option is 00 (meaning ignore this length), or 04 to 16. Pad all single digit numbers with a leading zero to yield a two–digit entry (00, 04–16).
4. Complete the programming sequence by scanning the ENTER/EXIT Programming Mode bar code.



Set MSI Length 2

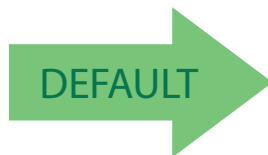

Default setting for this feature = 10 (length = 16)

MSI Stitching

Enables/disables stitching for MSI labels. When parts of an MSI bar code are presented to the scanner with this feature enabled, the bar code parts will be assembled by the scanner's software, and the data will be decoded if all bar code proofing requirements are met.

To set this feature:

1. Scan the ENTER/EXIT Programming Mode bar code.
2. Scan your selection from the bar codes below. You'll need to cover any unused bar codes on this and the facing page to ensure that the scanner reads only the bar code you intend to scan.
3. Complete the programming sequence by scanning the ENTER/EXIT Programming Mode bar code.

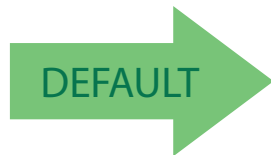

MSI Stitching = Disable



MSI Stitching = Enable



Standard 2 of 5

Standard 2 of 5 Enable

Enables/disables the ability of the scanner to decode Standard 2 of 5 labels.
To set this feature:

1. Scan the ENTER/EXIT Programming Mode bar code.
2. Scan either the enable or disable bar code below. You'll need to cover any unused bar codes on this and the facing page to ensure that the scanner reads only the bar code you intend to scan.
3. Complete the programming sequence by scanning the ENTER/EXIT Programming Mode bar code.

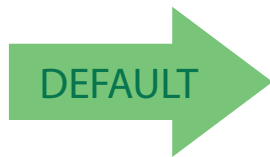

Standard 2 of 5 = Disable



Standard 2 of 5 = Enable

Standard 2 of 5 Check Character Calculation

Enables/disables calculation and verification of an optional Standard 2 of 5 check character.



NOTE

If check character calculation is disabled, the risk is increased that a misread can occur. When disabled, any check character in a bar code is treated as data character.

To set this feature:

1. Scan the ENTER/EXIT Programming Mode bar code.
2. Scan either the enable or disable bar code below. You'll need to cover any unused bar codes on this and the facing page to ensure that the scanner reads only the bar code you intend to scan.
3. Complete the programming sequence by scanning the ENTER/EXIT Programming Mode bar code.

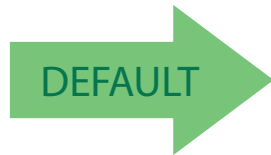

Standard 2 of 5 Check Character Calculation = Disable



Standard 2 of 5 Check Character Calculation = Enable

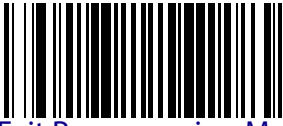

Standard 2 of 5 Check Character Transmission

Enables/disables transmission of an optional Standard 2 of 5 check character.



NOTE

This feature applies only when Standard 2 of 5 Check Character Calculation on page 239 is enabled. This item is ignored when the advanced feature, Full Label Edit, is enabled.

To set this feature:

1. Scan the ENTER/EXIT Programming Mode bar code.
2. Scan either the enable or disable bar code below. You'll need to cover any unused bar codes on this and the facing page to ensure that the scanner reads only the bar code you intend to scan.
3. Complete the programming sequence by scanning the ENTER/EXIT Programming Mode bar code.



Standard 2 of 5 Check Character Transmission = Disable



Standard 2 of 5 Check Character Transmission = Enable



Standard 2 of 5 Minimum Read

This feature specifies the minimum number of consecutive Standard 2 of 5 decodes before is accepted as good read.

To set this feature:

1. Scan the ENTER/EXIT Programming Mode bar code.
2. Scan your selection from the bar codes below. You'll need to cover any unused bar codes on this and the facing page to ensure that the scanner reads only the bar code you intend to scan.
3. Complete the programming sequence by scanning the ENTER/EXIT Programming Mode bar code.

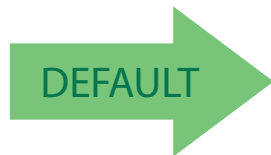

Standard 2 of 5 Minimum Read = 1



Standard 2 of 5 Minimum Read = 2



Standard 2 of 5 Minimum Read = 3



Standard 2 of 5 Minimum Read = 4

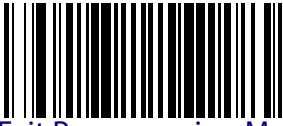

Standard 2 of 5 Correlation

Enables/disables character correlation for Standard 2 of 5.

To set this feature:

1. Scan the ENTER/EXIT Programming Mode bar code.
2. Scan either the enable or disable bar code below. You'll need to cover any unused bar codes on this and the facing page to ensure that the scanner reads only the bar code you intend to scan.
3. Complete the programming sequence by scanning the ENTER/EXIT Programming Mode bar code.

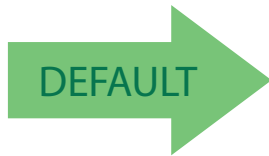

Standard 2 of 5 Correlation = Disable



Standard 2 of 5 Correlation = Enable



Standard 2 of 5 Length Control

This feature specifies whether variable-length or fixed-length decoding will be set for Standard 2 of 5.

To set this feature:

1. Scan the ENTER/EXIT Programming Mode bar code.
2. Scan your selection from the bar codes below. You'll need to cover any unused bar codes on this and the facing page to ensure that the scanner reads only the bar code you intend to scan.
3. Complete the programming sequence by scanning the ENTER/EXIT Programming Mode bar code.

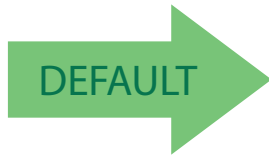

Standard 2 of 5 Length Control = Variable Length

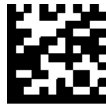

Standard 2 of 5 Length Control = Fixed Length



Standard 2 of 5 Length 1

If Standard 2 of 5 Length Control is set to Fixed–Length decoding, this feature specifies Standard 2 of 5 first fixed length. If Standard 2 of 5 Length Control is set to Variable–Length decoding, this feature specifies the minimum label length.

To set this feature:

1. Scan the ENTER/EXIT Programming Mode bar code.
2. Scan the bar code, [Set Standard 2 of 5 Length 1 on page 244](#) below. You'll need to cover any unused bar codes on this and the facing page to ensure that the scanner reads only the bar code you intend to scan.
3. Scan the appropriate digits from the [Alpha–Numeric Keypad in Appendix C](#) that represent the desired label length. The selectable range for this option is 1 to 50. Pad all single digit numbers with a leading zero to yield a two–digit entry (01–50).
4. Complete the programming sequence by scanning the ENTER/EXIT Programming Mode bar code.



Set Standard 2 of 5 Length 1

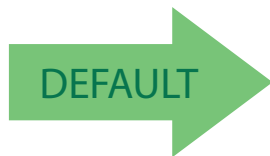

Default setting for this feature = 08

Standard 2 of 5 Length 2

If Standard 2 of 5 Length Control is set to Fixed–Length decoding, this feature specifies Standard 2 of 5 second fixed length. If Standard 2 of 5 Length Control is set to Variable–Length decoding, this feature specifies the maximum label length.



NOTE

When in Fixed Length mode, if Length 2 is set to the value of 00 (zero), then only Length 1 will apply.

To set this feature:

1. Scan the ENTER/EXIT Programming Mode bar code.
2. Scan the bar code, [Set Standard 2 of 5 Length 2 on page 245](#) below. You'll need to cover any unused bar codes on this and the facing page to ensure that the scanner reads only the bar code you intend to scan.
3. Scan the appropriate digits from the [Alpha–Numeric Keypad in Appendix C](#) that represent the desired label length. The selectable range for this option is 1 to 50. Pad all single digit numbers with a leading zero to yield a two–digit entry (01–50).
4. Complete the programming sequence by scanning the ENTER/EXIT Programming Mode bar code.



Set Standard 2 of 5 Length 2

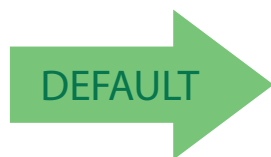

Default setting for this feature = 32 (length = 50)

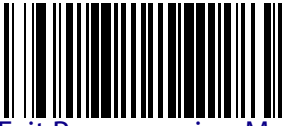

Standard 2 of 5 Stitching

Enables/disables stitching for Standard 2 of 5 labels. When parts of a Standard 2 of 5 bar code are presented to the scanner with this feature enabled, the bar code parts will be assembled by the scanner's software, and the data will be decoded if all bar code proofing requirements are met.



This applies when Standard 2 of 5 Length Control on page 243 is set to fixed-length decoding.

NOTE

To set this feature:

1. Scan the ENTER/EXIT Programming Mode bar code.
2. Scan your selection from the bar codes below. You'll need to cover any unused bar codes on this and the facing page to ensure that the scanner reads only the bar code you intend to scan.
3. Complete the programming sequence by scanning the ENTER/EXIT Programming Mode bar code.

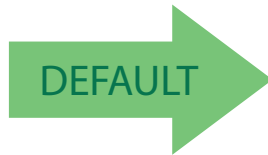

Standard 2 of 5 Stitching = Disable



Standard 2 of 5 Stitching = Enable



2D Symbologies/Bar Codes

2D Codes



NOTE

If the scanner's interface type must be changed, always be sure that interface configuration is the **FIRST** item scanned during a programming session. (Selecting an interface type resets **ALL** other configuration items — including symbology programming — to the factory default for that interface type.)

The following pages contain configuration information concerning the various 2D bar code types the scanner supports.

DATA MATRIX starting on page 248
PDF 417 starting on page 252
MICRO PDF 417 starting on page 256
QR CODE starting on page 260
MICRO QR CODE starting on page 265
AZTEC CODE starting on page 268



Data Matrix

Data Matrix Enable

Enables/disables the ability of the scanner to decode Data Matrix labels.

To set this feature:

1. Scan the Enter/Exit Programming Mode bar code.
2. Scan either the enable or disable bar code below. You'll need to cover any unused bar codes on this and the facing page to ensure that the scanner reads only the bar code you intend to scan.
3. Complete the programming sequence by scanning the Enter/Exit Programming Mode bar code.

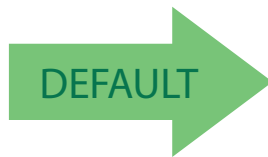

Data Matrix = Disable



Data Matrix = Enable

Data Matrix Length Control

Fixed Length Decoding — When fixed length decoding is enabled, the scanner will decode a bar code if the label length matches one of the configurable fixed lengths.

Variable Length Decoding — When variable length decoding is enabled, the scanner will decode a bar code if the label length falls in the range of the configurable minimum and maximum length.

Configuring Fixed Length Decoding:

1. Scan the ENTER/EXIT Programming Mode bar code.
2. Scan the Fixed Length Decoding bar code.
3. Scan the ENTER/EXIT Programming Mode bar code.
4. Set Length 1 to the first fixed length using the [Data Matrix Length 1, Length 2 Programming Instructions on page 250](#) that follow this page.
5. Set Length 2 to the second fixed length (or to '0000' if there is only one fixed length) using the [Data Matrix Length 1, Length 2 Programming Instructions on page 250](#).

Configuring Variable Length Decoding:

1. Scan the ENTER/EXIT Programming Mode bar code.
2. Scan the Variable Length Decoding bar code.
3. Scan the ENTER/EXIT Programming Mode bar code.
4. Set Length 1 to the minimum length using the [Data Matrix Length 1, Length 2 Programming Instructions on page 250](#) that follow this page.
5. Set Length 2 to the maximum length using the [Data Matrix Length 1, Length 2 Programming Instructions on page 250](#).



Data Matrix Length Control = Variable Length



Data Matrix Length Control = Fixed Length



Data Matrix Length 1, Length 2 Programming Instructions

If Data Matrix Length Control is set to Fixed–Length decoding, this feature specifies Data Matrix first fixed length. If Data Matrix Length Control is set to Variable–Length decoding, this feature specifies the minimum label length.



For Data Matrix bar codes, only the data characters are included in the length calculations.

NOTE

To set this feature:

1. Scan the ENTER/EXIT Programming Mode bar code.
2. Scan the bar code, [Set Data Matrix Length 1 on page 250](#) or [Set Data Matrix Length 2 on page 250](#) below. You'll need to cover any unused bar codes on this and the facing page to ensure that the scanner reads only the bar code you intend to scan.
3. Scan the appropriate digits from the [Alpha–Numeric Keypad in Appendix C](#) that represent the desired label length. The selectable range for this option is 0001 to 3116. Pad all numbers with leading zeros to yield a four–digit entry (0001–3116).
4. Complete the programming sequence by scanning the ENTER/EXIT Programming Mode bar code.



Set Data Matrix Length 1
Default setting for this feature = 0001



Set Data Matrix Length 2
Default setting for this feature = 0320 (length = 800)

GS1 Datamatrix Enable

Enables/disables the ability of the scanner to decode GS1 Datamatrix labels.

To set this feature:

1. Scan the Enter/Exit Programming Mode bar code.
2. Scan either the enable or disable bar code below. You'll need to cover any unused bar codes on this and the facing page to ensure that the scanner reads only the bar code you intend to scan.
3. Complete the programming sequence by scanning the Enter/Exit Programming Mode bar code.

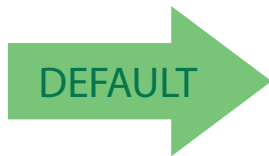

GS1 Datamatrix disabled



GS1 Datamatrix enabled

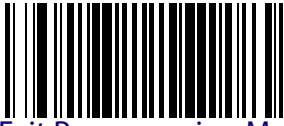

PDF 417

PDF 417 Enable

Enables the processing of PDF417 labels.

To set this feature:

1. Scan the Enter/Exit Programming Mode bar code.
2. Scan either the enable or disable bar code below. You'll need to cover any unused bar codes on this and the facing page to ensure that the scanner reads only the bar code you intend to scan.
3. Complete the programming sequence by scanning the Enter/Exit Programming Mode bar code.

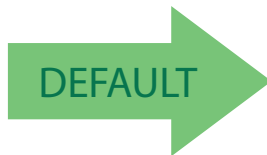

PDF 417 = Disable



PDF 417 = Enable

PDF 417 Length Control

Fixed Length Decoding — When fixed length decoding is enabled, the scanner will decode a bar code if the label length matches one of the configurable fixed lengths.

Variable Length Decoding — When variable length decoding is enabled, the scanner will decode a bar code if the label length falls in the range of the configurable minimum and maximum length.

Configuring Fixed Length Decoding:

1. Scan the ENTER/EXIT Programming Mode bar code.
2. Scan the Fixed Length Decoding bar code.
3. Scan the ENTER/EXIT Programming Mode bar code.
4. Set Length 1 to the first fixed length using the [PDF 417 Length 1, Length 2 Programming Instructions on page 254](#) that follow this page.
5. Set Length 2 to the second fixed length (or to '0000' if there is only one fixed length) using the [PDF 417 Length 1, Length 2 Programming Instructions on page 254](#).

Configuring Variable Length Decoding:

1. Scan the ENTER/EXIT Programming Mode bar code.
2. Scan the Variable Length Decoding bar code.
3. Scan the ENTER/EXIT Programming Mode bar code.
4. Set Length 1 to the minimum length using the [PDF 417 Length 1, Length 2 Programming Instructions on page 254](#) that follow this page.
5. Set Length 2 to the maximum length using the [PDF 417 Length 1, Length 2 Programming Instructions on page 254](#).

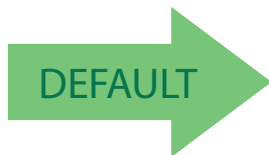

PDF 417 Length Control = Variable Length



PDF 417 Length Control = Fixed Length



PDF 417 Length 1, Length 2 Programming Instructions

If PDF417 Length Control is set to Fixed–Length decoding, this feature specifies PDF417 first fixed length. If PDF417 Length Control is set to Variable–Length decoding, this feature specifies the minimum label length.



NOTE

This tag is only valid for units with a model id that supports PDF.

Length 1 is the minimum label length if in variable length mode, or the first fixed length if in fixed length mode. Length 2 is the maximum label length if in variable length mode, or the second fixed length if in fixed length mode. Length includes the bar code's data characters only. Any value > 2710 will be considered to be 2710.

To set this feature:

1. Scan the ENTER/EXIT Programming Mode bar code.
2. Scan the bar code, [Set PDF 417 Length 1 on page 254](#) or [Set PDF 417 Length 2 on page 254](#) below. You'll need to cover any unused bar codes on this and the facing page to ensure that the scanner reads only the bar code you intend to scan.
3. Scan the appropriate digits from the [Alpha–Numeric Keypad in Appendix C](#) that represent the desired label length. The selectable range for this option is 0001 to 2710. Pad all numbers with leading zeros to yield a four–digit entry (0001–2710).
4. Complete the programming sequence by scanning the ENTER/EXIT Programming Mode bar code.



Set PDF 417 Length 1
Default setting for this feature = 0001



Set PDF 417 Length 2
Default setting for this feature = 0A96 (length = 2710)

PDF 417 Read Option

This feature specifies an additional read control option for PDF 417 bar codes. To set this feature:

1. Scan the Enter/Exit Programming Mode bar code.
2. Scan either the enable or disable bar code below. You'll need to cover any unused bar codes on this and the facing page to ensure that the scanner reads only the bar code you intend to scan.
3. Complete the programming sequence by scanning the Enter/Exit Programming Mode bar code.

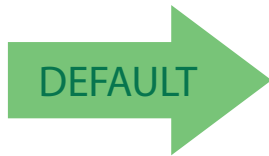

PDF 417 Read Option = None



PDF 417 Read Option = Turn Off Codeword
Length Checking



Micro PDF 417

Micro PDF 417 Enable

Enables/disables the ability of the scanner to decode Micro PDF 417 labels.
To set this feature:

1. Scan the Enter/Exit Programming Mode bar code.
2. Scan either the enable or disable bar code below. You'll need to cover any unused bar codes on this and the facing page to ensure that the scanner reads only the bar code you intend to scan.
3. Complete the programming sequence by scanning the Enter/Exit Programming Mode bar code.

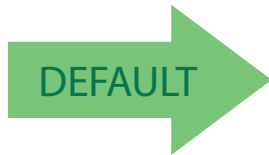

Micro PDF 417 = Disable



Micro PDF 417 = Enable

Micro PDF 417 Length Control

Fixed Length Decoding — When fixed length decoding is enabled, the scanner will decode a bar code if the label length matches one of the configurable fixed lengths.

Variable Length Decoding — When variable length decoding is enabled, the scanner will decode a bar code if the label length falls in the range of the configurable minimum and maximum length.

Configuring Fixed Length Decoding:

1. Scan the ENTER/EXIT Programming Mode bar code.
2. Scan the Fixed Length Decoding bar code.
3. Scan the ENTER/EXIT Programming Mode bar code.
4. Set Length 1 to the first fixed length using the [Micro PDF 417 Length 1, Length 2 Programming Instructions on page 258](#) that follow this page.
5. Set Length 2 to the second fixed length (or to '0000' if there is only one fixed length) using the [Micro PDF 417 Length 1, Length 2 Programming Instructions on page 258](#).

Configuring Variable Length Decoding:

1. Scan the ENTER/EXIT Programming Mode bar code.
2. Scan the Variable Length Decoding bar code.
3. Scan the ENTER/EXIT Programming Mode bar code.
4. Set Length 1 to the minimum length using the [Micro PDF 417 Length 1, Length 2 Programming Instructions on page 258](#) that follow this page.
5. Set Length 2 to the maximum length using the [Micro PDF 417 Length 1, Length 2 Programming Instructions on page 258](#).

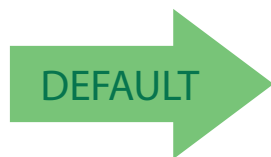

Micro PDF 417 Length Control = Variable Length



Micro PDF 417 Length Control = Fixed Length



Micro PDF 417 Length 1, Length 2 Programming Instructions

If Micro PDF 417 Length Control is set to Fixed–Length decoding, this feature specifies Micro PDF 417 first fixed length. If Micro PDF 417 Length Control is set to Variable–Length decoding, this feature specifies the minimum label length.



NOTE

This tag is only valid for units with a model ID that supports PDF.

Length 1 is the minimum label length if in variable length mode, or the first fixed length if in fixed length mode. Length 2 is the maximum label length if in variable length mode, or the second fixed length if in fixed length mode. Length includes the bar code's data characters only. Any value > 0366 will be considered to be 0366.

To set this feature:

1. Scan the ENTER/EXIT Programming Mode bar code.
2. Scan the bar code, [Set Micro PDF 417 Length 1 on page 258](#) or [Set Micro PDF 417 Length 2 on page 258](#) below. You'll need to cover any unused bar codes on this and the facing page to ensure that the scanner reads only the bar code you intend to scan.
3. Scan the appropriate digits from the [Alpha–Numeric Keypad in Appendix C](#) that represent the desired label length. The selectable range for this option is 0001 to 0366. Pad all numbers with leading zeros to yield a four–digit entry (0001–0366).
4. Complete the programming sequence by scanning the ENTER/EXIT Programming Mode bar code.



Set Micro PDF 417 Length 1
Default setting for this feature = 0001



Set Micro PDF 417 Length 2
Default setting for this feature = 016E (length = 366)

Micro PDF 417 128 Emulation

This feature specifies which AIM ID to use for Micro PDF 417 labels when performing Code 128 or EAN 128 emulation.

To set this feature:

1. Scan the Enter/Exit Programming Mode bar code.
2. Scan the bar code below for the desired setting. You'll need to cover any unused bar codes on this and the facing page to ensure that the scanner reads only the bar code you intend to scan.
3. Complete the programming sequence by scanning the Enter/Exit Programming Mode bar code.

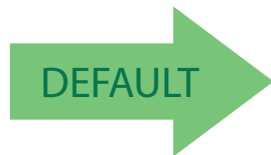

Micro PDF 417 128 Emulation = Micro PDF AIM ID and label type when emulating EAN128 or Code 128



Micro PDF 417 128 Emulation = Code 128 / EAN128 AIM ID and label type when emulating EAN128 or Code 128



QR Code

QR Code Enable

Enables/disables the ability of the scanner to decode QR Code labels.

To set this feature:

1. Scan the Enter/Exit Programming Mode bar code.
2. Scan either the enable or disable bar code below. You'll need to cover any unused bar codes on this and the facing page to ensure that the scanner reads only the bar code you intend to scan.
3. Complete the programming sequence by scanning the Enter/Exit Programming Mode bar code.

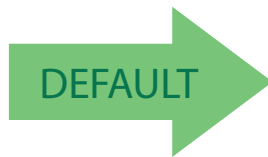

QR Code = Disable



QR Code = Enable

QR Code Length Control

Fixed Length Decoding — When fixed length decoding is enabled, the scanner will decode a bar code if the label length matches one of the configurable fixed lengths.

Variable Length Decoding — When variable length decoding is enabled, the scanner will decode a bar code if the label length falls in the range of the configurable minimum and maximum length.

Configuring Fixed Length Decoding:

1. Scan the ENTER/EXIT Programming Mode bar code.
2. Scan the Fixed Length Decoding bar code.
3. Scan the ENTER/EXIT Programming Mode bar code.
4. Set Length 1 to the first fixed length using the [QR Code Length 1, Length 2 Programming Instructions on page 262](#) that follow this page.
5. Set Length 2 to the second fixed length (or to '0000' if there is only one fixed length) using the [QR Code Length 1, Length 2 Programming Instructions on page 262](#).

Configuring Variable Length Decoding:

1. Scan the ENTER/EXIT Programming Mode bar code.
2. Scan the Variable Length Decoding bar code.
3. Scan the ENTER/EXIT Programming Mode bar code.
4. Set Length 1 to the minimum length using the [QR Code Length 1, Length 2 Programming Instructions on page 262](#) that follow this page.
5. Set Length 2 to the maximum length using the [QR Code Length 1, Length 2 Programming Instructions on page 262](#).

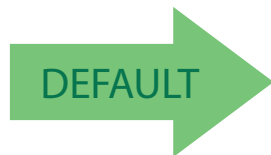

QR Code Length Control = Variable Length



QR Code Length Control = Fixed Length



QR Code Length 1, Length 2 Programming Instructions

If QR Code Length Control is set to Fixed–Length decoding, this feature specifies QR Code first fixed length. If QR Code Length Control is set to Variable–Length decoding, this feature specifies the minimum label length.



NOTE

Length 1 is the minimum label length if in variable length mode, or the first fixed length if in fixed length mode. Length 2 is the maximum label length if in variable length mode, or the second fixed length if in fixed length mode. Length includes the bar code's data characters only. Any value > 2710 will be considered to be 2710.

To set this feature:

1. Scan the ENTER/EXIT Programming Mode bar code.
2. Scan the bar code, [Set QR Code Length 1 on page 262](#) or [Set QR Code Length 2 on page 262](#) below. You'll need to cover any unused bar codes on this and the facing page to ensure that the scanner reads only the bar code you intend to scan.
3. Scan the appropriate digits from the [Alpha–Numeric Keypad in Appendix C](#) that represent the desired label length. The selectable range for this option is 0001 to 2710. Pad all numbers with leading zeros to yield a four–digit entry (001–02710).
4. Complete the programming sequence by scanning the ENTER/EXIT Programming Mode bar code.



Set QR Code Length 1
Default setting for this feature = 0001



Set QR Code Length 2
Default setting for this feature = 0A96 (length = 2710)

QR Code URL Link Enable

Enables/Disables the decoding of QR codes with a URL link on imagers other than the optional Customer Service Scanner (CSS).

To set this feature:

1. Scan the Enter/Exit Programming Mode bar code.
2. Scan either the enable or disable bar code below. You'll need to cover any unused bar codes on this and the facing page to ensure that the scanner reads only the bar code you intend to scan.
3. Complete the programming sequence by scanning the Enter/Exit Programming Mode bar code.

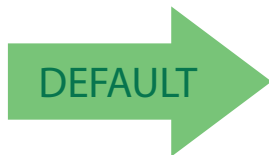

QR Code URL Link = Disable



QR Code URL Link = Enable



GS1 QR Code Enable

This feature controls the ability of the scanner to decode GS1 QR Code labels.

To set this feature:

1. Scan the Enter/Exit Programming Mode bar code.
2. Scan either the enable or disable bar code below. You'll need to cover any unused bar codes on this and the facing page to ensure that the scanner reads only the bar code you intend to scan.
3. Complete the programming sequence by scanning the Enter/Exit Programming Mode bar code.

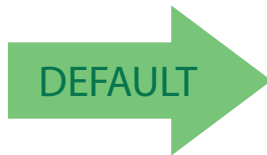

GS1 QR Code = Disable



GS1 QR Code = Enable

Micro QR Code

Micro QR Code Enable

Enables/disables the ability of the scanner to decode Micro QRCode labels.
To set this feature:

1. Scan the Enter/Exit Programming Mode bar code.
2. Scan either the enable or disable bar code below. You'll need to cover any unused bar codes on this and the facing page to ensure that the scanner reads only the bar code you intend to scan.
3. Complete the programming sequence by scanning the Enter/Exit Programming Mode bar code.

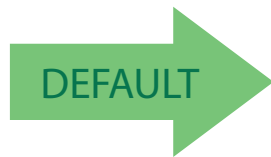

Micro QR Code = Disable



Micro QR Code = Enable



Micro QR Code Length Control

Fixed Length Decoding — When fixed length decoding is enabled, the scanner will decode a bar code if the label length matches one of the configurable fixed lengths.

Variable Length Decoding — When variable length decoding is enabled, the scanner will decode a bar code if the label length falls in the range of the configurable minimum and maximum length.

Configuring Fixed Length Decoding:

1. Scan the ENTER/EXIT Programming Mode bar code.
2. Scan the Fixed Length Decoding bar code.
3. Scan the ENTER/EXIT Programming Mode bar code.
4. Set Length 1 to the first fixed length using the [Micro QR Code Length 1, Length 2 Programming Instructions on page 267](#) that follow this page.
5. Set Length 2 to the second fixed length (or to '0000' if there is only one fixed length) using the [Micro QR Code Length 1, Length 2 Programming Instructions on page 267](#).

Configuring Variable Length Decoding:

1. Scan the ENTER/EXIT Programming Mode bar code.
2. Scan the Variable Length Decoding bar code.
3. Scan the ENTER/EXIT Programming Mode bar code.
4. Set Length 1 to the minimum length using the [Micro QR Code Length 1, Length 2 Programming Instructions on page 267](#) that follow this page.
5. Set Length 2 to the maximum length using the [Micro QR Code Length 1, Length 2 Programming Instructions on page 267](#).

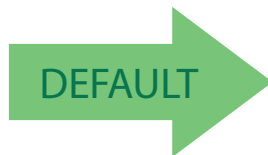

Micro QR Code Length Control = Variable Length



Micro QR Code Length Control = Fixed Length

Micro QR Code Length 1, Length 2 Programming Instructions

If Micro QR Code Length Control is set to Fixed–Length decoding, this feature specifies Micro QR Code first fixed length. If Micro QR Code Length Control is set to Variable–Length decoding, this feature specifies the minimum label length.



NOTE

Length 1 is the minimum label length if in variable length mode, or the first fixed length if in fixed length mode. **Length 2** is the maximum label length if in variable length mode, or the second fixed length if in fixed length mode. Length includes the bar code's data characters only. Any value > 3700 will be considered to be 3700.

To set this feature:

1. Scan the ENTER/EXIT Programming Mode bar code.
2. Scan the bar code, [Set Aztec Length 1 on page 270](#) or [Set Micro QR Code Length 2 on page 267](#) below. You'll need to cover any unused bar codes on this and the facing page to ensure that the scanner reads only the bar code you intend to scan.
3. Scan the appropriate digits from the [Alpha–Numeric Keypad in Appendix C](#) that represent the desired label length. The selectable range for this option is 0001 to 3700. Pad all numbers with leading zeros to yield a four–digit entry (0001–3700).
4. Complete the programming sequence by scanning the ENTER/EXIT Programming Mode bar code.



Set Micro QR Code Length 1
Default setting for this feature = 0001



Set Micro QR Code Length 2
Default setting for this feature = 0E74 (length = 3700)



Aztec Code

Aztec Enable

Enables/disables the ability of the scanner to decode Aztec labels.

To set this feature:

1. Scan the Enter/Exit Programming Mode bar code.
2. Scan either the enable or disable bar code below. You'll need to cover any unused bar codes on this and the facing page to ensure that the scanner reads only the bar code you intend to scan.
3. Complete the programming sequence by scanning the Enter/Exit Programming Mode bar code.

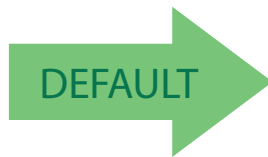

Aztec = Disable



Aztec = Enable

Aztec Length Control

Fixed Length Decoding — When fixed length decoding is enabled, the scanner will decode a bar code if the label length matches one of the configurable fixed lengths.

Variable Length Decoding — When variable length decoding is enabled, the scanner will decode a bar code if the label length falls in the range of the configurable minimum and maximum length.

Configuring Fixed Length Decoding:

1. Scan the ENTER/EXIT Programming Mode bar code.
2. Scan the Fixed Length Decoding bar code.
3. Scan the ENTER/EXIT Programming Mode bar code.
4. Set Length 1 to the first fixed length using the [Aztec Length 1, Length 2 Programming Instructions on page 270](#) that follow this page.
5. Set Length 2 to the second fixed length (or to '0000' if there is only one fixed length) using the [Aztec Length 1, Length 2 Programming Instructions on page 270](#).

Configuring Variable Length Decoding:

1. Scan the ENTER/EXIT Programming Mode bar code.
2. Scan the Variable Length Decoding bar code.
3. Scan the ENTER/EXIT Programming Mode bar code.
4. Set Length 1 to the minimum length using the [Aztec Length 1, Length 2 Programming Instructions on page 270](#) that follow this page.
5. Set Length 2 to the maximum length using the [Aztec Length 1, Length 2 Programming Instructions on page 270](#).

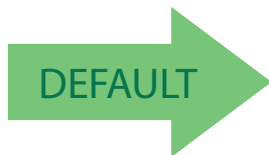

Aztec Length Control = Variable Length



Aztec Length Control = Fixed Length



Aztec Length 1, Length 2 Programming Instructions

If Aztec Length Control is set to Fixed–Length decoding, this feature specifies Aztec first fixed length. If Aztec Length Control is set to Variable–Length decoding, this feature specifies the minimum label length.



NOTE

Length 1 is the minimum label length if in variable length mode, or the first fixed length if in fixed length mode. Length 2 is the maximum label length if in variable length mode, or the second fixed length if in fixed length mode. Length includes the bar code's data characters only. Any value > 3700 will be considered to be 3700.

To set this feature:

1. Scan the ENTER/EXIT Programming Mode bar code.
2. Scan the bar code, [Set Aztec Length 1 on page 270](#) or [Set Aztec Length 2 on page 270](#) below. You'll need to cover any unused bar codes on this and the facing page to ensure that the scanner reads only the bar code you intend to scan.
3. Scan the appropriate digits from the [Alpha–Numeric Keypad in Appendix C](#) that represent the desired label length. The selectable range for this option is 0001 to 3700. Pad all numbers with leading zeros to yield a four–digit entry (0001–3700).
4. Complete the programming sequence by scanning the ENTER/EXIT Programming Mode bar code.



Set Aztec Length 1
Default setting for this feature = 0001



Set Aztec Length 2
Default setting for this feature = 0E74 (length = 3700)



Chapter 3 References

This section contains explanations and examples of selected bar code features. See the programming sections for the actual bar code labels used to configure the reader.

Global Prefix/Suffix

Up to 20 ASCII characters may be added as a prefix (in a position before the bar code data) and/or as a suffix (in a position following the bar code data) as indicated in Figure 9.

Figure 9. Prefix and Suffix Positions

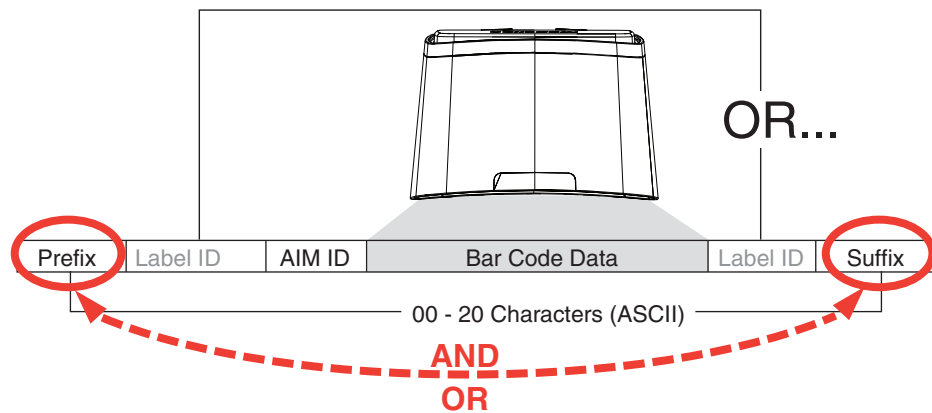

Example: Setting a Prefix

In this example, we'll set a prefix for all symbologies.

1. Determine which ASCII character(s) are to be added to scanned bar code data. In this example, we'll add a dollar sign ('\$') as a prefix.
2. Scan the Enter/Exit Programming Mode bar code.
3. Scan the SET PREFIX bar code.
4. Reference the [ASCII Character Set on page i](#) on the inside back cover of this manual, to find the hex value assigned to the desired character. The corresponding hex number for the '\$' character is 24. To enter this selec-

tion code, scan the '2' and '4' bar codes from [Appendix C, Alpha-Numeric Keypad](#).

5. Scan the END bar code once to finish the string, then scan END again to exit Programming Mode.

**NOTE**

If all 20 characters will be used in the prefix or suffix, do not scan the END bar code to finish the string. It is done automatically.

6. The resulting message string would appear as follows:

Scanned bar code data:12345

Resulting message string output: \$12345

Label ID

A Label ID is used to identify a bar code (symbology) type. See [Appendix D, Factory Default Settings](#), for a listing for common symbologies. It can be appended previous to or following the transmitted bar code data depending upon how this option is enabled. This feature provides options for configuring custom Label IDs individually per symbology. If you wish to program the scanner to always include an industry standard label identifier for ALL symbology types, see the feature, [AIM ID](#) on page 2–91.

The Label ID is a customizable code of up to three ASCII characters (each of which are 00–7F) followed by a control character (00–01). This control character, when set to zero, does nothing. When set to one, it appends the symbology's AIM ID to the Label ID.

**NOTE**

When the control character is set to 01 for UPC-A and UPC-E, it expands the label to EAN-13 and thus follows the EAN-13 Label ID settings.

To configure a Label ID:

1. Scan the Enter/Exit Programming Mode bar code.
2. Select Label ID position as either BEFORE or AFTER by scanning the appropriate bar code.
3. Scan a bar code to select the symbology for which you wish to configure a custom Label ID.
4. Determine the desired character(s) (you may choose up to three) which will represent the Label ID for the selected symbology. Next, turn to the [ASCII Character Set on page i](#) on the inside back cover of this manual and find the equivalent hex digits associated with your choice of Label ID. For example, if you wish to select an equal sign (=) as a Label ID, the chart indicates its associated hex characters as 3D.
5. Turn to [Appendix C](#) and scan the bar codes representing the hex characters determined in the previous step. For example, to make an equal sign (=), scan '3' and 'D' followed by '0' six times. Since this is a three-character buffer, '00' is scanned for character two, '00' for character three and '00' for the control character. ('00' indicates no character.)
6. Scan the END bar code to exit programming mode.

Figure 10. Label ID Position Options

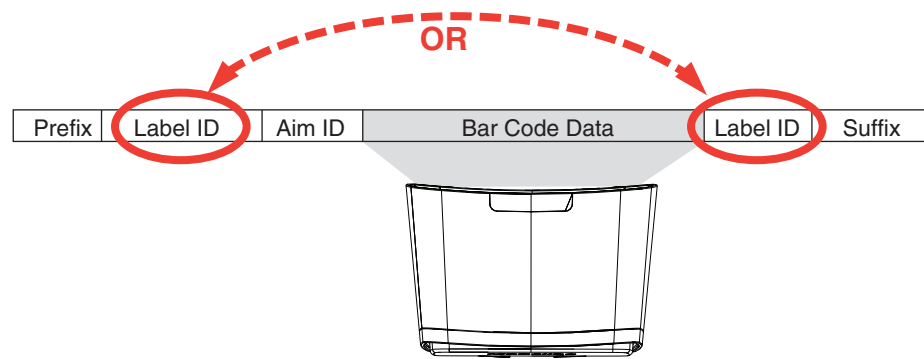

Length Control

Fixed Length Decoding — When fixed length decoding is enabled, the scanner will decode a bar code if the label length matches one of the configurable fixed lengths.

Variable Length Decoding — When variable length decoding is enabled, the scanner will decode a bar code if the label length falls in the range of the configurable minimum and maximum length.

Configuring Fixed Length Decoding:

1. Scan the Enter/Exit Programming Mode bar code.
2. Scan the Fixed Length Decoding bar code for the desired symbology.
3. Scan the Enter/Exit Programming Mode bar code.
4. Set Length 1 to the first fixed length by following the [Length 1, Length 2 Programming Instructions](#) below.
5. Set Length 2 to the second fixed length (or to '00' if there is only one fixed length) by following the [Length 1, Length 2 Programming Instructions](#) below.

Configuring Variable Length Decoding:

1. Scan the Enter/Exit Programming Mode bar code.
2. Scan the Variable Length Decoding bar code for the desired symbology.
3. Scan the Enter/Exit Programming Mode bar code.
4. Set Length 1 to the first variable length by following the [Length 1, Length 2 Programming Instructions](#) below.
5. Set Length 2 to the second variable length by following the [Length 1, Length 2 Programming Instructions](#) below.

Length 1, Length 2 Programming Instructions

1. Scan the Enter/Exit Programming Mode bar code.
2. Scan either the Set Length 1 or Set Length 2 bar code for the desired symbology.
3. Turn to [Appendix C](#) and scan the two digits (zero padded) representing the length in decimal notation. The number of characters that can be set varies, depending upon the symbology. Reference the page for your selected symbology to see specific variables.
4. Scan the Enter/Exit Programming Mode bar code



Appendix A

Product Specifications

Decoding Capability

Parameter	Specification
1D / Linear Codes	Autodiscriminates All Standard 1D Codes Including GS1 Databar™ Linear Codes.
2D Codes	Aztec Code; Data Matrix (ECC200 Only); QR Code
Stacked Codes	GS1 Databar Composites; GS1 Databar Expanded Stacked; GS1 Databar Stacked; GS1 Databar Stacked Omnidirectional; Micro-PDF417; PDF417
Digital Watermarks	Optional Support For Digimarc® Barcodes/GS1 DW Code

Electrical Specifications

Parameter	Specification
AC Power Requirements	AC Input: 100-240 Vac, 50-60 Hz; DC Input: 5-12 V
Power Consumption	Operating (Maximum): 3.8 Watts; Operating (Nominal): 3.6 Watts Sleep Mode: 3.0 Watts

Environmental

Parameter	Specification
Ambient Light	0 - 86,100 Lux
ESD Protection (Air Discharge)	25 kV
Humidity (Non-condensing)	5 - 95%
Particulate And Water Sealing	IP52
Temperature	Operating: 0 to 40 °C / 32 to 104 °F Storage/transport: -40 to 70 °C / -40 to 158 °F

Interfaces

Parameter	Specification
Interfaces	OEM (IBM) USB; RS-232; USB Keyboard; USB COM Powered Type A USB (USB Com)

Optional Features

Parameter	Specification
EAS Features	Good Read signal available for use with various EAS hardware, such as Checkpoint Systems and Sensormatic devices.
Value Added Features	Diagnostic Reporting; Host Download; Magellan ULE Scripting

Physical Characteristics

Parameter	Specification
Dimensions	Magellan Model 3450VSi: 13.7 X 15.2 X 9.4 cm / 5.4 X 6.0 X 3.7 in
Weight	0.6 kg / 1.3 lb

Scanner Dimensions

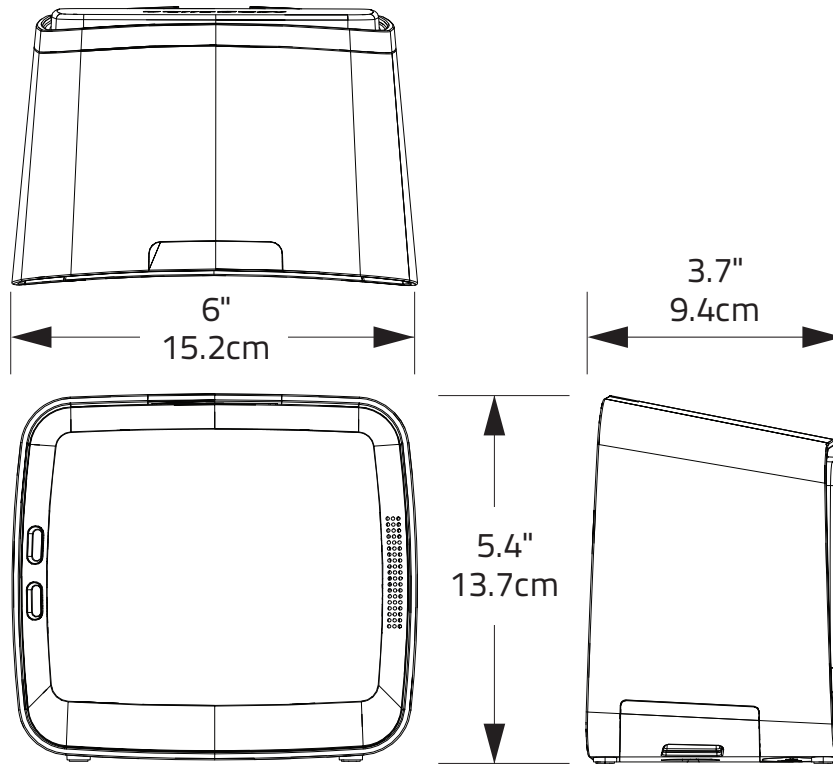

Reading Performance

Parameter	Specification
Image Capture	Graphic Formats: BMP, JPEG
Imager Sensor	1280 X 1024
Light Source	Multiple Diffused LEDS, Orientation and Wavelength Optimized for Eye Comfort
Print Contrast Ratio (Minimum)	25%
Read Height	14.0 cm / 5.5 in
Read Rate (Maximum)	39 Million Pixels per Second
Reading Angle	Pitch: +/- 65°; Roll (Tilt): 0 - 360°; Skew (Yaw): +/- 75°
Reading Indicators	Audio Speaker w/Adjustable Tone and Volume, Supports .wav Files; Good Read LED; Good Transmission
Resolution (Maximum)	5 Mil

Reading Ranges

Parameter	Specification
Typical Depth Of Field	Printing Resolution, Symbol Length, Scan Angle, Contrast and Ambient Light Dependent
1D / Linear Codes	5 Mils: 3.8 to 8.1 cm / 1.5 to 3.2 in
	7.5 Mils: 1.3 to 11.4 cm / 0.5 to 4.5 in
	10 Mils: 0 to 15.2 cm / 0 to 6.0 in
	13 Mils: 0 to 20.3 cm / 0 to 8.0 in
2D Codes (Optional)	6.6 Mils: PDF: 3.8 to 10.2 cm / 1.5 to 4.0 in
	10 Mils: PDF: 0 to 12.7 cm / 0 to 5.0 in
	10 Mils: Data Matrix: 1.3 to 6.4 cm / 0.5 to 2.5 in
	20 Mils: Data Matrix: 0 to 18.0 cm / 0 to 7.0 in

Safety & Regulatory

Parameter	Specification
Agency Approvals	The product meets necessary safety and regulatory approvals for its intended use.
Environmental Compliance	Complies to China RoHS; Complies to EU RoHS
LED Classification	EN62471 and IEC62471 Lamp Illumination - Exempt Group

Utilities

Parameter	Specification
Scanalyzer	Magellan Scanalyzer Configuration Software is available for download at no charge.
OPOS / JavaPOS	JavaPOS Utilities are available for download at no charge. OPOS Utilities are available for download at no charge.

Warranty

Warranty	3-year Factory Warranty
----------	-------------------------

LED and Beeper Indicators

The scanner's beeper sounds and its green LED illuminates to indicate various functions or errors on the scanner. The tables below list these indications. The scanner's functions are programmable, and so may or may not be turned on. For example, certain indications such as the power-up beep can be disabled using programming bar code labels.

LED INDICATION	INDICATION	COMMENT
Power-on indication	Bright green flash	Indicates the scanner has finished all its power up tests and is now ready for operation.
Good Read Indication	Bright green flash	Indicates a bar code has been read and decoded.
Scanner Ready	Constant dim green	The scanner is ready for operation. The LED is also configurable to off when idle and ready for operation
Sleep Mode	Green LED slowly and continuously changes from off to dim to off.	The scanner is in Sleep Mode. To wake the scanner up, move an object in front of its window or press the button atop the unit. This indication is configurable and may be programmed to behave differently.
Host Disable	Constant green flash at 1 Hz (100mS on, 900mS off)	The scanner is disabled due to receiving a disable command from the POS terminal.
Diagnostics	Varies (see Error Codes on page 281 for more information)	The LED can provide diagnostic feedback if the scanner discovers a problem during SelfTest.
Prog. Mode	See Host Disable above.	The scanner is in Programming Mode.

BEEPER FUNCTIONS

BEEPER INDICATION	INDICATION	COMMENT
Power On Beep	Single beep	The Power-On Beep indication is a configurable feature which can be enabled or disabled. When enabled, this beep indicates the scanner has finished all its power up tests and is now ready for operation.
Good Read Indication	Single beep	The good read beep indication is configurable. Options include: Enable/disable, frequency, duration and volume. See LED and Beeper Indicators on page 2-57 for more information.
Diagnostics	Varies (see “Error Codes” for more information)	The Beeper can provide diagnostic feedback if the scanner discovers a problem during SelfTest.
Programming Mode Indications	Varies depending upon the feature(s) being configured.	The Beeper will sound as programming bar code labels are scanned, indicating progress during scanner configuration.

Error Codes

If an error is detected, the scanner will sound a long low tone (for three seconds) and flash its LED, indicating a failure. When this occurs, press the Scanner Pushbutton to hear the error code. If it is configured to do so, the scanner will sound a series of beeps corresponding to the error code and/or flash its LED simultaneous to the beeps. The table below describes what these codes mean and what action should be taken for each.

NUMBER OF LED FLASHES/ BEEPS	ERROR	CORRECTIVE ACTION
1	Configuration	Contact Helpdesk for assistance
2	Interface PCB	
6	Main PCB	
10	Button Error	
12	Imager Module	
13	Software ID Failure	
14	Software Fatal Fault	



Appendix B Cable Pinouts

Standard Cable Pinouts (Primary Interface Cables)

Pin #	RS-232	USB-OEM	USB, USB Keyboard, USB COM
1		D+	D+
2	CTS		
3		D-	D-
4	RTS		
5	RxD		
6	TxD		
7			
8	Vin	Vin/VBUS	Vin/VBUS
9	GND	GND	GND
10	ERI	ERI	ERI



Appendix C

Alpha-Numeric Keypad



A



B

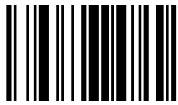

C



D



E



F



1



NOTE

For numeric entry sequences, the scanner will announce the number of digits remaining to be entered after each label read.



2



3



4



5



6



7



8



9



0



Appendix D

Factory Default Settings

The following table provides a listing of the most common factory settings for the interfaces shown.



NOTE

Some of the individual interfaces listed in the defaults table below appear in the same column since they share similar feature settings with few (if any) exceptions.

Keep in mind though, that the actual configuration storage area for each interface is unique and that updates & changes to factory defaults can be made at any time without notice.

Factory Default Settings

Feature	Default Master	RS-232	RS-232 Wincor-Nixdorf	Keyboard	USB COM / USB TEC	USB OEM
General Scanner Features						
1D Double Read Timeout on page 12	28 (400ms)	28 (400ms)	28 (400ms)	28 (400ms)	28 (400ms)	28 (400ms)
2D Double Read Timeout on page 13	46 (700ms)	46 (700ms)	46 (700ms)	46 (700ms)	46 (700ms)	46 (700ms)
Digital Watermark (Digimarc) Enable on page 14	01 (enable)	01 (enable)	01 (enable)	01 (enable)	01 (enable)	01 (enable)
Digital Watermark (Digimarc) Double Read Timeout on page 15	0.5 Sec.	0.5 Sec.	0.5 Sec.	0.5 Sec.	0.5 Sec.	0.5 Sec.
Digital Watermark (Digimarc) Data Format on page 16	00 (compatibility mode)	00 (compatibility mode)	00 (compatibility mode)	00 (compatibility mode)	00 (compatibility mode)	00 (compatibility mode)
Sleep Mode Timer on page 17	5 minutes	5 minutes	5 minutes	5 minutes	5 minutes	5 minutes
1D Inverse Read Control on page 18	0000 (disable)	0000 (disable)	0000 (disable)	0000 (disable)	0000 (disable)	0000 (disable)
2D Inverse Read Control on page 19	00 (disable)	00 (disable)	00 (disable)	00 (disable)	00 (disable)	00 (disable)
on page 21	01 (enable)	01 (enable)	01 (enable)	01 (enable)	01 (enable)	01 (enable)
Object Sense Control on page 23	40 (enable)	40 (enable)	40 (enable)	40 (enable)	40 (enable)	40 (enable)

Feature	Default Master	RS-232	RS-232 Wincor-Nixdorf	Keyboard	USB COM / USB TEC	USB OEM
Reading Illumination Duration on page 20	64 (5 sec)	64 (5 sec)	64 (5 sec)	64 (5 sec)	64 (5 sec)	64 (5 sec)
Good Read LED Idle State on page 27	02 (on dim)	02 (on dim)	02 (on dim)	02 (on dim)	02 (on dim)	02 (on dim)
Scanner Control Button Options on page 28	01	01	01	01	01	01
Good Read Beep Control on page 29	01 (enable)	01 (enable)	01 (enable)	01 (enable)	01 (enable)	01 (enable)
Good Read Beep Frequency on page 30	01 (med.)	01 (med.)	01 (med.)	01 (med.)	01 (med.)	01 (med.)
Good Read Beep Length on page 31	008 (80ms)	008 (80ms)	008 (80ms)	008 (80ms)	008 (80ms)	008 (80ms)
Good Read Beep Volume on page 32	02 (med)	02 (med)	02 (med)	02 (med)	02 (med)	02 (med)
Good Read When to Indicate on page 33	00 (after decode)	00 (after decode)	00 (after decode)	00 (after decode)	00 (after decode)	00 (after decode)
Handheld Host Download Timeout on page 34	0F (15 seconds)	0F (15 seconds)	0F (15 seconds)	0F (15 seconds)	0F (15 seconds)	0F (15 seconds)
Imaging Features						
Camera Button Mode on page 37	00 (disable)	00 (disable)	00 (disable)	00 (disable)	00 (disable)	00 (disable)
Image Destination on page 38	00 (disable)	00 (disable)	00 (disable)	00 (disable)	00 (disable)	00 (disable)
Cell Phone Mode on page 39	02 (Enable)	02 (Enable)	02 (Enable)	02 (Enable)	02 (Enable)	02 (Enable)
Cell Mode Percent on page 40	00 (Very Low)	00 (Very Low)	00 (Very Low)	00 (Very Low)	00 (Very Low)	00 (Very Low)
Picture Retrieval Timeout on page 41	05 (5 sec.)	05 (5 sec.)	05 (5 sec.)		05 (5 sec.)	05 (5 sec.)
Image Capture Delay on page 43	05 (5 sec.)	05 (5 sec.)	05 (5 sec.)	05 (5 sec.)	05 (5 sec.)	05 (5 sec.)
Image Format on page 44	00 (JPG)	00 (JPG)	00 (JPG)	00 (JPG)	00 (JPG)	00 (JPG)
Image Size on page 45	00 (VGA)	00 (VGA)	00 (VGA)	00 (VGA)	00 (VGA)	00 (VGA)
Image Brightness on page 46	Level 0	Level 0	Level 0	Level 0	Level 0	Level 0

Feature	Default Master	RS-232	RS-232 Wincor-Nixdorf	Keyboard	USB COM / USB TEC	USB OEM
Image Contrast on page 48	Level 0	Level 0	Level 0	Level 0	Level 0	Level 0
Image Compression on page 50	64 (Compression = 100)	64 (Compression = 100)	64 (Compression = 100)	64 (Compression = 100)	64 (Compression = 100)	64 (Compression = 100)
Region of Interest (ROI) on page 51	000004FF00003FF (full size)	000004FF00003FF (full size)	000004FF00003FF (full size)	000004FF00003FF (full size)	000004FF00003FF (full size)	000004FF00003FF (full size)
Interface Related Features						
Maximum Host-Transmitted Message Length on page 58	000 (no gen. limit imposed)	000 (no gen. limit imposed)	000 (no gen. limit imposed)	000 (no gen. limit imposed)	000 (no gen. limit imposed)	000 (no gen. limit imposed)
RS-232 Baud Rate on page 59	01 (9600)	01 (9600)	01 (9600)		01 (9600)	
RS-232 Number of Data Bits on page 61	01 (8 data bits)	01 (8 data bits)	01 (8 data bits)		01 (8 data bits)	
RS-232 Number of Stop Bits on page 61	00 (1 stop bit)	00 (1 stop bit)	00 (1 stop bit)		00 (1 stop bit)	
RS-232 Parity on page 62	00 (none)	00 (none)	02 (odd)		00 (none)	
RS-232 Hardware Control on page 63	00 (disable)	00 (disable)	01 (enable CTS flow control)		00 (disable)	
RS-232 Intercharacter Delay on page 64	00 (no delay)	00 (no delay)	00 (no delay)		00 (no delay)	
RS-232 Software Flow Control on page 65	00 (disable)	00 (disable)	00 (disable)		00 (disable)	
RS-232 Beep on ASCII BEL on page 66	00 (disable)	00 (disable)	00 (disable)		00 (disable)	
Beep on Not on File on page 66	01 (low vol)	01 (low vol)	01 (low vol)		01 (low vol)	01 (low vol)
ACK NAK Enable on page 67	00 (disable)	00 (disable)	00 (disable)		00 (disable)	
RS-232 ACK Character on page 68	06 (ACK)	06 (ACK)	06 (ACK)		06 (ACK)	
RS-232 NAK Character on page 69	15 (NAK)	15 (NAK)	15 (NAK)		15 (NAK)	
RS-232 Retry on ACK NAK Timeout on page 70	01 (enable)	01 (enable)	01 (enable)		01 (enable)	

Feature	Default Master	RS-232	RS-232 Wincor-Nixdorf	Keyboard	USB COM / USB TEC	USB OEM
RS-232 ACK NAK Timeout Value on page 71	01 (200ms)	01 (200ms)	01 (200ms)		01 (200ms)	
RS-232 ACK NAK Retry Count on page 72	03 (3 retries)	03 (3 retries)	03 (3 retries)		03 (3 retries)	
RS-232 ACK NAK Error Handling on page 73	00 (ignore)	00 (ignore)	00 (ignore)		00 (ignore)	
RS-232 Indicate Transmission Failure on page 74	01 (enable)	01 (enable)	01 (enable)		01 (enable)	
RS-232 Ignore Host Commands on page 75	00	00	00	00	00	00
USB-OEM Interface Features on page 76	02	02	02	02	02	01
USB OEM Scanner Device Type on page 76	00 (table top)					00 (table top)
USB OEM Additional Interface Options on page 77	00 (disabled upon enumeration)					00 (disabled upon enumeration)
USB Keyboard Country Mode on page 78	00 (USA)			00 (USA)		
USB Keyboard Caps Lock State on page 81	00 (caps lock OFF)			00 (caps lock OFF)		
No Keyboard Support on page 82	00 (disable)			00 (disable)		
USB Keyboard Send Control Characters on page 83	00 (disable)			00 (disable)		
Quiet Interval on page 84	0A (100ms)			0A (100ms)		
USB Keyboard Inter-character Delay on page 85	01 (10ms)			01 (10ms)		
USB Keyboard Additional Interface Options on page 86	40 (Rev D)	00	00	40 (Rev D)	40 (Rev D)/00	46

Feature	Default Master	RS-232	RS-232 Wincor-Nixdorf	Keyboard	USB COM / USB TEC	USB OEM
Data Editing						
Global Prefix on page 89	00 (no prefix)	00 (no prefix)	00 (no prefix)	00 (no prefix)	00 (no prefix)	00 (no prefix)
Global Suffix on page 90	0D00 (CR)	0D00 (CR)	0D00 (CR)	0D00 (CR)	0D00 (CR)	0D00 (CR)
AIM ID on page 91	00 (disable)	00 (disable)	00 (disable)	00 (disable)	00 (disable)	
Label ID on page 92	01 (Enable as prefix)	01 (Enable as prefix)	01 (Enable as prefix)	01 (Enable as prefix)	01 (Enable as prefix)	
Global Mid-Label ID on page 100	00 (no mid-label ID)	00 (no mid-label ID)	00 (no mid-label ID)	00 (no mid-label ID)	00 (no mid-label ID)	
Case Conversion on page 101	00 (no case convers'n)	00 (no case convers'n)	00 (no case convers'n)	00 (no case convers'n)	00 (no case convers'n)	00 (no case convers'n)
Character Conversion on page 102	FFFFFFFF FFFFF (no char. convers'n)	FFFFFFFF FFFFF (no char. convers'n)	FFFFFFFF FFFFF (no char. convers'n)	FFFFFFFF FFFFF (no char. convers'n)	FFFFFFFF FFFFF (no char. convers'n)	FFFFFFFF FFFFF (no char. convers'n)
1D Symbology Programming						
Coupon Control Enable on page 104	01 (enable UPC-A)	03 (UPC-A coupon priority)	03 (UPC-A coupon priority)	03 (UPC-A coupon priority)	03 (UPC-A coupon priority)	03 (UPC-A coupon priority)
Coupon Label Priority Timer on page 105	0.2 Sec.	0.2 Sec.	0.2 Sec.	0.2 Sec.	0.2 Sec.	0.2 Sec.
UPC-A Enable on page 106	01 (enable)	01 (enable)	01 (enable)	01 (enable)	01 (enable)	01 (enable)
UPC-A Number System Character Transmission on page 107	01 (enable)	01 (enable)	01 (enable)	01 (enable)	01 (enable)	01 (enable)
UPC-A Check Character Transmission on page 108	01 (enable)	01 (enable)	01 (enable)	01 (enable)	01 (enable)	01 (enable)
UPC-A Minimum Read on page 109	01 (1 read)	01 (1 read)	01 (1 read)	01 (1 read)	01 (1 read)	01 (1 read)
Expand UPC-A to EAN-13 on page 110	00 (disable)	00 (disable)	01 (enable)	00 (disable)	00 (disable)	00 (disable)
UPC-E Enable on page 111	01 (enable)	01 (enable)	01 (enable)	01 (enable)	01 (enable)	01 (enable)
UPC-E Number System Character Transmission on page 112	01 (enable)	01 (enable)	01 (enable)	01 (enable)	01 (enable)	01 (enable)

Feature	Default Master	RS-232	RS-232 Wincor-Nixdorf	Keyboard	USB COM / USB TEC	USB OEM
UPC-E Check Character Transmission on page 113	01 (enable)	01 (enable)	00 (disable)	01 (enable)	01 (enable)	01 (enable)
Expand UPC-E to UPC-A on page 114	00 (disable)	00 (disable)	00 (disable)	00 (disable)	00 (disable)	00 (disable)
Expand UPC-E to EAN-13 on page 115	00 (disable)	00 (disable)	00 (disable)	00 (disable)	00 (disable)	00 (disable)
UPC-E Minimum Read on page 116	01 (1 read)	01 (1 read)	01 (1 read)	01 (1 read)	01 (1 read)	01 (1 read)
EAN-13 on page 117	01 (enable)	01 (enable)	01 (enable)	01 (enable)	01 (enable)	01 (enable)
EAN-13 First Character Transmission on page 118	01 (enable)	01 (enable)	01 (enable)	01 (enable)	01 (enable)	01 (enable)
EAN-13 Check Character Transmission on page 119	01 (enable)	01 (enable)	01 (enable)	01 (enable)	01 (enable)	01 (enable)
EAN-13 ISBN Conversion Enable on page 120	00 (disable)	00 (disable)	00 (disable)	00 (disable)	00 (disable)	00 (disable)
EAN-13 Minimum Read on page 121	01 (1 read)	01 (1 read)	01 (1 read)	01 (1 read)	01 (1 read)	01 (1 read)
EAN-8 on page 122	01 (enable)	01 (enable)	01 (enable)	01 (enable)	01 (enable)	01 (enable)
EAN-8 Check Character Transmission on page 123	01 (enable)	01 (enable)	01 (enable)	01 (enable)	01 (enable)	01 (enable)
Expand EAN-8 to EAN-13 on page 124	00 (disable)	00 (disable)	00 (disable)	00 (disable)	00 (disable)	00 (disable)
EAN-8 Minimum Read on page 125	01 (1 read)	01 (1 read)	01 (1 read)	01 (1 read)	01 (1 read)	01 (1 read)
EAN-8 Guard Insertion on page 126	00 (disable)	00 (disable)	00 (disable)	00 (disable)	00 (disable)	00 (disable)
EAN-8 Guard Substitution on page 127	00 (disable)	00 (disable)	00 (disable)	00 (disable)	00 (disable)	00 (disable)
EAN-8/Jan-8 Both Guards Substitution on page 128	00 (disable)	00 (disable)	00 (disable)	00 (disable)	00 (disable)	00 (disable)
EAN-8 Stitch Exact Label Halves on page 129	00 (disable)	00 (disable)	00 (disable)	00 (disable)	00 (disable)	00 (disable)

Feature	Default Master	RS-232	RS-232 Wincor-Nixdorf	Keyboard	USB COM / USB TEC	USB OEM
EAN-8 Stitch Unlike Label Halves on page 130	00 (disable)	00 (disable)	00 (disable)	00 (disable)	00 (disable)	00 (disable)
EAN-8 Minimum Segment Length on page 131	08	08	08	08	08	08
EAN-8 Decoding Levels on page 133	01 (very conservative)	01 (very conservative)	01 (very conservative)	01 (very conservative)	01 (very conservative)	01 (very conservative)
In-Store Printed Label Minimum Read on page 135	01 (1 read)	01 (1 read)	01 (1 read)	01 (1 read)	01 (1 read)	01 (1 read)
UPC/EAN Correlation on page 136	00 (disable)	00 (disable)	00 (disable)	00 (disable)	00 (disable)	00 (disable)
UPC/EAN Guard Insertion on page 137	00 (disable)	00 (disable)	00 (disable)	00 (disable)	00 (disable)	00 (disable)
UPC/EAN Stitch Exact Label Halves on page 138	00 (disable)	00 (disable)	00 (disable)	00 (disable)	00 (disable)	00 (disable)
UPC/EAN Stitch Unlike Label Halves on page 139	00 (disable)	00 (disable)	00 (disable)	00 (disable)	00 (disable)	00 (disable)
UPC/EAN Minimum Segment Length on page 140	05 (5 char.)	05 (5 char.)	05 (5 char.)	05 (5 char.)	05 (5 char.)	05 (5 char.)
Price Weight Check on page 142	00 (disable)	00 (disable)	00 (disable)	00 (disable)	00 (disable)	00 (disable)
Enable EAN Two Label on page 144	00 (disable)	00 (disable)	00 (disable)	00 (disable)	00 (disable)	00 (disable)
EAN Two Label Minimum Read on page 145	01 (1 read)	01 (1 read)	01 (1 read)	01 (1 read)	01 (1 read)	01 (1 read)
EAN Two Label Combined Transmission on page 146	00 (disable)	00 (disable)	00 (disable)	00 (disable)		
Add-ons on page 147	disable all	disable all	disable all	disable all	disable all	disable all
P2 Add-on Minimum Read on page 148	02 (2 reads)	02 (2 reads)	02 (2 reads)	02 (2 reads)	02 (2 reads)	02 (2 reads)
P5 Add-on Minimum Read on page 151	01 (1 read)	01 (1 read)	01 (1 read)	01 (1 read)	01 (1 read)	01 (1 read)
UPC/EAN Composites on page 154	00 (disable)	00 (disable)	00 (disable)	00 (disable)	00 (disable)	

Feature	Default Master	RS-232	RS-232 Wincor-Nixdorf	Keyboard	USB COM / USB TEC	USB OEM
GTIN on page 155	00 (disable)	00 (disable)	00 (disable)	00 (disable)	00 (disable)	
DataBar Omnidirectional Enable on page 156	00 (disable)	00 (disable)	00 (disable)	00 (disable)	00 (disable)	00 (disable)
DataBar Omnidirectional/EAN-128 Emulation on page 157	00 (disable)	00 (disable)	00 (disable)	00 (disable)	00 (disable)	00 (disable)
DataBar Omnidirectional 2D Component Enable on page 158	00 (disable)	00 (disable)	00 (disable)	00 (disable)	00 (disable)	00 (disable)
DataBar Omnidirectional Minimum Read on page 159	01 (1 read)	01 (1 read)	01 (1 read)	01 (1 read)	01 (1 read)	01 (1 read)
DataBar Omnidirectional Double Read Timeout on page 160	2.5 Sec.	2.5 Sec.	2.5 Sec.	2.5 Sec.	2.5 Sec.	2.5 Sec.
DataBar Limited Enable on page 162	00 (disable)	00 (disable)	00 (disable)	00 (disable)	00 (disable)	00 (disable)
DataBar Limited Minimum Read on page 163	01 (1 read)	01 (1 read)	01 (1 read)	01 (1 read)	01 (1 read)	01 (1 read)
DataBar Limited 2D Component Enable on page 164	00 (disable)	00 (disable)	00 (disable)	00 (disable)	00 (disable)	00 (disable)
DataBar Limited EAN128 Emulation Enable on page 165	00 (disable)	00 (disable)	00 (disable)	00 (disable)	00 (disable)	00 (disable)
DataBar Expanded on page 166	00 (disable)	00 (disable)	00 (disable)	00 (disable)	00 (disable)	00 (disable)
DataBar Expanded EAN-128 Emulation on page 167	00 (disable)	00 (disable)	00 (disable)	00 (disable)	00 (disable)	00 (disable)
DataBar Expanded 2D Component Enable on page 168	00 (disable)	00 (disable)	00 (disable)	00 (disable)	00 (disable)	00 (disable)
DataBar Expanded Minimum Read on page 169	01 (1 read)	01 (1 read)	01 (1 read)	01 (1 read)	01 (1 read)	01 (1 read)
DataBar Expanded Length Control on page 170	00 (variable)	00 (variable)	00 (variable)	00 (variable)	00 (variable)	00 (variable)

Feature	Default Master	RS-232	RS-232 Wincor-Nixdorf	Keyboard	USB COM / USB TEC	USB OEM
DataBar Expanded Length 1 on page 171	01	01	01	01	01	01
DataBar Expanded Length 2 on page 172	4A	4A	4A	4A	4A	4A
DataBar Expanded Reverse Retry on page 173	00 (disable)	00 (disable)	00 (disable)	00 (disable)	00 (disable)	00 (disable)
Code 39 on page 174	01 (enable)	01 (enable)	01 (enable)	01 (enable)	01 (enable)	01 (enable)
Code 39 Start Stop Character Transmission on page 175	00 (disable)	00 (disable)	00 (disable)	00 (disable)	00 (disable)	00 (disable)
Code 39 Check Character Calculation on page 176	00 (disable)	00 (disable)	00 (disable)	00 (disable)	00 (disable)	00 (disable)
Code 39 Check Character Transmission on page 177	01 (enable)	01 (enable)	01 (enable)	01 (enable)	01 (enable)	01 (enable)
Code 39 Full ASCII on page 178	00 (disable)	00 (disable)	00 (disable)	00 (disable)	00 (disable)	00 (disable)
Code 39 Minimum Read on page 179	01 (1 read)	01 (1 read)	01 (1 read)	01 (1 read)	01 (1 read)	01 (1 read)
Code 39 Correlation on page 180	00 (disable)	00 (disable)	00 (disable)	00 (disable)	00 (disable)	00 (disable)
Code 39 Length Control on page 181	00 (variable)	00 (variable)	00 (variable)	00 (variable)	00 (variable)	00 (variable)
Code 39 Length 1 on page 182	02	02	02	02	02	02
Code 39 Length 2 on page 183	32	32	32	32	32	32
Code 39 Stitching on page 184	01 (enable)	01 (enable)	01 (enable)	01 (enable)	01 (enable)	01 (enable)
Code 39 Require Margins on page 185	00 (disable)	00 (disable)	00 (disable)	00 (disable)	00 (disable)	00 (disable)
Code 32 Italian Pharmacode on page 186	00 (disable)	00 (disable)	00 (disable)	00 (disable)	00 (disable)	00 (disable)
Code 32 Start Stop Character Transmission on page 187	00 (disable)	00 (disable)	00 (disable)	00 (disable)	00 (disable)	00 (disable)

Feature	Default Master	RS-232	RS-232 Wincor-Nixdorf	Keyboard	USB COM / USB TEC	USB OEM
Code 32 Check Character Transmission on page 188	00 (disable)	00 (disable)	00 (disable)	00 (disable)	00 (disable)	
Code 128 on page 189	01 (enable)	01 (enable)	01 (enable)	01 (enable)	01 (enable)	01 (enable)
Code 128 Transmit Function Characters on page 190	00 (disable)	00 (disable)	00 (disable)	00 (disable)	00 (disable)	00 (disable)
Expand Code128 to Code 39 on page 191	00 (disable)	00 (disable)	00 (disable)	00 (disable)	00 (disable)	00 (disable)
Code 128 Minimum Read on page 192	01 (1 read)	01 (1 read)	01 (1 read)	01 (1 read)	01 (1 read)	01 (1 read)
Code 128 Correlation on page 193	00 (disable)	00 (disable)	00 (disable)	00 (disable)	00 (disable)	00 (disable)
Code 128 Length Control on page 194	00 (variable)	00 (variable)	00 (variable)	00 (variable)	00 (variable)	00 (variable)
Code 128 Length 1 on page 195	01	01	01	01	01	01
Code 128 Length 2 on page 196	50	50	50	50	50	50
Code 128 Stitching on page 197	01 (enable)	01 (enable)	01 (enable)	01 (enable)	01 (enable)	01 (enable)
EAN-128 on page 198	00 (disable)	00 (disable)	00 (disable)	00 (disable)	00 (disable)	00 (disable)
Interleaved 2 of 5 (I 2 OF 5) on page 199	00 (disable)	00 (disable)	00 (disable)	00 (disable)	00 (disable)	00 (disable)
I 2 of 5 Check Character Calculation on page 200	00 (disable)	00 (disable)	00 (disable)	00 (disable)	00 (disable)	00 (disable)
I 2 of 5 Check Character Transmission on page 201	01 (enable)	01 (enable)	01 (enable)	01 (enable)	01 (enable)	01 (enable)
I 2 of 5 Minimum Read on page 202	01 (1 read)	01 (1 read)	01 (1 read)	01 (1 read)	01 (1 read)	01 (1 read)
I 2 of 5 Correlation on page 203	00 (disable)	00 (disable)	00 (disable)	00 (disable)	00 (disable)	00 (disable)
I 2 of 5 Length Control on page 204	00 (variable)	00 (variable)	00 (variable)	00 (variable)	00 (variable)	00 (variable)
I 2 of 5 Length 1 on page 205	06	06	06	06	06	06
I 2 of 5 Length 2 on page 206	32	32	32	32	32	32

Feature	Default Master	RS-232	RS-232 Wincor-Nixdorf	Keyboard	USB COM / USB TEC	USB OEM
1 2 of 5 Stitching on page 207	00 (disable)	00 (disable)	00 (disable)	00 (disable)	00 (disable)	00 (disable)
Codabar on page 208	00 (disable)	00 (disable)	00 (disable)	00 (disable)	00 (disable)	00 (disable)
Codabar Start Stop Character Transmission on page 209	01 (enable)	01 (enable)	01 (enable)	01 (enable)	01 (enable)	01 (enable)
Codabar Start Stop Character Set on page 210	03 (abcd/abcd)	03 (abcd/abcd)	03 (abcd/abcd)	03 (abcd/abcd)	03 (abcd/abcd)	03 (abcd/abcd)
Codabar Start Stop Character Match on page 211	00 (disable)	00 (disable)	00 (disable)	00 (disable)	00 (disable)	00 (disable)
Codabar Check Character Calculation on page 212	00 (disable)	00 (disable)	00 (disable)	00 (disable)	00 (disable)	00 (disable)
Codabar Check Character Transmission on page 213	01 (enable)	01 (enable)	01 (enable)	01 (enable)	01 (enable)	01 (enable)
Codabar Minimum Read on page 214	01 (1 read)	01 (1 read)	01 (1 read)	01 (1 read)	01 (1 read)	01 (1 read)
Codabar Correlation on page 215	00 (disable)	00 (disable)	00 (disable)	00 (disable)	00 (disable)	00 (disable)
Codabar Length Control on page 216	00 (variable)	00 (variable)	00 (variable)	00 (variable)	00 (variable)	00 (variable)
Codabar Length 1 on page 217	03	03	03	03	03	03
Codabar Length 2 on page 218	32	32	32	32	32	32
Codabar Stitching on page 219	00 (disable)	00 (disable)	00 (disable)	00 (disable)	00 (disable)	00 (disable)
Codabar Require Margins on page 220	00 (disable)	00 (disable)	00 (disable)	00 (disable)	00 (disable)	00 (disable)
Code 93 on page 221	00 (disable)	00 (disable)	00 (disable)	00 (disable)	00 (disable)	00 (disable)
Code 93 Minimum Read on page 222	01 (1 read)	01 (1 read)	01 (1 read)	01 (1 read)	01 (1 read)	01 (1 read)
Code 93 Correlation on page 223	00 (disable)	00 (disable)	00 (disable)	00 (disable)	00 (disable)	00 (disable)
Code 93 Length Control on page 224	00 (variable)	00 (variable)	00 (variable)	00 (variable)	00 (variable)	00 (variable)

Feature	Default Master	RS-232	RS-232 Wincor-Nixdorf	Keyboard	USB COM / USB TEC	USB OEM
Code 93 Length 1 on page 225	01	01	01	01	01	01
Code 93 Length 2 on page 226	32	32	32	32	32	32
Code 93 Stitching on page 227	01 (enable)	01 (enable)	01 (enable)	01 (enable)	01 (enable)	01 (enable)
MSI on page 228	00 (disable)	00 (disable)	00 (disable)	00 (disable)	00 (disable)	
MSI Check Character Calculation on page 229	01 (enable)	01 (enable)	01 (enable)	01 (enable)	01 (enable)	
MSI Number of Check Characters on page 230	00 (1 char)	00 (1 char)	00 (1 char)	00 (1 char)	00 (1 char)	
MSI Check Character Transmission on page 231	01 (enable)	01 (enable)	01 (enable)	01 (enable)	01 (enable)	
MSI Minimum Read on page 232	01 (1 read)	01 (1 read)	01 (1 read)	01 (1 read)	01 (1 read)	
MSI Correlation on page 233	00 (disable)	00 (disable)	00 (disable)	00 (disable)	00 (disable)	
MSI Length Control on page 234	00 (variable)	00 (variable)	00 (variable)	00 (variable)	00 (variable)	
MSI Length 1 on page 235	04	04	04	04	04	
MSI Length 2 on page 236	10	10	10	10	10	
MSI Stitching on page 237	00 (disable)	00 (disable)	00 (disable)	00 (disable)	00 (disable)	
Standard 2 of 5 on page 238	00 (disable)	00 (disable)	00 (disable)	00 (disable)	00 (disable)	00 (disable)
Standard 2 of 5 Check Character Calculation on page 239	00 (disable)	00 (disable)	00 (disable)	00 (disable)	00 (disable)	00 (disable)
Standard 2 of 5 Check Character Transmission on page 240	01 (enable)	01 (enable)	01 (enable)	01 (enable)	01 (enable)	01 (enable)
Standard 2 of 5 Minimum Read on page 241	01 (1 read)	01 (1 read)	01 (1 read)	01 (1 read)	01 (1 read)	01 (1 read)
Standard 2 of 5 Correlation on page 242	00 (disable)	00 (disable)	00 (disable)	00 (disable)	00 (disable)	00 (disable)

Feature	Default Master	RS-232	RS-232 Wincor-Nixdorf	Keyboard	USB COM / USB TEC	USB OEM
Standard 2 of 5 Length Control on page 243	00 (variable)	00 (variable)	00 (variable)	00 (variable)	00 (variable)	00 (variable)
Standard 2 of 5 Length 1 on page 244	08	08	08	08	08	08
Standard 2 of 5 Length 2 on page 245	32	32	32	32	32	32
Standard 2 of 5 Stitching on page 246	00 (disable)	00 (disable)	00 (disable)	00 (disable)	00 (disable)	00 (disable)
2D Symbology Programming						
Data Matrix on page 248	00 (disable)	00 (disable)	00 (disable)	00 (disable)	00 (disable)	00 (disable)
Data Matrix Length Control on page 249	00 (variable)	00 (variable)	00 (variable)	00 (variable)	00 (variable)	00 (variable)
Set Data Matrix Length 1 on page 250	0001	0001	0001	0001	0001	0001
Set Data Matrix Length 2 on page 250	0320	0320	0320	0320	0320	0320
GS1 Datamatrix Enable on page 251	00 (transmit as std Data-matrix label)	00 (transmit as std Data-matrix label)	01 (transmit as GS1 Data-matrix label)	00 (transmit as std Data-matrix label)	00 (transmit as std Data-matrix label)	00 (transmit as std Data-matrix label)
PDF 417 Enable on page 252	00 (disable)	00 (disable)	00 (disable)	00 (disable)	00 (disable)	00 (disable)
PDF 417 Length Control on page 253	00 (variable)	00 (variable)	00 (variable)	00 (variable)	00 (variable)	00 (variable)
Set PDF 417 Length 1 on page 254	0001	0001	0001	0001	0001	0001
Set PDF 417 Length 2 on page 254	0A96	0A96	0A96	0A96	0A96	0A96
PDF 417 Read Option on page 255	00 (none)	00 (none)	00 (none)	00 (none)	00 (none)	00 (none)
Micro PDF 417 on page 256	00 (disable)	00 (disable)	00 (disable)	00 (disable)	00 (disable)	00 (disable)
Micro PDF 417 Length Control on page 257	00 (variable)	00 (variable)	00 (variable)	00 (variable)	00 (variable)	00 (variable)
Set Micro PDF 417 Length 1 on page 258	0001	0001	0001	0001	0001	0001
Set Micro PDF 417 Length 2 on page 258	016E	016E	016E	016E	016E	016E

Feature	Default Master	RS-232	RS-232 Wincor-Nixdorf	Keyboard	USB COM / USB TEC	USB OEM
Micro PDF 417 128 Emulation on page 259	00 (Micro PDF 417 AIM ID & label type)	00 (Micro PDF 417 AIM ID & label type)	00 (Micro PDF 417 AIM ID & label type)	00 (Micro PDF 417 AIM ID & label type)	00 (Micro PDF 417 AIM ID & label type)	00 (Micro PDF 417 AIM ID & label type)
QR Code on page 260	00 (disable)	00 (disable)	00 (disable)	00 (disable)	00 (disable)	00 (disable)
QR Code Length Control on page 261	00 (variable)	00 (variable)	00 (variable)	00 (variable)	00 (variable)	00 (variable)
Set QR Code Length 1 on page 262	0001	0001	0001	0001	0001	0001
Set QR Code Length 2 on page 262	0A96	0A96	0A96	0A96	0A96	0A96
QR Code URL Link Enable on page 263	00 (disable)	00 (disable)	00 (disable)	00 (disable)	00 (disable)	00 (disable)
GS1 QR Code Enable on page 264	00 (transmit as std QR Code label)	00 (transmit as std QR Code label)	01 (transmit as GS1 QR Code label)	00 (transmit as std QR Code label)	00 (transmit as std QR Code label)	00 (transmit as std QR Code label)
Micro QR Code on page 265	00 (disable)	00 (disable)	00 (disable)	00 (disable)	00 (disable)	00 (disable)
Micro QR Code Length Control on page 266	00 (variable)	00 (variable)	00 (variable)	00 (variable)	00 (variable)	00 (variable)
Set Micro QR Code Length 1 on page 267	0001	0001	0001	0001	0001	0001
Set Micro QR Code Length 2 on page 267	0E74	0E74	0E74	0E74	0E74	0E74
Aztec Code on page 268	00 (disable)	00 (disable)	00 (disable)	00 (disable)	00 (disable)	00 (disable)
Aztec Length Control on page 269	00 (variable)	00 (variable)	00 (variable)	00 (variable)	00 (variable)	00 (variable)
Set Aztec Length 1 on page 270	0001	0001	0001	0001	0001	0001
Set Aztec Length 2 on page 270	0E74	0E74	0E74	0E74	0E74	0E74



Appendix E

Keyboard Function Key Mappings

USB Function Key Usage Map

ASCII	Key value	Usage Name	Modifier/Scancode
02	STX	F11	00h 44h
03	ETX	F12	00h 45h
04	EOT	GUI right Make	80h 00h
05	ENQ	GUI right Break	00h 00h
06	ACK	CTRL right Make	10h 00h
07	BEL	CTRL right Break	00h 00h
08	BS	BS	00h 2Ah
09	HT	TAB right	00h 2Bh
0A	LF	RIGHT arrow (inner keypad)	00h 4Fh
0B	VT	TAB left	02h 2Bh
0C	FF	Enter (right keypad)	00h 58h
0D	CR	CR	00h 28h
0E	SO	INSERT (inner keypad)	00h 49h
0F	SI	PAGE UP (inner keypad)	00h 4Bh
10	DLE	PAGE DOWN (inner keypad)	00h 4Eh
11	DC1	HOME (inner keypad)	00h 4Ah
12	DC2	LEFT arrow (inner keypad)	00h 50h
13	DC3	DOWN arrow (inner keypad)	00h 51h
14	DC4	UP arrow (inner keypad)	00h 52h
15	NAK	F6	00h 3Fh
16	SYN	F1	00h 3Ah
17	ETB	F2	00h 3Bh
18	CAN	F3	00h 3Ch
19	EM	F4	00h 3Dh
1A	SUB	F5	00h 3Eh
1B	ESC	ESC	00h 29h
1C	FS	F7	00h 40h
1D	GS	F8	00h 41h
1E	RS	F9	00h 42h
1F	US	F10	00h 43h

The following keys can be optionally configured to correspond to the Rev C version of this function table. See "USB Keyboard Additional Interface Options" on page 86 to set this feature.

ASCII	Key value	Usage Name	Modifier/Scancode
02	STX	F11	00h 44h
03	ETX	F12	00h 45h
04	EOT	GUI right Make	80h 00h
05	ENQ	GUI right Break	00h 00h

Scanset 1 Function Key Map

ASCII (hex)	ASCII code	Key	Scancode
02	STX	ALT left Make	38h
03	ETX	ALT left Break	B8h
04	EOT	CTRL left Make	1Dh
05	ENQ	CTRL left Break	9Dh
06	ACK	CTRL right Make	E0h 1Dh
07	BEL	CTRL right Break	E0h 9Dh
08	BS	BS	0Eh
09	HT	TAB right	0Fh
0A	LF	RIGHT arrow (inner keypad)	4Dh + E0
0B	VT	TAB left	0Fh + S
0C	FF	Enter (inner keypad)	1Ch + E0
0D	CR	CR	1Ch
0E	SO	INSERT (inner keypad)	52h + E0
0F	SI	PAGE UP (inner keypad)	49h + E0
10	DLE	PAGE DOWN (inner keypad)	51h + E0
11	DC1	HOME (inner keypad)	47h + E0
12	DC2	LEFT arrow (inner keypad)	4Bh + E0
13	DC3	DOWN arrow (inner keypad)	50h + E0
14	DC4	UP arrow (inner keypad)	48h + E0

Scanset 2 Function Key Map

ASCII (hex)	ASCII code	Key	Scancode
02	STX	ALT left Make	11h
03	ETX	ALT left Break	F0h 11h
04	EOT	CTRL left Make	14h
05	ENQ	CTRL left Break	F0h 14h
06	ACK	CTRL right Make	E0h 14h
07	BEL	CTRL right Break	E0h F0h 14h
08	BS	BS	66h
09	HT	TAB right	0Dh
0A	LF	RIGHT arrow (inner keypad)	74h + E0
0B	VT	TAB left	0Dh + S
0C	FF	Enter (right keypad)	5Ah + E0
0D	CR	CR	5Ah
0E	SO	INSERT (inner keypad)	70h + E0
0F	SI	PAGE UP (inner keypad)	7Dh + E0
10	DLE	PAGE DOWN (inner keypad)	7Ah + E0
11	DC1	HOME (inner keypad)	6Ch + E0
12	DC2	LEFT arrow (inner keypad)	6Bh + E0
13	DC3	DOWN arrow (inner keypad)	72h + E0
14	DC4	UP arrow (inner keypad)	75h + E0
15	NAK	F6	0Bh
16	SYN	F1	05h
17	ETB	F2	06h
18	CAN	F3	04h
19	EM	F4	0Ch
1A	SUB	F5	03h
1B	ESC	ESC	76h
1C	FS	F7	83h

1D	GS	F8	0Ah
1E	RS	F9	01h
1F	US	F10	09h

Scanset 3, 102-Key Function Key Map

ASCII (hex)	ASCII code	Key	Scancode
02	STX	ALT left Make	19h
03	ETX	ALT left Break	F0h 19h
04	EOT	CTRL left Make	11h
05	ENQ	CTRL left Break	F0h 11h
06	ACK	CTRL right Make	58h
07	BEL	CTRL right Break	F0h 58h
08	BS	BS	66h
09	HT	TAB right	0Dh
0A	LF	RIGHT arrow (inner keypad)	6Ah
0B	VT	TAB left	0Dh + S
0C	FF	Enter (inner keypad)	79h
0D	CR	CR	5Ah
0E	SO	INSERT (inner keypad)	67h
0F	SI	PAGE UP (inner keypad)	6Fh
10	DLE	PAGE DOWN (inner keypad)	6Dh
11	DC1	HOME (inner keypad)	6Eh
12	DC2	LEFT arrow (inner keypad)	61h
13	DC3	DOWN arrow (inner keypad)	60h
14	DC4	UP arrow (inner keypad)	63h
15	NAK	F6	2Fh
16	SYN	F1	07h
17	ETB	F2	0Fh
18	CAN	F3	17h
19	EM	F4	1Fh
1A	SUB	F5	27h
1B	ESC	ESC	08h
1C	FS	F7	37h
1D	GS	F8	3Fh
1E	RS	F9	47h
1F	US	F10	4Fh

Scanset 3 122-Key Function Key Map

ASCII (hex)	ASCII code	Key	Scancode
02	STX	ALT left Make	19h
03	ETX	ALT left Break	F0h 19h
04	EOT	CTRL left (RESET) Make only	11h
05	ENQ	CTRL left (RESET) Make/Break	11h F0h 11h
06	ACK	ONLINE Enter Make only	58h
07	BEL	ONLINE Enter Make/Break	58h F0h 58h
08	BS	BS	66h
09	HT	TAB right	0Dh
0A	LF	RIGHT arrow (inner keypad)	6Ah
0B	VT	TAB left	0Dh + S
0C	FF	CR (FIELD EXIT) Make only	5Ah F0h 5Ah
0D	CR	CR (FIELD EXIT) Make/Break	5Ah
0E	SO	INSERT (inner keypad)	65h
0F	SI	FIELD +	79h
10	DLE	FIELD -	7Ch
11	DC1	HOME (inner keypad)	62h
12	DC2	LEFT arrow (inner keypad)	61h
13	DC3	DOWN arrow (inner keypad)	60h
14	DC4	UP arrow (inner keypad)	63h
15	NAK	F6	2Fh
16	SYN	F1	07h
17	ETB	F2	0Fh
18	CAN	F3	17h
19	EM	F4	1Fh
1A	SUB	F5	27h
1B	ESC	ESC	08h
1C	FS	F7	37h
1D	GS	F8	3Fh
1E	RS	F9	47h
1F	US	F10	4Fh

Japanese DOS Function Key Map

ASCII value	ASCII code	Key	Scancode
02h	STX	ALT left Make	31h
03h	ETX	ALT left Break	B1h
04h	EOT	CTRL left Make	41h
05h	ENQ	CTRL left Break	C1h
06h	ACK	CTRL right Make	41h
07h	BEL	CTRL right Break	C1h
08h	BS	BS	3Eh
09h	HT	TAB right	3Ch
0Ah	LF	RIGHT arrow (inner keypad)	4Dh
0Bh	VT	TAB left	3Ch + S
0Ch	FF	Enter (right keypad)	60h
0Dh	CR	CR	3Bh
0Eh	SO	INSERT (inner keypad)	52h
0Fh	SI	PAGE UP (inner keypad)	49h
10h	DLE	PAGE DOWN (inner keypad)	51h
11h	DC1	HOME (inner keypad)	4Ch
12h	DC2	LEFT arrow (inner keypad)	4Bh
13h	DC3	DOWN arrow (inner keypad)	4Ah
14h	DC4	UP arrow (inner keypad)	4Eh
15h	NAK	F6	6Dh
16h	SYN	F1	68h
17h	ETB	F2	69h
18h	CAN	F3	6Ah
19h	EM	F4	6Bh
1Ah	SUB	F5	6Ch
1Bh	ESC	ESC	3Dh
1Ch	FS	F7	6Eh
1Dh	GS	F8	6Fh
1Eh	RS	F9	70h
1Fh	US	F10	71h

NEC 9801-Key Function Key Map

ASCII value	ASCII code	Key	Scancode
00h	NUL	unused	n/a
01h	SOH	CR	1Ch
02h	STX	CAPS LOCK ON (make)	71h
03h	ETX	CAPS LOCK OFF (break)	F1h
04h	EOT	CTRL left Make	74h
05h	ENQ	CTRL left Break	F4h
06h	ACK	CTRL-C	60h
07h	BEL	n/a	n/a
08h	BS	BS	0Eh
09h	HT	TAB right	0Fh
0Ah	LF	RIGHT arrow (inner keypad)	3Ch
0Bh	VT	TAB left	0Fh + S
0Ch	FF	DELETE	39h
0Dh	CR	CR	1Ch
0Eh	SO	INSERT (inner keypad)	38h
0Fh	SI	KATAKANA LOCK ON (Make)	72h
10h	DLE	KATAKANA LOCK OFF (Break)	F2h
11h	DC1	HOME (inner keypad)	3Eh
12h	DC2	LEFT arrow (inner keypad)	3Bh
13h	DC3	DOWN arrow (inner keypad)	3Dh
14h	DC4	UP arrow (inner keypad)	3Ah
15h	NAK	F6	67h
16h	SYN	F1	62h
17h	ETB	F2	63h
18h	CAN	F3	64h
19h	EM	F4	65h
1Ah	SUB	F5	66h
1Bh	ESC	ESC	00h
1Ch	FS	F7	68h
1Dh	GS	F8	69h
1Eh	RS	F9	6Ah
1Fh	US	F10	6Bh



Appendix F

Host Commands

Accepting RS-232 Commands

The scanner responds to the following RS-232 commands:

COMMAND	ASCII	HEX	COMMENT
Enable Scanner	E	0x45	
Disable Scanner	D	0x44	
Reset Scanner	R	0x52	
Not On File Indication	F	0x46	Long series of beeps
Beep Good Read Tone	B	0x42	Beeps if Good Read Beep is enabled
Force Good Read Tone	!	0x01	Beeps regardless of beep setting
Identification request	i	0x69	Returns long response ^a
Health request	h	0x68	Returns long response ^a
Status request	s	0x73	Returns long response ^a
Beep on ASCII BEL	!	0x07	Beeps if Beep on ASCII BEL is enabled

a. Call Tech Support for information.

If one of the above commands is received, the scanner will perform the steps indicated for the command. Host commands for other interfaces are also available. Contact Tech Support for more details.

Also see the section "[Image Capture to the Host by Host Command](#)" on page 90 for details concerning that feature.



Appendix G

Sample Symbols

1D Symbol Samples

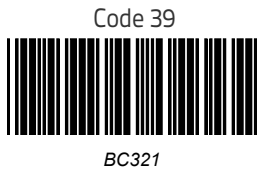
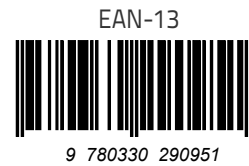
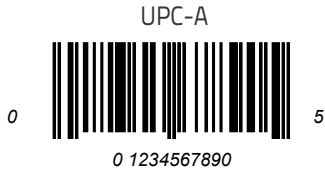

1D Symbols (continued)

Code 2 of 5

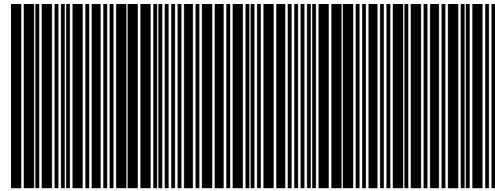

123456

GS1 DataBar Omnidirectional



(01)00123456789012

GS1 DataBar Expanded



0100123456789050

GS1 DataBar Limited

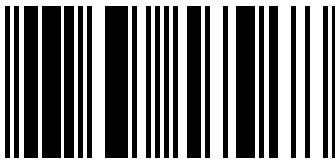

(01)16543210987654

2D Sample Symbols

PDF 417

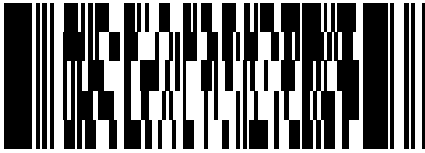

A12B3C

Micro PDF 417



BV17453

Datamatrix

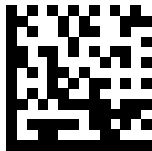

1314H17LL

QR Code

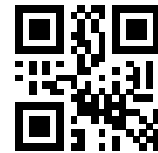

35900G9

Micro QR Code



ABCDEF

Aztec



This is an Aztec Code

Composite Sample Symbols

GS1 DataBar Limited Composite

(17) 050923 (10) ABC123



(01) 0 4012345 67890 1

GS1 DataBar Truncated Composite

(17)050923(10)ABC123



(01) 09876543217899



Appendix H microSD Card

MICROSDHC COMPATIBILITY starting on page 311 <ul style="list-style-type: none">•microSD Card Insertion on page 311•microSD Card Removal on page 312
AUTORUN FILE PROCESSING starting on page 312
MICROSD FUNCTION SUMMARY starting on page 312
MICROSD FUNCTION DETAILS starting on page 313 <ul style="list-style-type: none">•From Scanner to microSD Card on page 313•From microSD Card to Scanner on page 314

microSDHC Compatibility

At the time of this writing, the microSD card interface for this product supports SD–Memory Card Specifications/ Part 1. Physical Layer Specification; Version 1.01, but the processor MCI can communicate with SDHC Cards. For example, the scanner can perform the functions specified in this appendix for the SDA 2.0 specification. Both FAT16 and FAT32 formats are supported.

Filenames are limited to the 8.3 file naming format (i.e., **FILENAME.EXT**), and **MUST** be capitalized.

microSD Card Insertion

1. Read all of these instructions before starting.
2. If you have not already done so, remove the scanner from its installed position to allow access to the microSD card slot.
3. Separate the scanner from its back cover.
4. Ensure there are no other cables attached to the scanner, then apply power and wait for the reset beep.
5. Lift and rotate the rubber cover to access the card slot, then carefully insert the microSD card into the slot until it "clicks" into place.

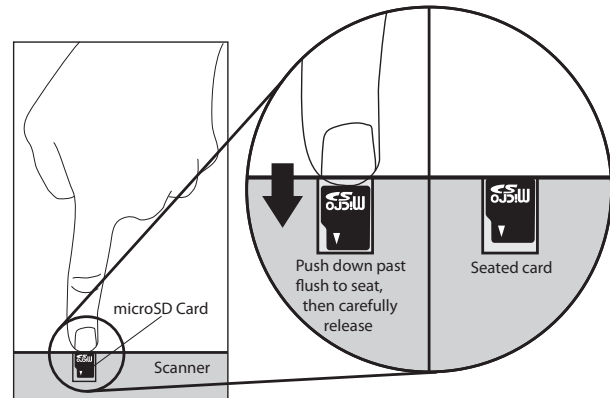

CAUTION

The microSD card slot is spring loaded. Keep your finger lightly in place atop the card until you are sure it is fully seated in place. See the illustration on the following page.

Use your finger or thumbnail to push in on the top edge of the card to be slightly below flush with the scanner enclosure when inserting or removing the card. This will engage/disengage the spring mechanism.

Never insert tools or other foreign objects into the microSD card slot.

6. If installed properly, you should immediately hear an audible signal upon insertion or removal of a microSD card. Various operations will also be indicated by the scanner's good read LED.

microSD Card Removal

1. Push in gently using your finger or thumbnail to disengage and remove the microSD card. Remember to keep your finger in place atop the card's edge to avoid accidentally "launching" the card from the spring-loaded slot.
2. Reconnect all cables which were disconnected earlier.

Aurun File Processing

After insertion of the card, the scanner will mount the microSD card and search for the file "AUTORUN.DLS". Embedded in that file is a validation pattern of the ASCII strings "\$START\$" and "\$END\$" located at the respective starting and ending of the file.

If the validation pattern is found, the file may contain any of the following commands. The scanner will parse the file taking action according to these commands. Filenames in **this format** specify a user-defined name.

Example AUTORUN.DLS file:

```
$START$ (required)
CONFIG, FILENAME . TEX
DUMPSTATS, FILENAME . TXT
DUMPCFG, FILENAME . TEX
LOADSW, FILENAME . S37
$END$ (required)
```

microSD Function Summary

The following table summarizes various functions of microSD card. Contact tech support regarding upgrade license for new features.

FUNCTION		Export Status	Export Configuration	Load Applic	Load Config	Load CPLD Code ^a	Feature Upgrade ^b
Direction	Scanner ⇒ microSD Card	√	√				
	microSD Card ⇒ Scanner			√	√	√	√
Initiated by	Scanning a label			√	√		
	AUTORUN.DLS file in microSD card	√	√	√	√	√	√

a. The only way to load CPLD code (i.e., FPGA code) is to load a new application package.

b. The only way to do a feature upgrade is to load a new application package.

microSD Function Details

From Scanner to microSD Card

Capture and save an image to a microSD card by button press

1. Insert the secure microSD card into the scanner.
2. Place the item to be captured in front of the scanner.
3. Press and release the Camera Button for one second. The scanner will automatically capture and save the image to the microSD card.
4. The scanner will emit an audible signal when complete, and the image is saved to the microSD card.



NOTE

The microSD card must contain a secure file to save images. Contact Customer Support for more details about this feature.

The image file name range is from image-1 to image-999. If the same name already exists in the microSD card, the scanner skips that name and uses the next.

Image format (.BMP, .JPG), image size (VGA, WVGA, Full size), Brightness (0~9), contrast (0~9), and JPG compression ratio (0~100) are defined in configuration.

Export a Configuration file from the Scanner to the microSD card

By AUTORUN.DLS file

1. Generate a text file by any text editor as follows and save it as **AUTORUN.DLS**.

```
$START$
DUMPCFG,SDCONFIG.TEX (Filename can be anything, for example
"SOMETHING.TEX")
$END$
```
2. Save or copy file AUTORUN.DLS to microSD card
3. Insert the microSD card to scanner.
4. Wait for 3 seconds,

A scanner configuration file named **SDCONFIG.TXT** is saved to the microSD card.

From microSD Card to Scanner

Application code load to scanner

By AUTORUN.DLS file

1. Generate a text file by any text editor as follows and save it as **AUTORUN.DLS**

```
$START$  
LOADSW,R96-APP1.S37  
$END$
```
2. Save or copy file **AUTORUN.DLS** to microSD card and copy the application code (example **R96-APP1.S37**) to the microSD card.
3. Insert the microSD card into the scanner.
4. Upon scanner audio indication of completion, the application code **R96-APP1.S37** is loaded to the scanner. Typically, this takes about 45 seconds.

Configuration load to scanner

By Autorun file

1. Generate a text file by any text editor as follows and save it as **AUTORUN.DLS**

```
$START$  
CONFIG,R96-CFG1.TEX  
$END$
```
2. Save or copy the autorun.dls file, and copy the CPLD code (example **R96-CFG1.TEX**) to the microSD card.
3. Insert the microSD card into the scanner.
4. Upon scanner audio indication of completion, configuration **R96-CFG1.TEX** is loaded to the scanner.



Appendix I

Handheld Data Format Requirements

This appendix provides application notes to describe the general format of data that can be accepted by the scanner from a handheld scanner connected via the USB port.

Handheld Data Format Requirements General

- USB handhelds enumerate as a CDC ACM serial device.
- USB devices should also bracket the data with the RTS equivalent.
- The time between character transmission can be no longer than 50 milliseconds.
- Symbologies requiring fixed lengths (UPC/EAN) will enforce length requirements for validation of the label.
- Handheld will be required to transmit start and stop characters for Codabar and Code39 labels.
- Appropriate industrial length requirements will be enforced (if configured) for validation of the label.
- Maximum label lengths will be enforced for label validation (i.e. labels longer than the maximum label size will not be validated).
- Standard Datalogic formats generally use a single prefix character. see specific formats section.
- Maximum label size allowed including identifiers is 2714 bytes
- Recommendations:
 - Handheld should not be configured for audible label read indication.
 - Handheld should not be configured for visual label read indication.
 - Handheld should not be configured for continuous label read mode.

Datalogic Handheld Data Format Requirements

The following sections describe label transmission formats that are typically observed in factory configurations of Datalogic handheld scanners.

GS1 DataBar Omnidirectional

- Prefix must be ASCII characters 'R4'
- Check character must be included in label
- Application identifier "01" must follow the prefix and precede the base label
- Label length excluding prefix characters must be 16 characters.
- Example: 'R40101044123456789'

GS1 DataBar Expanded

- Prefix must be ASCII characters 'R4'
- Check character must be included in label

UPC-A

- Number system must be included in label data.
- Check digit must be included in label data and is assumed to be correct.
- Prefix must be an ASCII character 'A' – total length including prefix must be 13.
- Example: 'A060992011187'.

UPC-A with 2-Digit Supplemental

- Number system must be included in label data.
- Check digit must be included in label data and is assumed to be correct.
- Supplemental data is appended to base label.
- Prefix must be an ASCII character 'A' – total length including prefix must be 15.
- Example: 'A06099201118712'.

UPC-A with 5-Digit Supplemental

- Number system must be included in label data
- Check digit must be included in label data and is assumed to be correct
- Prefix must be an ASCII character 'A' – total length including prefix must be 18
- Example: 'A06099201118712345'

UPC-E

- Number system must be included in label data
- Check digit must be included in label data and is assumed to be correct
- Prefix must be an ASCII character 'E' – total length including prefix must be 9
- Example: 'E09988750'

UPC-E with 2-Digit Supplemental

- Number system must be included in label data.
- Check digit must be included in label data and is assumed to be correct.
- Supplemental data is appended to base label.
- Prefix must be an ASCII character 'E' – total length including prefix must be 11.
- Example: 'E0998875012'.

UPC-E with 5-Digit Supplemental

- Number system must be included in label data.
- Check digit must be included in label data and is assumed to be correct.
- Prefix must be an ASCII character 'E' – total length including prefix must be 14.
- Example: 'E0998875012345'.

EAN-8

- Check digit must be included in label data and is assumed to be correct
- Prefix must be an ASCII characters 'FF' – total length including prefix must be 10
- Example: 'FF00210126'

EAN-8 with 2-Digit Supplemental

- Check digit must be included in label data and is assumed to be correct.
- Supplemental data is appended to base label.
- Prefix must be an ASCII characters 'FF' – total length including prefix must be 12.
- Example: 'FF0021012612'.

EAN-8 with 5-Digit Supplemental

- Check digit must be included in label data and is assumed to be correct.
- Prefix must be an ASCII characters 'FF' – total length including prefix must be 15.
- Example: 'FF0021012612345'.

EAN-13

- Check digit must be included in label data and is assumed to be correct
- Prefix must be an ASCII character 'F'– total length including prefix must be 14
- Example: 'F1101234567891'

EAN-13 with 2-Digit Supplemental

- Check digit must be included in label data and is assumed to be correct
- Supplemental data is appended to base label
- Prefix must be an ASCII character 'F'– total length including prefix must be 16
- Example: 'F110123456789112'

EAN-13 with 5-Digit Supplemental

- Check digit must be included in label data and is assumed to be correct.
- Prefix must be an ASCII character 'F'– total length including prefix must be 19.
- Example: 'F110123456789112345'.

Code 39

- Check character must be included in label data.
- Label length including start, stop and check characters and excluding prefix character must meet requirements imposed by the main scanner's fixed or variable label length control for this symbology type.
- Start and stop characters "*" must be included in label.
- Prefix must be an ASCII character '*'.
- Example : '**Code 39.TEST*'.

Code 39-Pharmacode

- Check character must be included in label data.
- Label length including start, stop and check characters and excluding prefix character must meet requirements imposed by the main scanner's fixed or variable label length control for this symbology type.
- Start and stop characters "*" must be included in label.
- Prefix must be an ASCII character 'p'.
- Example: 'p*123456789*'.

I 2 of 5

- Check character must be included in label data.
- Label length including check characters and excluding prefix character must meet requirements imposed by the main scanner's fixed or variable label length control for this symbology type.
- Prefix must be an ASCII character 'i'.
- Example: 'i0123456789'.

Codabar

- Check character must be included in label data.
- Label length including check character and excluding prefix character must meet requirements imposed by the main scanner's fixed or variable label length control for this symbology type.
- Prefix must be an ASCII character '%'.
- Start stop character sets must meet the matching requirement set forth by the scanner configuration item *Start/Stop Character Match*.
- Start stop character sets must be of the form ABCD/ABCD and must be included in the label.
- Example: '%s\$99.95s' (the lower case 's' at each end of the example is a placeholder for the start stop character set).

Code 128

- Prefix must be an ASCII character '#'.
- Label length excluding prefix character or function code 3 for Code 128 programming labels must meet requirements imposed by the main scanner's fixed or variable label length control for this symbology type.
- Function characters may be transmitted as a hexadecimal value 8x. Where x correlates to function characters 1 thru 4 as follows:
 - x80 = function code 1
 - x81 = function code 2
 - x82 = function code 3
 - x83 = function code 4
- For Code 128 programming labels the format is of the general form '#/82nnnnn/r' - /82 is hexadecimal 82 and /r is carriage return.
- Example: '#Code_128.Test'.

MSI

- Check character must be included in label data.
- Label length including check character and excluding prefix character must meet requirements imposed by the main scanner's fixed or variable label length control for this symbology type.

- Prefix must be an ASCII character '@'.
- Example: '@144769254'.

Code 93

- Prefix must be an ASCII character '&'.
- Label length excluding prefix character must meet requirements imposed by the main scanner's fixed or variable label length control for this symbology type.
- Example: '&Code93-test'.

PDF417

- Prefix must be an ASCII character 'P'.
- Label length excluding prefix character cannot exceed 300 characters. In addition to this, label length excluding prefix character must meet requirements imposed by the main scanner's fixed or variable label length control for this symbology type.

AIM Formats

AIM specifies a 3-character string that is attached as a prefix to the label data for transmission. Because AIM specifies one identifier for UPC-A, UPC-E and EAN-13 labels, UPC-A, UPC-E and EAN-13 will be received from the handheld and transmitted by the scanner as EAN-13. The ']' character must be the first character received in the label transmission from the handheld.

The following sections describe the prefix strings and identify what specific label characteristics can be supported.

UPC-A

- AIM does not specify UPC-A as a separate symbology using this transmission format – labels will be transmitted as EAN-13.
- Example: ']E00060992011187'.

UPC-E

- AIM does not specify UPC-E as a separate symbology using this transmission format – labels will be transmitted as EAN-13.
- Example: ']E00000000998875'.

EAN-13

- Check digit must be included in label data and is assumed to be correct.
- Prefix must be ASCII characters ']E0' – total length including prefix must be 16.
- Example: ']E01101234567891'.

EAN-8

- Check digit must be included in label data and is assumed to be correct.
- Prefix must be ASCII characters ']E4' – total length including prefix must be 11.
- Example: ']E400210126'.

2-Digit Supplemental

- Supplemental data is appended to any EAN base label.

- Prefix must be ASCII characters ']E1'.
- length of Supplemental data including prefix must be 5. Total required length is 21 for EAN-13 and 16 for EAN-8.
- Examples: add-on portion is highlighted data is underlined.

UPC-A 2-Digit add-on]E00060992011187]E1 <u>12</u> '
UPC-E 2-Digit add-on]E00000000998875]E1 <u>12</u> '
EAN-8 2-Digit add-on]E400210126]E1 <u>12</u> '
EAN-13 2-Digit add-on]E01101234567891]E1 <u>12</u> '

5-Digit Supplemental

- Supplemental data is appended to any EAN base label.
- Prefix must be ASCII characters ']E2'.
- Length of supplemental data including prefix must be 8. Total required length is 24 for EAN-13 and 19 for EAN-8.
- Examples: add-on portion is highlighted data is underlined.

UPC-A 5-Digit add-on]E00060992011187]E2 <u>12345</u> '
UPC-E 5-Digit add-on]E00000000998875]E2 <u>12345</u> '
EAN-8 5-Digit add-on]E400210126]E2 <u>12345</u> '
EAN-13 5-Digit add-on]E01101234567891]E2 <u>12345</u> '

Bookland

- The 'Bookland' / ISBN code will be formatted as a vendor specific AIM label.
- Prefix must be ASCII characters ']X0'.
- length of label data including prefix is 13.
- Examples: ']X01234567890'.

Code 39

- Check character must be included in label data.
- Label length including start, stop and check characters and excluding prefix characters must meet requirements imposed by the main scanner's fixed or variable label length control for this symbology type.
- Start and stop characters "*" must be included in label.
- Prefix must be ASCII characters ']A0' or ']A1'.
- Example: '*]A0Code 39.TEST*'.

Codabar

- Check character must be included in label data.
- Label length including check character and excluding prefix characters must meet requirements imposed by the main scanner's fixed or variable label length control for this symbology type.
- Prefix must be ASCII characters ']F0'.
- Start stop character sets must meet the matching requirement set forth by the scanner configuration item *Start/Stop Character Match*.

- Start stop character sets `s` must be of the form ABCD/ABCD and must be included in the label.
- Example: 'JF0s\$99.95s' (the lower case 's' at each end of the example is a placeholder for the start stop character set).

MSI

- Check character must be included in label data.
- Label length including check character and excluding prefix characters must meet requirements imposed by the main scanner's fixed or variable label length control for this symbology type.
- Prefix must be ASCII characters 'JM0'.
- Example: 'JM0144769254'.

Code 93

- Prefix must be ASCII characters 'JG0'.
- Label length excluding prefix characters must meet requirements imposed by the main scanner's fixed or variable label length control for this symbology type.
- Example : 'JG0Code93-test'.

RSS-14

- Prefix must be ASCII characters 'je0'.
- Check character must be included in label.
- Label length excluding prefix characters must be 14 characters.
- Example: 'je001044123456789'.

RSS Expanded

- Prefix must be ASCII characters 'je0'.
- Label length excluding prefix characters must be at least 1 character. Maximum length is the maximum label size supported by the scanner.
- Example: 'je001900123456789083103001750'.

I 2 of 5

- Check character must be included in label data.
- Label length including check characters and excluding prefix characters must meet requirements imposed by the main scanner's fixed or variable label length control for this symbology type.
- Prefix must be an ASCII character 'J11' (other prefixes specify different check character properties which are not supported).
- Example: 'J110123456789'.

Code 128 / EAN128

- Prefix must be either ASCII characters 'JC0', 'JC1' or 'JC2'.
- Label length excluding prefix character must meet requirements imposed by the main scanner's fixed or variable label length control for this symbology type.
- If EAN-128 Symbology is Enabled and prefix is 'JC1', label will be identified as an EAN128 otherwise it is identified as a Code 128.
- A prefix of 'JC0' designates that no function code is present in the 1st or 2nd character position.

- A prefix of ']C2' designates that a function code 1 is present in the 2nd character.
- Example : ']C0Code_128.Test'.

PDF417

- Prefix must be an ASCII characters ']L0'.
- Label length excluding prefix character cannot exceed 300 characters. In addition to this, label length excluding prefix character must meet requirements imposed by the main scanner's fixed or variable label length control for this symbology type.
- Example : ']L0pdf_test_label'.

"Unknown" AIM ID (an AIM ID which is not specified above)

If a label is received that does not have an AIM ID as specified above, and the first three label characters qualify as follows...

- The first character is a ']'
- The second character is a capital or small letter
- The third character is a digit

...then the label type is set to GENERIC_DATA and the "unknown" AIM ID is left-appended to the beginning of the label data.

ASCII Character Set

The table on this page shows a set of ASCII characters and their corresponding Hex Values. The Hex Values in this table are needed for setting symbology specific label identifiers, as well as enabling custom prefix and suffix characters.

ASCII Char.	Hex No.	ASCII Char.	Hex No.	ASCII Char.	Hex No.	ASCII Char.	Hex No.
NUL	00	SP	20	@	40	'	60
SOH	01	!	21	A	41	a	61
STX	02	"	22	B	42	b	62
ETX	03	#	23	C	43	c	63
EOT	04	\$	24	D	44	d	64
ENQ	05	%	25	E	45	e	65
ACK	06	&	26	F	46	f	66
BEL	07	'	27	G	47	g	67
BS	08	(28	H	48	h	68
HT	09)	29	I	49	i	69
LF	0A	*	2A	J	4A	j	6A
VT	0B	+	2B	K	4B	k	6B
FF	0C	,	2C	L	4C	l	6C
CR	0D	-	2D	M	4D	m	6D
SO	0E	.	2E	N	4E	n	6E
SI	0F	/	2F	O	4F	o	6F
DLE	10	0	30	P	50	p	70
DC1	11	1	31	Q	51	q	71
DC2	12	2	32	R	52	r	72
DC3	13	3	33	S	53	s	73
DC4	14	4	34	T	54	t	74
NAK	15	5	35	U	55	u	75
SYN	16	6	36	V	56	v	76
ETB	17	7	37	W	57	w	77
CAN	18	8	38	X	58	x	78
EM	19	9	39	Y	59	y	79
SUB	1A	:	3A	Z	5A	z	7A
ESC	1B	;	3B	[5B	{	7B
FS	1C	<	3C	\	5C		7C
GS	1D	=	3D]	5D	}	7D
RS	1E	>	3E	^	5E	~	7E
US	1F	?	3F	_	5F	DEL	7F



© 2016-2019 Datalogic S.p.A. and/or its affiliates ▪ All rights reserved. ▪
Without limiting the rights under copyright, no part of this documenta-
tion may be reproduced, stored in or introduced into a retrieval system,
or transmitted in any form or by any means, or for any purpose, without
the express written permission of Datalogic S.p.A. and/or its affiliates ▪
Datalogic and the Datalogic logo are registered trademarks of Datalogic
S.p.A. in many countries, including the U.S. and the E.U.



www.datalogic.com

Datalogic S.r.l.

Via S. Vitalino, 13 | 40012 Calderara di Reno | Bologna - Italy
Tel. +39 051 3147011 | Fax +39 051 3147205



820089114 (Rev. B) Mar 2019