



Newland AIDC
Scanning Made Simple



NLS-NVH220

Industrial Handheld Barcode Scanner

**User
Guide**

Disclaimer

Please read through the manual carefully before using the product and operate it according to the manual. It is advised that you should keep this manual for future reference.

Do not disassemble the device or remove the seal label from the device, doing so will void the product warranty provided by Fujian Newland Auto-ID Tech. Co., Ltd.

All pictures in this manual are for reference only and actual product may differ. Regarding to the product modification and update, Fujian Newland Auto-ID Tech. Co., Ltd. reserves the right to make changes to any software or hardware to improve reliability, function, or design at any time without notice. The information contained herein is subject to change without prior notice.

The products depicted in this manual may include software copyrighted by Fujian Newland Auto-ID Tech. Co., Ltd or third party. The user, corporation or individual, shall not duplicate, in whole or in part, distribute, modify, decompile, disassemble, decode, reverse engineer, rent, transfer or sublicense such software without prior written consent from the copyright holders.

This manual is copyrighted. No part of this publication may be reproduced, distributed or used in any form without written permission from Newland.

Fujian Newland Auto-ID Tech. Co., Ltd. reserves the right to make final interpretation of the statement above.

Revision History

Version	Description	Date
V1.0.0	Initial release. This Manual is based on the firmware NVH220-HD_V1.01.001.	June 19th, 2022

Table of Contents

Revision History	- 3 -
Table of Contents	- 4 -
Preface	1
Introduction	1
Chapter Description	1
Explanation of Icons	2
Chapter 1 Getting Started	3
Introduction	3
Features of the NVH220	3
Accessories	4
Unpacking	4
NVH220 Scanner	5
Dimensions of the Scanner (unit: mm)	5
Data Port	6
Connecting the NVH220 to a Host	7
Using USB Cable	8
Using RS-232 Cable	9
Power On, Power Off, Reboot	10
Maintenance	11
Scanning Instructions	11
Chapter 2 NSet	12
Introduction	12
Main Features	12
Chapter 3 System Settings	14
Introduction	14
Barcode Programming	14
Command Programming	14
NSet Programming	14
Programming Barcode/ Programming Command/Function	15
Use of Programming Command	16
Command Syntax	16
Query Commands	16
Responses	18

Examples	18
Use of Programming Barcode	19
Illumination	20
Illumination Color	20
Illumination Rotation Interval	21
Aiming	21
Good Read LED	23
Good Read LED Duration	24
Power On Beep	26
Good Read Beep	26
Good Read Beep Volume	28
Good Read Beep Duration	29
Good Read Beep Frequency	30
Number of Good Read Beeps	31
Good Read Beep Interval Time	32
Good Read Vibration	32
Good Read Vibration Duration	33
Scan Mode	33
One Reading Timeout	36
Reading Interval	36
Image Stabilization Timeout (Sense Mode)	37
Good Read Delay	37
Image Decoding Timeout	39
Scanning Preference	40
Sensitivity	41
Read Barcode On/Off	42
Decode Area	42
Image Flipping	47
Image Resize	48
Transmit Not Good Read Message	49
Edit NGR Message	49
Image Filter	50
Default Settings	50
Factory Defaults	50
Custom Defaults	51
Query Scanner Information	52
Query Product Name	52
Query Firmware Version	52

Query Decoder Version	53
Query Hardware Version	53
Query Serial Number	53
Query Manufacturing Date	53
Chapter 4 RS-232 Interface	55
Introduction	55
Baud Rate	56
Parity Check	57
Data Bit	59
Stop Bit	59
Hardware Auto Flow Control	60
Chapter 5 USB Interface	61
Introduction	61
USB HID Keyboard	62
USB Country Keyboard Types	63
Beep on Unknown Character	67
Emulate ALT+Keypad	68
Code Page	70
Unicode Encoding	73
Function Key Mapping	74
ASCII Function Key Mapping Table	75
ASCII Function Key Mapping Table (Continued)	76
Inter-Keystroke Delay	77
Caps Lock	77
Convert Case	78
Emulate Numeric Keypad	78
Polling Rate	82
USB CDC	84
USB HID-POS	84
Introduction	84
Access the Scanner with Your Program	85
Acquire Scanned Data	85
Send Command to the Scanner	85
VID/PID	86
Chapter 6 Symbologies	87
Introduction	87

Global Settings	87
Enable/Disable All Symbologies	87
Enable/Disable 1D Symbologies	88
Enable/Disable 2D Symbologies	88
Image Brightness Adaptation	90
1D Decoding Complexity	90
1D Inverse	91
Code 128	92
Restore Factory Defaults	92
Enable/Disable Code 128	92
Set Length Range for Code 128	93
EAN-8	94
Restore Factory Defaults	94
Enable/Disable EAN-8	94
Transmit Check Character	95
2-Digit Add-On Code	95
5-Digit Add-On Code	97
Add-On Code Required	97
Add-On Code Separator	98
Convert EAN-8 to EAN-13	98
EAN-13	100
Restore Factory Defaults	100
Enable/Disable EAN-13	100
Transmit Check Character	101
2-Digit Add-On Code	101
5-Digit Add-On Code	103
Add-On Code Required	103
Add-On Code Separator	104
EAN-13 Beginning with 290 Add-On Code Required	104
EAN-13 Beginning with 378/379 Add-On Code Required	105
EAN-13 Beginning with 414/419 Add-On Code Required	106
EAN-13 Beginning with 434/439 Add-On Code Required	106
EAN-13 Beginning with 977 Add-On Code Required	107
EAN-13 Beginning with 978 Add-On Code Required	108
EAN-13 Beginning with 979 Add-On Code Required	108
UPC-E	109
Restore Factory Defaults	109
Enable/Disable UPC-E	109

Transmit Check Character	111
2-Digit Add-On Code	111
5-Digit Add-On Code	112
Add-On Code Required	114
Add-On Code Separator	114
Transmit Preamble Character	116
Convert UPC-E to UPC-A	116
UPC-A	117
Restore Factory Defaults	117
Enable/Disable UPC-A	117
Transmit Check Character	118
2-Digit Add-On Code	118
5-Digit Add-On Code	120
Add-On Code Required	120
Add-On Code Separator	121
Transmit Preamble Character	121
Interleaved 2 of 5	123
Restore Factory Defaults	123
Enable/Disable Interleaved 2 of 5	123
Set Length Range for Interleaved 2 of 5	124
Check Character Verification	125
ITF-14	126
Restore Factory Defaults	126
Enable/Disable ITF-14	126
ITF-6	128
Restore Factory Defaults	128
Enable/Disable ITF-6	128
Matrix 2 of 5	130
Restore Factory Defaults	130
Enable/Disable Matrix 2 of 5	130
Set Length Range for Matrix 2 of 5	131
Check Character Verification	132
Code 39	134
Restore Factory Defaults	134
Enable/Disable Code 39	134
Set Length Range for Code 39	135
Check Character Verification	136
Transmit Start/Stop Character	138

Enable/Disable Code 39 Full ASCII	138
Codabar	139
Restore Factory Defaults	139
Enable/Disable Codabar	139
Set Length Range for Codabar	140
Check Character Verification	141
Start/Stop Character	143
Code 93	145
Restore Factory Defaults	145
Enable/Disable Code 93	145
Set Length Range for Code 93	146
Check Character Verification	147
GS1-128 (UCC/EAN-128)	149
Restore Factory Defaults	149
Enable/Disable GS1-128	149
AIM 128	150
Restore Factory Defaults	150
Enable/Disable AIM 128	150
Set Length Range for AIM 128	151
ISBT 128	152
Restore Factory Defaults	152
Enable/Disable ISBT 128	152
Code 11	153
Restore Factory Defaults	153
Enable/Disable Code 11	153
Set Length Range for Code 11	155
Check Character Verification	156
Transmit Check Character	158
ISBN	159
Restore Factory Defaults	159
Enable/Disable ISBN	159
Set ISBN Format	160
ISSN	161
Restore Factory Defaults	161
Enable/Disable ISSN	161
Industrial 2/5	162
Restore Factory Defaults	162
Enable/Disable Industrial 2/5	162

Set Length Range for Industrial 25	164
Check Character Verification	165
Standard 2/5	167
Restore Factory Defaults	167
Enable/Disable Standard 2/5	167
Set Length Range for Standard 25	168
Check Character Verification	169
COOP 25	171
Restore Factory Defaults	171
Enable/Disable COOP 25	171
Set Length Range for COOP 25	172
Check Character Verification	173
Deutsche 14	174
Restore Factory Defaults	174
Enable/Disable Deutsche 14	174
Deutsche 12	176
Restore Factory Defaults	176
Enable/Disable Deutsche 12	176
Plessey	178
Restore Factory Defaults	178
Enable/Disable Plessey	178
Set Length Range for Plessey	180
Check Character Verification	181
MSI-Plessey	183
Restore Factory Defaults	183
Enable/Disable MSI-Plessey	183
Set Length Range for MSI-Plessey	185
Check Character Verification	186
Transmit Check Character	187
QR Code	188
Restore Factory Defaults	188
Enable/Disable QR Code	188
Set Length Range for QR Code	189
QR Inverse	190
Character Encoding	190
QR ECI Output	191
QR Decoding Complexity	191
Continuous Code	192

Dot-peen Code	192
Mirror Code	193
QR Model 1	193
QR Model 2	194
Data Matrix	195
Restore Factory Defaults	195
Enable/Disable Data Matrix	195
Set Length Range for Data Matrix	197
Rectangular Barcode	198
Data Matrix Inverse	198
Character Encoding	200
Data Matrix ECI Output	200
ECC200	201
ECC0TO140	201
DM Decoding Complexity	202
Continuous Code	203
Dot-peen Code	203
Mirror Code	204
PDF417	205
Restore Factory Defaults	205
Enable/Disable PDF417	205
Set Length Range for PDF417	207
PDF417 Inverse	208
Character Encoding	208
Chapter 8 Prefix & Suffix	210
Introduction	210
Global Settings	211
Enable/Disable All Prefixes/Suffixes	211
Prefix Sequence	211
Custom Prefix	213
Enable/Disable Custom Prefix	213
Set Custom Prefix	213
AIM ID Prefix	214
Code ID Prefix	215
Restore All Default Code IDs	215
Modify Code ID	216
Custom Suffix	224

Enable/Disable Custom Suffix	224
Set Custom Suffix	224
Terminating Character Suffix	225
Enable/Disable Terminating Character Suffix	225
Set Terminating Character Suffix	225
Chapter 9 Batch Programming	227
Introduction	227
Create a Batch Command	228
Create a Batch Barcode	228
Use Batch Barcode	229
Appendix	230
Digit Barcodes	230
Save/Cancel Barcodes	233
Factory Defaults Table	234
AIM ID Table	241
Code ID Table	242
Symbology ID Number	243
ASCII Table	244

Preface

Introduction

This manual provides detailed instructions for setting up and using the NLS-NVH220 Industrial Handheld Barcode Scanner (hereinafter referred to as **“the NVH220”** or **“the scanner”**).

Chapter Description

<i>Chapter 1 Getting Started</i>	: Gives a general description of NVH220 scanner.
<i>Chapter 2 NSet</i>	: Introduces a useful tool you can use to set up NVH220 scanner and develop new applications.
<i>Chapter 3 System Settings</i>	: Introduces three configuration methods and describes how to configure general parameters of NVH220 scanner.
<i>Chapter 4 RS-232 Interface</i>	: Describes how to configure RS-232 communication parameters.
<i>Chapter 5 USB Interface</i>	: Describes how to configure USB communication parameters.
<i>Chapter 6 Symbologies</i>	: Lists all compatible symbologies and describes how to configure the relevant parameters.
<i>Chapter 7 Data Formatter</i>	: Explains how to customize scanned data with the data formatter.
<i>Chapter 8 Prefix & Suffix</i>	: Describes how to use prefix and suffix to customize scanned data.
<i>Chapter 9 Batch Programming</i>	: Explains how to integrate a complex programming task into a single barcode.
<i>Appendix</i>	: Provides factory defaults table and a bunch of frequently used programming barcodes.

Explanation of Icons



Tools

This icon indicates something relevant to this manual.



This icon indicates this information requires extra attention from the reader.



This icon indicates handy tips that can help you use or configure the scanner with ease.



This icon indicates practical examples that can help you to acquaint yourself with operations.

Chapter 1 Getting Started

Introduction

The NVH220 reads a 1D or 2D barcode by capturing its image. Adopting the advanced **UIMG**[®] technology independently developed by Newland Auto-ID Tech, it provides several scan modes, including Manual mode, Pulse mode, Aim mode, Continuous mode and Batch mode, tailored to different scanning needs.

An illustrated introduction to the NVH220 is included in this chapter. If you have a scanner at hand, make good use of it to develop a better understanding of this manual. This chapter is written for normal users, maintenance staff and software developers.

Features of the NVH220

- Excellent DPM Decoding Capability
- Advanced Illumination system
- Fast Intelligent Learning and Rich Scene Configuration
- High Protection Industrial Structure Design

Model description

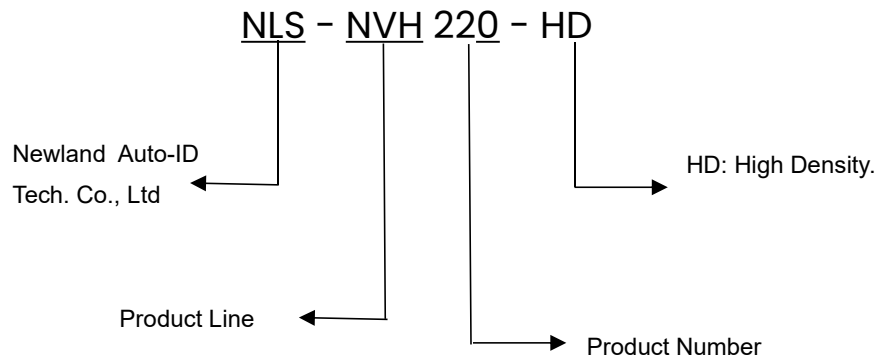

Accessories

Name	Specification	Number
NLS-NVH220 Scanner	NLS-NVH220	1
USB or RS232 Cable	RJ45 to USB or RS232	1
Power Adapter	Output: DC 5V,1.5A	1
Quick Guide	Paper	1
Qualification Certificate /Warranty Card	Paper	1

Unpacking

Open the package and take out the scanner and its accessories. Check to make sure everything on the packing list is present and intact. If any contents are damaged or missing, please keep the original package and contact your dealer immediately for after-sales service.

NVH220 Scanner

NVH220



Good Read/Network LED:

Red LED: Device is started successfully.

Green LED: Barcode is decoded successfully.

Dimensions of the Scanner (unit: mm)

NVH220

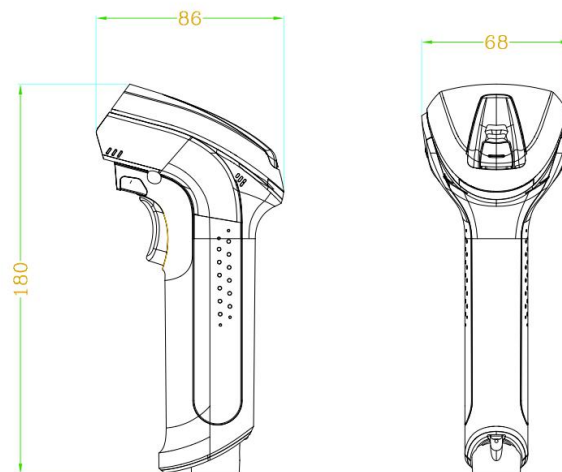

Data Port

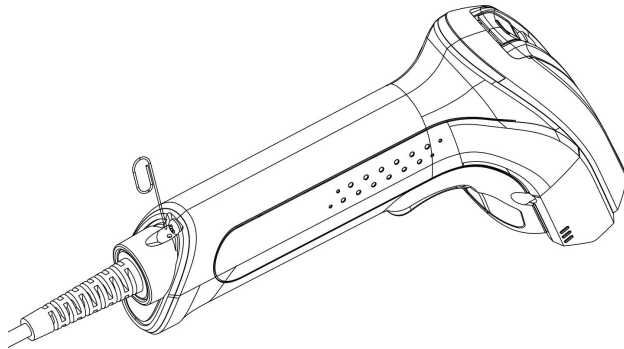

Data Port Pinout:

PIN	Signal	Type	Function
1	KB_CLK	I/O	Keyboard Clock Signal
2	KB_DATA	I/O	Keyboard Data Signal
3	VCC	P	Power, +5V
4	TXD	O	RS-232 Output
5	RXD	I	RS-232 Input
6	CTS	I	Clear To Send
7	RTS	O	Request To Send
8	GND	P	Ground
9	D-	I/O	USB Signal
10	D+	I/O	

Connecting the NVH220 to a Host

The scanner must be connected to a host device in actual application, such as PC, POS or any intelligent terminal with USB or RS-232, using a communication cable (USB or RS-232 cable).

USB

USB port on the host device



RS-232

RS-232 port on the host device



Using USB Cable

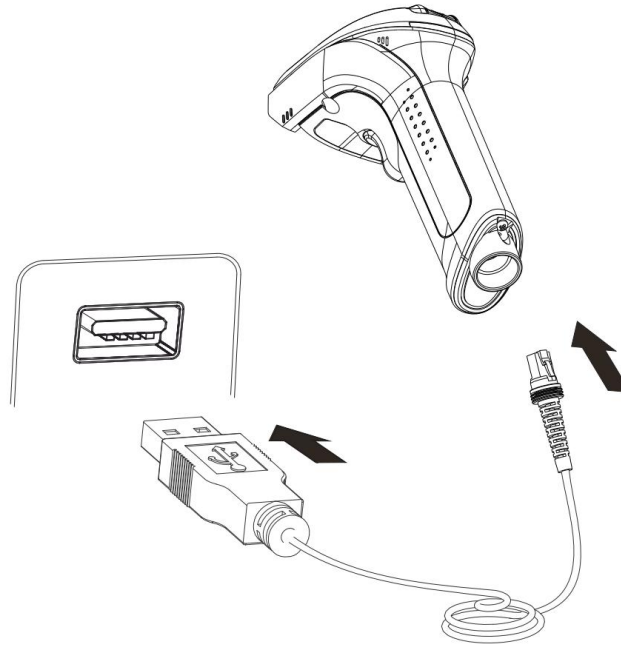

Connect the scanner to a host device through a USB cable with RJ45 and USB connectors:

1. Plug the RJ45 connector into the data port on the scanner.
2. Plug the USB connector into the USB port on the host device.

Using RS-232 Cable

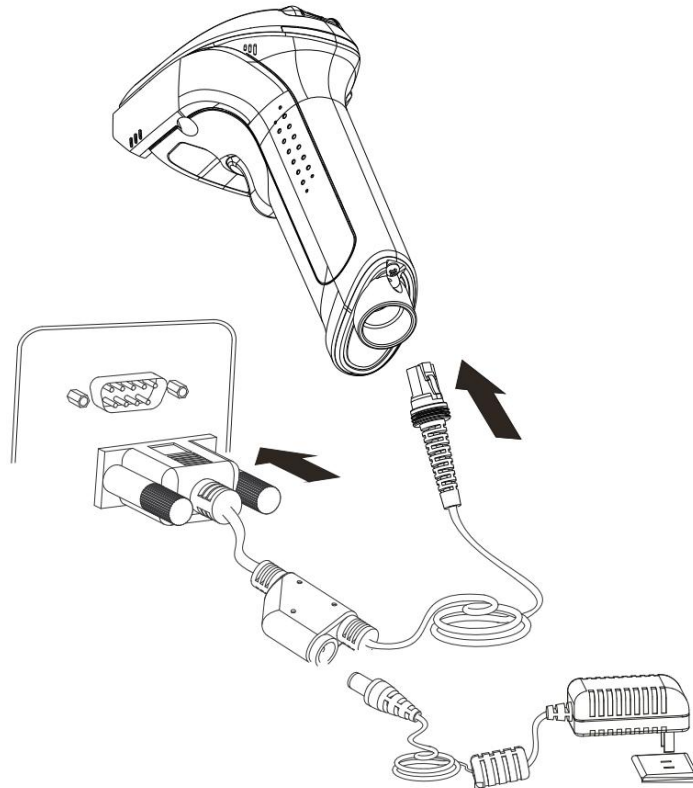

Connect the scanner to a host device through a RS-232 cable with RJ45 and RS-232 connectors and a power jack:

1. Plug the RJ45 connector into the data port on the scanner.
2. Plug the RS-232 connector into the RS-232 port on the host device.
3. Plug the supplied power adapter into the power jack on the RS-232 cable.

Power On, Power Off, Reboot

Power on the scanner

Connect the scanner to a host device. Then the scanner will be turned on and automatically enter the sleep mode.

Power off the scanner

Remove the cable from the scanner; or remove the cable from the host device; or disconnect the power adapter from mains.

Reboot the scanner

If the scanner stops responding to input or runs abnormally, turn off the scanner and then turn it back on.

Maintenance

- ✧ The scan window should be kept clean.
- ✧ Do not scratch the scan window.
- ✧ Use soft brush to remove the stain from the scan window.
- ✧ Use the soft cloth to clean the window, such as eyeglass cleaning cloth.
- ✧ Do not spray any liquid on the scan window.
- ✧ Do not use any detergent to clean other parts of the scanner except for water.



The warranty **DOES NOT** cover damages caused by inappropriate care and maintenance.

Scanning Instructions

When the scanner is in the Level scan mode, you can follow the steps below to scan a barcode:

1. Press and hold the trigger. Then the scanner will project a red cross focusing dashed line .
2. Center the aiming pattern on the barcode, as shown in the figure below.
3. Release the trigger when the aiming pattern goes off. If the barcode is decoded successfully, the scanner will emit a good read beep and the decoded data will be sent to the host device.

Note: For barcodes of the same batch, the scanner keeps a high success ratio in certain distance which is regarded as the optimal scanning distance.

Chapter 2 NSet

Introduction

NSet Setup Tool is a User Interface client application developed by Fujian Newland Auto-ID Tech. Co., Ltd. That simplifies initial reader setup and changing parameters of the scanners you use.

The NSet is a common platform across all models. It is installed in and runs on Windows-based PCs (usually laptops), and connection takes place through several different interface.

Main Features

- View and modify the information and setting parameters of online scanner.
- View the general configurations of the offline devices.
- Upgrade the firmware, compare the configurations, restore to the factory default ,etc in batch.
- Create/print/save setting barcodes to a PDF or Word file.
- Support to see how different options affect the reader in real time.
- Real-time refresh of device status.
- Support image playback.

Chapter 3 System Settings

Introduction

There are three ways to configure the NVH220: Barcode programming, command programming and NSet programming.

Barcode Programming

The NVH220 can be configured by scanning programming barcodes. All user programmable features/options are described along with their programming barcodes/commands in the following sections.

This programming method is most straightforward. However, it requires manually scanning barcodes. As a result, errors are more likely to occur.

Command Programming

The NVH220 can also be configured by serial commands (HEX) sent from the host device.

Users can design an application program to send those command strings to the scanners to perform device configuration.

NSet Programming

Besides the two methods mentioned above, you can conveniently perform scanner configuration through NSet too. NSet is a Windows-based configuration tool particularly designed for Newland products, enabling users to gain access to decoded data and captured images and to configure scanners. For more information about this tool, refer to the *NSet User Guide*.



Before programming the scanner, you need to pair it to a cradle first. When programming the scanner with serial commands or NSet, you need to insert it in the paired cradle.

Programming Barcode/ Programming Command/Function



The figure above is an example that shows you the programming barcode and command for the Level Mode function:

1. The **Level Mode** barcode.
2. The **Level Mode** command.
3. The description of feature/option.
4. ** indicates factory default settings.

Note: "@" included in the programming command indicates permanent setting which means the setting will not be lost by removing power from the scanner or turning off or rebooting it; whereas "#" included in the programming command indicates temporary setting which means the setting will be lost by removing power from the scanner or turning off or rebooting it.

Use of Programming Command

Besides the barcode programming method, the scanner can also be configured by serial commands (HEX) sent from the host device. **All commands must be entered in uppercase letters.**

Command Syntax

Prefix StorageType Tag SubTag {Data} [,SubTag {Data}] [;Tag SubTag {Data}] [...] Suffix

Prefix: "~<SOH>0000" (HEX: **7E 01 30 30 30 30**), 6 characters.

StorageType: "@" (HEX: **40**) or "#" (HEX: **23**), 1 character. "@" means permanent setting which will not be lost by removing power from the scanner or rebooting it; "#" means temporary setting which will be lost by removing power from the scanner or rebooting it.

Tag: A 3-character case-sensitive field that identifies the desired command group. For example, all USB HID-KBW configuration settings are identified with a Tag of KBW.

SubTag: A 3-character case-sensitive field that identifies the desired parameter within the tag group. For example, the SubTag for the keyboard layout is CTY.

Data: The value for a feature or parameter setting, identified by the Tag and SubTag.

Suffix: "<ETX>" (HEX: **3B 03**), 2 characters.

Multiple commands can be issued within one Prefix/Suffix sequence. For configuration commands, only the **Tag**, **SubTag**, and **Data** fields must be repeated for each command in sequence. If an additional command is to be applied to the same Tag, then the command is separated with a comma (,) and only the **SubTag** and **Data** fields of the additional commands are issued. If the additional command requires a different **Tag** field, the command is separated from previous command by a semicolon (;).

Query Commands

For query commands, the entry in the **Data** field in the syntax above is one of the following characters means:

* (HEX: **2A**) What is the scanner's current value for the setting(s).

& (HEX: **26**) What is the factory default value for the setting(s).

^ (HEX: **5E**) What is the range of possible values for the setting(s).

The value of the **StoreType** field in a query command can be either "@" (HEX: **40**) or "#" (HEX: **23**).

A query command with the **SubTag** field omitted means to query all the settings concerning a tag. For example, to query all the current settings about Code 11, you should enter **7E 01 30 30 30 30 40 43 31 31 2A 3B 03** (i.e. ~<SOH>0000@C11*; <ETX>).

Responses

Different from command sequence, the prefix of a response consists of the six characters of "<STX><SOH>0000" (HEX: **02 01 30 30 30 30**).

The scanner responds to serial commands with one of the following three responses:

<ACK> (HEX: **06**) Indicates a good command which has been processed.

<NAK> (HEX: **15**) Indicates a good configuration command with its **Data** field entry out of the allowable range for this Tag and SubTag combination (e.g. an entry for an inter-keystroke delay of 100 when the field will only allow 2 digits), or an invalid query command.

<ENQ> (HEX: **05**) Indicates an invalid Tag or SubTag command.

When responding, the scanner echoes back the command sequence with the status character above inserted directly before each of the punctuation marks (the comma or semicolon) in the command.

Examples

Example 1: Enable Code 11, set the minimum and maximum lengths to 12 and 22 respectively.

Enter: **7E 01 30 30 30 30 40 43 31 31 45 4E 41 31 2C 4D 49 4E 31 32 2C 4D 41 58 32 32 3B 03**
(~<SOH>0000@C11ENA1,MINI2,MAX22;<ETX>)

Response: **02 01 30 30 30 30 40 43 31 31 45 4E 41 31 06 2C 4D 49 4E 31 32 06 2C 4D 41 58 32 32 06 3B 03**
(<STX><SOH>0000@C11ENA1<ACK>,MINI2<ACK>,MAX22<ACK>;<ETX>)

Example 2: Query the current minimum and maximum lengths of Code 11.

Enter: **7E 01 30 30 30 30 40 43 31 31 4D 49 4E 2A 2C 4D 41 58 2A 3B 03**
(~<SOH>0000@C11MIN*,MAX*;<ETX>)

Response: **02 01 30 30 30 30 40 43 31 31 4D 49 4E 31 32 06 2C 4D 41 58 32 32 06 3B 03**

(<STX><SOH>0000@C11MIN12<ACK>,MAX22<ACK>;<ETX>)

Use of Programming Barcode

Programming barcode data (i.e. the characters under programming barcode) can be transmitted to the host device. Scan the appropriate barcode below to enable or disable the transmission of programming barcode data to the host device.



@SETUPT0

**** Do Not Transmit Programming Barcode Data**



@SETUPT1

Transmit Programming Barcode Data

Illumination



@ILLSCN1

**** On**



@ILLSCN0

Off

Illumination Color



@ILLCLR0

Red LED



@ILLCLR1

White LED



@ILLCLR4

Blue LED



@ILLCLR8

Intelligent Switch

Illumination Rotation Interval

This parameter sets the Illumination Rotation Interval. The default value is 2000ms.



@ILLSCT

Illumination Rotation Interval

Aiming

When scanning/capturing image, the scanner projects an aiming pattern which allows positioning the target barcode within its field of view and thus makes decoding easier.

Normal: The scanner projects an aiming pattern only during barcode scanning/capture.

Always On: Aiming pattern is constantly on after the scanner is powered on.

Off: Aiming pattern is off all the time.



@AMLENA1

** Normal



@AMLENA2

Always On



@AMLENA0

Off

Good Read LED

The green LED can be programmed to be On or Off to indicate good read.



@GRLENAI

**** On**



@GRLENAO

Off

Good Read LED Duration

This parameter sets the amount of time the Good Read LED remains on following a good read. It is programmable in 10ms increments from 20ms to 10,000ms.



@GRLDUR20

**** Short (20ms)**



@GRLDUR120

Medium (120ms)



@GRLDUR220

Long (220ms)



@GRLDUR320

Prolonged (320ms)



@GRLDUR

Custom (20 - 10,000ms)

E
xample

Set the Good Read LED duration to 800ms:

1. Scan the **Custom** barcode.
2. Scan the numeric barcodes "8", "0" and "0" from the "Digit Barcodes" section in Appendix.

-
3. Scan the **Save** barcode from the “Save/Cancel Barcodes” section in Appendix.

Power On Beep

The scanner can be programmed to beep when it is powered on. Scan the **Off** barcode if you do not want a power on beep.



@PWBENA1

**** On**



@PWBENA0

off

Good Read Beep

Scanning the **Off** barcode can turn off the beep that indicates successful decode; scanning the **On** barcode can turn it back on.



@GRBENA1

**** On**



@GRBENA0

off

Good Read Beep Volume



@GRBVLL20

Low Volume



@GRBVLL12

Medium Volume



@GRBVLL5

****High Volume**



@GRBVLL

Custom (1-10)

Scanning the below barcode can set the Good Read Beep Volume to low, medium and high.

Good Read Beep Duration

This parameter sets the length of the beep the scanner emits on a good read. It is programmable in 10ms increments from 20ms to 300ms.



@GRBDUR40

Short (40ms)



@GRBDUR80

**** Medium (80ms)**



@GRBDUR120

Long (120ms)



@GRBDUR

Custom (20 - 300ms)

E
xample

Set the Good Read Beep duration to 200ms:

1. Scan the **Custom** barcode.
2. Scan the numeric barcodes "2", "0" and "0" from the "Digit Barcodes" section in Appendix.
3. Scan the **Save** barcode from the "Save/Cancel Barcodes" section in Appendix.

Good Read Beep Frequency

This parameter is programmable in 1Hz increments from 20Hz to 20,000Hz.



@GRBFRQ800

Extra Low (800Hz)



@GRBFRQ1600

Low (1600Hz)



@GRBFRQ2730

**** Medium (2730Hz)**



@GRBFRQ4200

High (4200Hz)



@GRBFRQ

Custom (20 - 20,000Hz)

E
xample

Set the Good Read Beep frequency to 2,000Hz:

1. Scan the **Custom** barcode.
2. Scan the numeric barcodes "2", "0", "0" and "0" from the "Digit Barcodes" section in

Appendix.

3. Scan the **Save** barcode from the “Save/Cancel Barcodes” section in Appendix.

Number of Good Read Beeps

The number of beeps of a good read can be programmed from 1 to 9. To change the number of beeps, scan the barcode below and then scan a numeric barcode (1-9) and the **Save** barcode. The default value is 1.

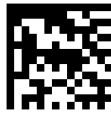

@GRBNUM

Number of Good Read Beeps

Good Read Beep Interval Time

Good Read Beep Interval Time modifies the interval time between beeps, and it becomes effective when the Number of Good Read Beeps is greater than one.



@GRBITV0

**** Short**



@GRBITV1

Medium

Good Read Vibration

You may choose whether or not to let the scanner vibrate when a barcode is successfully read by scanning the appropriate barcode below.



@GRVENA0

**** Off**



@GRVENA1

On

Good Read Vibration Duration

This parameter sets the length for the Good Read Vibration. It is programmable in 1ms increments from 100ms to 2,000ms. The default value is 300ms.

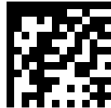

@GRVDUR

Set Good Read Vibration Duration

E
xample

Set the Good Read Vibration duration to 800ms:

1. Scan the Set Good Read Vibration Duration barcode.
2. Scan the numeric barcodes “8”, “0” and “0” from the “Digit Barcodes” section in Appendix.
3. Scan the Save barcode from the “Save/Cancel Barcodes” section in Appendix.

Scan Mode

Level Mode: A trigger pull activates a decode session. The decode session continues until a barcode is decoded or the trigger is released.

Trigger Mode: A trigger pull activates a decode session. The decode session continues until a barcode is decoded or reach the decode session timeout.

Sense Mode: The scanner activates a decode session every time when it detects a change in ambient illumination. The decode session continues until the barcode is decoded or the decode session timeout expires. Pressing the trigger can also activate a decode session.

Continuous Mode: The scanner automatically starts one decode session after another. To suspend/resume barcode reading, simply press the trigger. **Reread Timeout** can avoid undesired rereading of same barcode in a given period of time.

Pulse Mode: When the trigger is pulled and released, scanning is activated until a barcode is decoded or the decode session timeout expires (The decode session timeout begins when the trigger is released).

Batch Mode: A trigger pull activates a round of multiple decode sessions. This round of multiple scans continues until the trigger is released. Rereading the same barcode is not allowed in the same round.

Pre-Aiming Mode:When the user holds the scanner , the scanner lights up the aiming light to indicate the current position of the scanner before the user presses the button. After pressing the button, the scanner starts to read the bar code(the aimer is turned on or off according to the configuration of aimer mode. When the button is released or the barcode is decoded successfully, the code is stopped. When the user drops down the scanner for 3 seconds, the aiming lamp will turn off.



@SCNMOD0

Level Mode



@SCNMOD1

Trigger Mode



@SCNMOD2

Sense Mode



@SCNMOD3

Continuous Mode



@SCNMOD4

Pulse Mode



@SCNMOD13

**** Pre-Aiming Mode**



@SCNMOD7

Batch Mode

One Reading Timeout

This parameter sets the maximum time decode session continues during a scan attempt. It is programmable in 1ms increments from 1ms to 3,600,000ms. When it is set to 0, the timeout is infinite. The default setting is 3,000ms.



@ORTSET

One Reading Timeout

E
xample

Set the One Reading Timeout to 1,500ms:

1. Scan the **One Reading Timeout** barcode.
2. Scan the numeric barcodes "1", "5", "0" and "0" from the "Digit Barcodes" section in Appendix.
3. Scan the Save barcode from the "Save/Cancel Barcodes" section in Appendix.

Reading Interval

Reading Interval sets the time period between the end of one decode session and the start of next session. It is programmable in 1ms increments from 1ms to 10,000ms. The default timeout is 500ms. This feature is only applicable to the Continuous modes.



@SCNINV

Reading Interval

E
xample

Set the timeout between decodes to 800ms:

-
1. Scan the **Reading Interval** barcode.
 2. Scan the numeric barcodes “8”, “0” and “0” from the “Digit Barcodes” section in Appendix.
 3. Scan the **Save** barcode from the “Save/Cancel Barcodes” section in Appendix.

Image Stabilization Timeout (Sense Mode)

In the course of the sense mode, when the scanner stop reading, it will enter a new process of read-adaptation to the reading environment (image).After the Image Stabilization Timeout will the scanner enter the sense mode and wait for the barcode to present.Set the parameters of Image Stabilization Timeout could change the time to adapt the reading environment. It is programmable in 1ms increments from 1ms to 3,000ms. The default setting is 200ms.



@SENIST

Image Stabilization Timeout (Sense Mode)

Good Read Delay

Good Read Delay sets the minimum amount of time before the scanner can read another barcode. This parameter is programmable in 1ms increments from 1ms to 3,600,000ms. The default setting is 500ms. Scan the appropriate barcode below to enable or disable the delay.



@GRDENAI

Enable Good Read Delay



@GRDENA0

**** Disable Good Read Delay**

To set the good read delay, scan the barcode below, then set the delay (from 1 to 3,600,000ms) by scanning the digit barcode(s) then scanning the **Save** barcode from the Appendix.



@GRDDUR

Good Read Delay

E
sample

Set the good read delay to 1,000ms:

1. Scan the Good Read Delay barcode.
2. Scan the numeric barcodes "1", "0", "0" and "0" from the "Digit Barcodes" section in Appendix.
3. Scan the Save barcode from the "Save/Cancel Barcodes" section in Appendix.

Image Decoding Timeout

Image Decoding Timeout specifies the maximum time the scanner will spend decoding an image. This parameter is programmable in 1ms increments from 1ms to 3,000ms. The default timeout is 500ms.



@DETSSET

Image Decoding Timeout

E
xample

Set the image decoding timeout to 800ms:

1. Scan the **Image Decoding Timeout** barcode.
2. Scan the numeric barcodes "8", "0" and "0" from the "Digit Barcodes" section in Appendix.
3. Scan the **Save** barcode from the "Save/Cancel Barcodes" section in Appendix.

Scanning Preference

Normal Mode: Select this mode when reading barcodes on paper.

Screen Mode: Select this mode when reading barcodes on the screen.

High Motion Tolerance Mode: Select this mode when reading barcodes on moving objects.

Wide Adaptive Mode: Select this mode when application scenarios and code types are diversified.



@EXPLVL0

**** Normal Mode**



@EXPLVL4

High Motion Tolerance Mode



@EXPLVL5

Screen Mode



@EXPLVL6

Wide Adaptive Mode

Sensitivity

Sensitivity specifies the degree of acuteness of the scanner's response to changes in images captured. There are 20 levels to choose from. The smaller the value, the higher the sensitivity and the lower requirement in image change to trigger the scanner. You can select an appropriate degree of sensitivity that fits the application environment. The default setting is Level 1. This feature is only applicable to the Sense mode.



@SENLV14

Low Sensitivity



@SENLV11

Medium Sensitivity



@SENLV8

High Sensitivity



@SENLV5

Enhance Sensitivity



@SENLVL

****Custom Sensitivity**

E
example

Set the Sensitivity to 10:

1. Scan the **Custom Sensitivity** barcode.
2. Scan the numeric barcodes "1", "0" from the "Digit Barcodes" section in Appendix.
3. Scan the **Save** barcode from the "Save/Cancel Barcodes" section in Appendix.

Read Barcode On/Off

Sending the Read Barcode Off command **@NGRENA0** to the scanner can disable it from reading barcode, and the scanner is unable to scan barcode unless you send the Read Barcode On command **@NGRENA1** to it or power cycle it. By default, Read Barcode is On.

Decode Area

Whole Area Decoding: The scanner attempts to decode barcode(s) within its field of view, from the center to the periphery, and transmits the barcode that has been first decoded.

Specific Area Decoding: The scanner attempts to read barcode(s) within a specified decoding area and transmits the barcode that has been first decoded. This option allows the scanner to narrow its field of view to make sure it reads only those barcodes intended by the user. For instance, if multiple barcodes are placed closely together, specific area decoding in conjunction with appropriate pre-defined decoding area will insure that only the desired barcode is read.

Acuscan: The scanner only decodes the barcode aimed squarely by the aiming pattern. For those using a crosshair aiming pattern, only the barcode aimed by the center of crosshair will be decoded.

Priori On Aimed Barcode: The scanner attempts to decode priority the aimed barcode(s). If there is no barcode in the aimed area, the scanner would decode the barcode which is close to the aiming area first.

Acuread Decoding

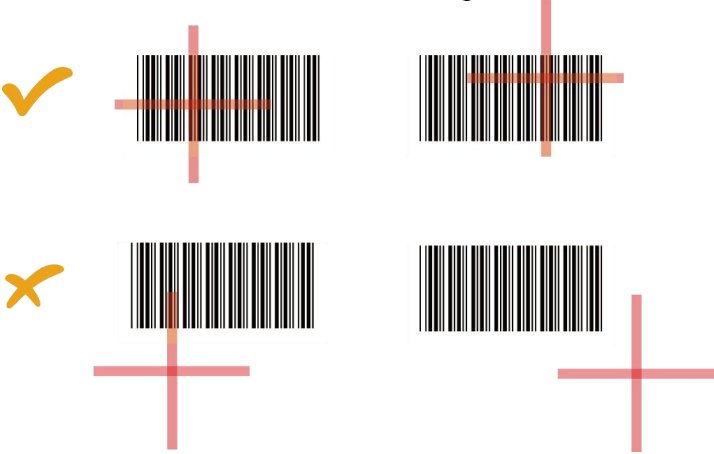



@CADENA0

Whole Area Decoding



@CADENA1

Specific Area Decoding



@CADENA2

Acuscan



@CADENA4;

****Priori On Aimed Barcode**

If **Specific Area Decoding** is enabled, the scanner only reads barcodes that intersect the predefined decoding area.

The default decoding area is an area of 40% top, 60% bottom, 40% left and 60% right of the scanner's field of view

You can define the decoding area using the **Top of Decoding Area**, **Bottom of Decoding Area**, **Left of Decoding Area** and **Right of Decoding Area** barcodes as well as numeric barcode(s) that represent(s) a desired percentage (0-100). The value of Bottom must be greater than that of Top; the value of Right must be greater than that of Left.



@CADTOP

Top of Decoding Area



@CADBOT

Bottom of Decoding Area



@CADLEF

Left of Decoding Area



@CADRIG

Right of Decoding Area



E *example*

Program the scanner to only read Barcode 1 in the figure above by setting the decoding area to 10% top, 45% bottom, 15% left and 30% right:

1. Scan the **Top of Decoding Area** barcode.
2. Scan the numeric barcode "0" from the "Digit Barcodes" section in Appendix.
3. Scan the **Save** barcode from the "Save/Cancel Barcodes" section in Appendix.
4. Scan the **Bottom of Decoding Area** barcode.
5. Scan the numeric barcodes "4" and "5" from the "Digit Barcodes" section in Appendix.
6. Scan the **Save** barcode from the "Save/Cancel Barcodes" section in Appendix.
7. Scan the **Top of Decoding Area** barcode.
8. Scan the numeric barcodes "1" and "0" from the "Digit Barcodes" section in Appendix.
9. Scan the **Save** barcode from the "Save/Cancel Barcodes" section in Appendix.
10. Scan the **Left of Decoding Area** barcode.
11. Scan the numeric barcode "0" from the "Digit Barcodes" section in Appendix.
12. Scan the **Save** barcode from the "Save/Cancel Barcodes" section in Appendix.
13. Scan the **Right of Decoding Area** barcode.
14. Scan the numeric barcodes "3" and "0" from the "Digit Barcodes" section in Appendix.
15. Scan the **Save** barcode from the "Save/Cancel Barcodes" section in Appendix.
16. Scan the **Left of Decoding Area** barcode.
17. Scan the numeric barcodes "1" and "5" from the "Digit Barcodes" section in Appendix.
18. Scan the **Save** barcode from the "Save/Cancel Barcodes" section in Appendix.

Image Flipping



@MIRRORO

**** Do Not Flip**



@MIRROR1

Flip Horizontally

Example of image not flipped



Example of image flipped horizontally



Image Resize

This option alters image resolution before compression. Multiple pixels are combined to one pixel, resulting in a smaller image containing the original content with reduced resolution. You can set to original image or resize by 50% on both horizontal and vertical.



@IMGRSE0

**** Original Image**



@IMGRSE1

**Resize By 50% On Both Horizontal And
Vertical**

Transmit Not Good Read Message

- ✧ Enable: When the code failed to decoded, and you release the trigger or Decode Session Timeout , Not Good Read Message will be sent to the host.
- ✧ Disable: When the code failed to decoded, Not Good Read Message will not be sent to the host.



@NGRENA0

** Disable



@NGRENA1

Enable

Edit NGR Message

Not Good Read Message supports up to 7 characters, from 0 to oxff. (Default: NG)



@NGRSET

Edit NGR Message

Image Filter

Sets the filter to be applied to the image before being processed. This parameter can be used to successfully decode particular ink-spread printed codes (ex. direct part mark codes). Different filters can be applied to a single code. See the NSet User's Manual for examples of Image Filter application.

Default Settings

Factory Defaults

Scanning the following barcode can restore the scanner to the factory defaults.

You may need to reset all parameters to the factory defaults when:

- ✧ scanner is not properly configured so that it fails to decode barcodes.
- ✧ you forget previous configuration and want to avoid its impact.



@FACDEF

Restore All Factory Defaults

Custom Defaults

Scanning the **Restore All Custom Defaults** barcode can reset all parameters on the scanner to the custom defaults. Scanning the **Save as Custom Defaults** barcode can set the current settings as custom defaults.

Custom defaults are stored in the non-volatile memory.



@CUSSAV

Save as Custom Defaults



@CUSDEF

Restore All Custom Defaults



Restoring the scanner to the factory defaults will not remove the custom defaults from the scanner.

Query Scanner Information

After scanning the barcode below, the scanner information (including product name, firmware version, decoder version, hardware version, product serial number, OEM serial number and manufacturing date) will be sent to the host device.



@QRYSYS

Query Scanner Information

Query Product Name



@QRYPDN

Query Product Name

Query Firmware Version



@QRYFWV

Query Firmware Version

Query Decoder Version



@QRYDCV

Query Decoder Version

Query Hardware Version



@QRYHWV

Query Hardware Version

Query Serial Number



@QRYPSN

Query Serial Number

Query Manufacturing Date



@QRYDAT

Query Manufacturing Date

Chapter 4 RS-232 Interface

Introduction

When the cradle is connected to the RS-232 port of a host device, you need to set communication parameters (including baud rate, parity check, data bit and stop bit) on the cradle to match the host device so that two devices can communicate with each other.



@INTERFO

RS-232

Baud Rate

Baud rate is the number of bits of data transmitted per second. Set the baud rate to match the host requirements.



@232BAD8

115200



@232BAD7

57600



@232BAD6

38400



@232BAD5

19200



@232BAD4

14400



@232BAD2

4800



@232BAD0

1200



@232BAD3

****9600**



@232BAD1

2400

Parity Check

Set the parity type to match the host requirements.

Odd Parity: If the data contains an odd number of 1 bits, the parity bit value is set to 0.

Even Parity: If the data contains an even number of 1 bits, the parity bit value is set to 0.

None: Select this option when no parity bit is required.



@232PAR0

**** None**



@232PAR2

Odd Parity



@232PAR1

Even Parity

Data Bit

Set the number of data bits to match the host requirements.



@232DAT1

7 Data Bits



@232DAT0

**** 8 Data Bits**

Stop Bit

The stop bit(s) at the end of each transmitted character marks the end of transmission of one character and prepares the receiving device for the next character in the serial data stream. Set the number of stop bits to match the host requirements.



@232STP0

**** 1 Stop Bit**



@232STP1

2 Stop Bits

Hardware Auto Flow Control

If this feature is enabled, the cradle determines whether to transmit data based on CTS signal level. When CTS signal is at a low level which means the serial port's cache memory of receiving device (such as PC) is full, the cradle sends data through RS-232 port until CTS signal is set to high level by receiving device. When the cradle is not ready for receiving, it will set RTS signal to low level. When sending device (such as PC) detects it, it will not send data to the cradle any more to prevent data loss.

If this feature is disabled, reception/transmission of serial data will not be influenced by RTS/CTS signal.



@232AFLO

**** Disable Hardware Auto Flow Control**



@232AFLI

Enable Hardware Auto Flow Control



Before enabling this feature, make sure that RTS/CTS signal lines are contained in RS-232 cable. Without the signal lines, RS-232 communication errors will occur.

Chapter 5 USB Interface

Introduction

There are two options for USB connection between the cradle and host device:

- ✧ USB HID Keyboard: The cradle's transmission is simulated as USB keyboard input with no need for command configuration or a driver. Barcode data could be entered by the virtual keyboard directly and it is also convenient for the host device to receive data.
- ✧ USB CDC: It is compliant with the standard USB CDC class specifications defined by the USB-IF and allows the host device to receive data in the way as a serial port does. A driver is needed when using this feature.

When the scanner is connected to both USB and RS-232 ports on a host device, it will select the USB connection by default.

USB HID Keyboard

When the cradle is connected to the USB port on a host device, you can enable the USB HID Keyboard feature by scanning the barcode below. The cradle's transmission will be simulated as USB keyboard input. The Host receives keystrokes on the virtual keyboard. It works on a Plug and Play basis and no driver is required.



@INTERF3

**** USB HID Keyboard**



If the host device allows keyboard input, then no extra software is needed for HID Keyboard input.

USB Country Keyboard Types

Keyboard layouts vary from country to country. The default setting is U.S. keyboard.



@KBWCTY0

**** U.S. (English)**



@KBWCTY1

Belgium



@KBWCTY2

Brazil



@KBWCTY3

Canada (French)



@KBWCTY4

Czechoslovakia



@KBWCTY5

Denmark



@KBWCTY6

Finland (Swedish)



@KBWCTY7

France



@KBWCTY8

Germany/ Austria



@KBWCTY9

Greece



@KBWCTY10

Hungary



@KBWCTY11

Israel (Hebrew)



@KBWCTY12

Italy



@KBWCTY13

Latin America/ South America



@KBWCTY14

Netherlands (Dutch)



@KBWCTY15

Norway



@KBWCTY16

Poland



@KBWCTY17

Portugal



@KBWCTY18

Romania



@KBWCTY21

Slovakia



@KBWCTY23

Sweden



@KBWCTY25

Turkey_F



@KBWCTY19

Russia



@KBWCTY22

Spain



@KBWCTY24

Switzerland (German)



@KBWCTY26

Turkey_Q



@KBWCTY27

UK



@KBWCTY28

Japan

Beep on Unknown Character

Due to the differences in keyboard layouts, some characters contained in barcode data may be unavailable on the selected keyboard. As a result, the scanner fails to transmit the unknown characters.

Scan the appropriate barcode below to enable or disable the emission of beep when an unknown character is detected.



@KBWBUC0

**** Do Not Beep on Unknown Character**



@KBWBUC1

Beep on Unknown Character

Emulate ALT+Keypad

When **Emulate ALT+Keypad** is turned on, any ASCII character (0x00 - 0xFF) is sent over the numeric keypad no matter which keyboard type is selected.

1. ALT Make
2. Enter the number corresponding to a desired character on the keypad.
3. ALT Break

After **Emulate ALT+Keypad ON** is selected, you need to choose the code page with which the barcodes were created and to turn **Unicode Encoding** On or Off depending on the encoding used by the application software.



@KBWALTO

**** Emulate ALT+Keypad OFF**



@KBWALTI

Emulate ALT+Keypad ON



Since sending a character involves multiple keystroke emulations, this method appears less efficient.

E *sample*

Supposing **Emulate ALT+Keypad** is ON, **Unicode Encoding** is Off, and **Code Page 1252 (West European Latin)** is selected, barcode data "ADF" (65/208/70) is sent as below:

"A" -- "ALT Make" + "065" + "ALT Break"

"D" -- "ALT Make" + "208" + "ALT Break"

"F" -- "ALT Make" + "070" + "ALT Break"

Code Page

Code pages define the mapping of character codes to characters. If the data received does not display with the proper characters, it may be because the barcode being scanned was created using a code page that is different from the one the host program is expecting. If this is the case, select the code page with which the barcodes were created by scanning the appropriate barcode below. For PDF417, QR Code, Aztec and Data Matrix, besides setting the code page, you also need to set the character encoding in the “Character Encoding” section in Chapter 7. This feature is only effective when **Emulate ALT+Keypad** is turned on.



@KBWC PG0

**** Code Page 1252 (West European Latin)**



@KBWC PG1

Code Page 1251 (Cyrillic)



@KBWC PG2

Code Page 1250 (Central and East European Latin)



@KBWC PG3

Code Page 1253 (Greek)



@KBWC PG4

Code Page 1254 (Turkish)



@KBWCPG5

Code Page 1255 (Hebrew)



@KBWCPG6

Code Page 1256 (Arabic)



@KBWCPG7

Code Page 1257 (Baltic)



@KBWCPG8

Code Page 1258 (Vietnamese)



@KBWCPG9

**Code Page 936 (Simplified Chinese,
GB2312,GBK)**



@KBWCPG10

Code Page 950 (Traditional Chinese, Big5)



@KBWCPG11

Code Page 874(Thai)



@KBWCPG12

Code Page 932 (Japanese, Shift-JIS)

Unicode Encoding

Different host program may use different character encodings for handling incoming barcode data. For instance, Microsoft Office Word uses Unicode encoding and therefore you should turn **Unicode Encoding** on, whereas Microsoft Office Excel or Notepad uses Code Page encoding and therefore you should turn **Unicode Encoding** off. This feature is only effective when **Emulate ALT+Keypad** is turned on.



@KBWCPU0

**** Off**



@KBWCPU1

On

Function Key Mapping

When **Ctrl+ASCII Mode** is selected, function characters (0x00 - 0x1F) are sent as ASCII sequences.

1. CTRL Make
2. Press function key
3. CTRL Break



@KBWFKM0

**** Disable**



@KBWFKM1

Ctrl+ASCII Mode

E *example*

If **Ctrl+ASCII Mode** is selected and other parameters of USB HID Keyboard adopt factory defaults, barcode data "A<HT>(i.e. Horizontal Tab)F" (0x41/0x09/0x46) is sent as below:

"A" - Keystroke "A".

<HT> - "Ctrl Make" + Keystroke "I" + "Ctrl Break"

"F" - Keystroke "F"

For some text editors, "Ctrl I" means italic convert. So the output may be "AF".



Emulate ALT+Keypad ON prevails over **Ctrl+ASCII Mode**.

ASCII Function Key Mapping Table

ASCII Function	ASCII Value (HEX)	Function Key Mapping Disabled	Ctrl+ASCII
NUL	00	Null	Ctrl+@
SOH	01	Keypad Enter	Ctrl+A
STX	02	Caps Lock	Ctrl+B
ETX	03	ALT	Ctrl+C
EOT	04	Null	Ctrl+D
ENQ	05	CTRL	Ctrl+E
ACK	06	Null	Ctrl+F
BEL	07	Enter	Ctrl+G
BS	08	Left Arrow	Ctrl+H
HT	09	Horizontal Tab	Ctrl+I
LF	0A	Down Arrow	Ctrl+J
VT	0B	Vertical Tab	Ctrl+K
FF	0C	Delete	Ctrl+L
CR	0D	Enter	Ctrl+M
SO	0E	Insert	Ctrl+N
SI	0F	Esc	Ctrl+O
DLE	10	F11	Ctrl+P
DC1	11	Home	Ctrl+Q
DC2	12	PrintScreen	Ctrl+R
DC3	13	Backspace	Ctrl+S
DC4	14	tab+shift	Ctrl+T
NAK	15	F12	Ctrl+U
SYN	16	F1	Ctrl+V
ETB	17	F2	Ctrl+W
CAN	18	F3	Ctrl+X
EM	19	F4	Ctrl+Y
SUB	1A	F5	Ctrl+Z
ESC	1B	F6	Ctrl+[
FS	1C	F7	Ctrl+\
GS	1D	F8	Ctrl+]
RS	1E	F9	Ctrl+6
US	1F	F10	Ctrl+-

ASCII Function Key Mapping Table (Continued)

The last five characters (0x1B~0x1F) in the table above apply to US keyboard layout only. The following chart provides the equivalents of these five characters for other countries.

Country	Ctrl+ASCII					
United States	Ctrl+[Ctrl+\	Ctrl+]	Ctrl+6	Ctrl+-	
Belgium	Ctrl+[Ctrl+<	Ctrl+]	Ctrl+6	Ctrl+-	
Scandinavia	Ctrl+8	Ctrl+<	Ctrl+9	Ctrl+6	Ctrl+-	
France	Ctrl+^	Ctrl+8	Ctrl+\$	Ctrl+6	Ctrl+=	
Germany		Ctrl+Ã	Ctrl++	Ctrl+6	Ctrl+-	
Italy		Ctrl+\	Ctrl++	Ctrl+6	Ctrl+-	
Switzerland		Ctrl+<	Ctrl+..	Ctrl+6	Ctrl+-	
United Kingdom	Ctrl+[Ctrl+ç	Ctrl+]	Ctrl+6	Ctrl+-	
Denmark	Ctrl+8	Ctrl+\	Ctrl+9	Ctrl+6	Ctrl+-	
Norway	Ctrl+8	Ctrl+\	Ctrl+9	Ctrl+6	Ctrl+-	
Spain	Ctrl+[Ctrl+\	Ctrl+]	Ctrl+6	Ctrl+-	

Inter-Keystroke Delay

This parameter specifies the delay between emulated keystrokes.



@KBWDLY0

**** No Delay**



@KBWDLY40

Long Delay (40ms)



@KBWDLY20

Short Delay (20ms)

Caps Lock

The **Caps Lock ON** option can invert upper and lower case characters contained in barcode data. This inversion occurs regardless of the state of Caps Lock key on the host device's keyboard.



@KBWCAPO

**** Caps Lock OFF**



@KBWCAP1

Caps Lock ON



Emulate ALT+Keypad ON/ Convert All to Upper Case/ Convert All to Lower Case prevails over **Caps Lock ON**.

E
xample

When the **Caps Lock ON** feature is selected, barcode data "AbC" is transmitted as "aBc".

Convert Case

You may scan the appropriate barcode below to convert all barcode data to your desired case.



@KBWCAS0

**** No Case Conversion**



@KBWCAS1

Convert All to Upper Case



@KBWCAS2

Convert All to Lower Case

E
xample

When the **Convert All to Lower Case** feature is enabled, barcode data "AbC" is transmitted as "abc".



If **Emulate ALT+Keypad ON** is selected, **Convert All to Lower Case** and **Convert All to Upper Case** do not function.

Emulate Numeric Keypad



Do Not Emulate Numeric Keypad 1: Sending a number (0-9) is emulated as keystroke(s) on main keyboard.

Emulate Numeric Keypad 1: Sending a number (0-9) is emulated as keystroke(s) on numeric keypad. The state of Num Lock on the simulated numeric keypad is determined by its equivalent on the host device. If Num Lock on the host device is turned off, the output of simulated numeric keypad is function key instead of number.

Do Not Emulate Numeric Keypad 2: Sending "+", "-", "*", and "/" is emulated as keystroke(s) on main keyboard.

Emulate Numeric Keypad 2: Sending "+", "-", "*", and "/" is emulated as keystroke(s) on numeric keypad.



@KBWNUM0

**** Do Not Emulate Numeric Keypad 1**



@KBWNUM1

Emulate Numeric Keypad 1



@KBWNCH0

**** Do Not Emulate Numeric Keypad 2**



@KBWNCHI

Emulate Numeric Keypad 2



Emulate ALT+Keypad ON prevails over **Emulate Numeric Keypad**.

E *example*

Supposing the **Emulate Numeric Keypad 1** feature is enabled:

if Num Lock on the host device is ON, "A4.5" is transmitted as "A4.5";

if Num Lock on the host device is OFF, "A4.5" is transmitted as ".A":

1. "A" is sent on main keyboard;
2. "4" is sent as the function key "Cursor Move to Left";
3. "." is sent on main keyboard;
4. "5" is not sent as it does not correspond to any function key.

Polling Rate

This parameter specifies the polling rate for a USB keyboard. If the Host drops characters, change the polling rate to a bigger value.



@KBWPOR0

1ms



@KBWPOR1

2ms



@KBWPOR2

3ms



@KBWPOR3

**** 4ms**



@KBWPOR4

5ms



@KBWPOR5

6ms



@KBWPOR6

7ms



@KBWPOR7

8ms



@KBWPOR8

9ms



@KBWPOR9

10ms

USB CDC

If your cradle is connected to the USB port on a host device, the USB CDC feature allows the host device to receive data in the way as a serial port does. A driver is needed when using this feature. You may download it from our website at www.newlandaidc.com.



@INTERF8

USB CDC

USB HID-POS

Introduction

The HID-POS interface is recommended for new application programs. It can send up to 56 characters in a single USB report and appears more efficient than keyboard emulation.

Features:

- ✧ HID based, no custom driver required.
- ✧ Way more efficient in communication than keyboard emulation and traditional RS-232 interface.

Note: HID-POS does not require a custom driver. However, a HID interface on Windows 98 does. All HID interfaces employ standard driver provided by the operating system. Use defaults when installing the driver.



@INTERF8

USB HID-POS

Access the Scanner with Your Program

Use CreateFile to access the scanner as a HID device and then use ReadFile to deliver the scanned data to the application program. Use WriteFile to send data to the scanner.

For detailed information about USB and HID interfaces, go to www.USB.org.

Acquire Scanned Data

After a barcode is decoded, the scanner sends an input report as below:

	Bit							
Byte	7	6	5	4	3	2	1	0
0	Report ID = 0x02							
1	Barcode Length							
2-57	Decoded Data (1-56)							
58-61	Reserved (1-4)							
62	Newland Symbology Identifier or N/C: 0x00							
63	-	-	-	-	-	-	-	Decoded data continued

Send Command to the Scanner

This output report is used to send commands to the scanner. All programming commands can be used.

	Bit							
Byte	7	6	5	4	3	2	1	0
0	Report ID = 0x04							
1	Length of command							
2-62	Command							
63	-	-	-	-	-	-	-	Command continued

VID/PID

USB uses VID (Vendor ID) and PID (Product ID) to identify and locate a device. The VID is assigned by USB Implementers Forum. Newland's vendor ID is 1EAB (Hex). A range of PIDs are used for each Newland product family. Every PID contains a base number and interface type (keyboard, COM port, etc.).

Product	Interface	PID (Hex)	PID (Dec)
NVH220	USB HID Keyboard	2E22	11810
	USB CDC	2E06	11782
	USB HID-POS	2E10	11792

Chapter 6 Symbologies

Introduction

Every symbology (barcode type) has its own unique attributes. This chapter provides programming barcodes for configuring the scanner so that it can identify various symbologies. It is recommended to disable those that are rarely used to increase the efficiency of the scanner.

Global Settings

Enable/Disable All Symbologies

If the **Disable All Symbologies** feature is enabled, the scanner will not be able to read any non-programming barcodes except the programming barcodes.



@ALLEN A1

Enable All Symbologies



@ALLEN A0

Disable All Symbologies

Enable/Disable 1D Symbologies



@ALL1DC1

Enable 1D Symbologies



@ALL1DC0

Disable 1D Symbologies

Enable/Disable 2D Symbologies



@ALL2DC1

Enable 2D Symbologies



@ALL2DC0

Disable 2D Symbologies



Enable Disable 2D Symbologies, the Programming Barcode of 2D Data Matrix in this User Guide will be invalid. It is recommended to use NSet to reactive Data Matrix or scan these barcodes below.



#SETUPE1

Enter Setup



@DMCENA1

Enable Data Matrix



#SETUPE0

Exit Setup

Image Brightness Adaptation

The two parameters of image brightness adaptation 1 and 2, which are linkage relations, are set to adapt to the brightness of the image. When the image is too dark, two parameters can be adjusted down at the same time; When the image is too bright, you can try to raise both parameters at the same time.



@CCFCTV

Image Brightness Adaptation 1



@CCFMTV

Image Brightness Adaptation 2

ID Decoding Complexity

The Decoding Complexity parameter selects the decoding algorithm according to the printing/marking technique used to create the symbol and on the overall printing/marking quality.

- ✧ Low: For no stain, wrinkle and other high-quality barcodes;
- ✧ Medium: Bar code with general quality such as certain dirt, fold, etc;
- ✧ High: For Bar code with poor printing quality.



@CCFIDC0

Low



@CCFIDC2

High



@CCFIDC1

****Medium**

1D Inverse



@CCFIV0

Regular



@CCFIV2

****Regular and Inverse**

Code 128

Restore Factory Defaults



@128DEF

Restore the Factory Defaults of Code 128

Enable/Disable Code 128



@128ENA1

**** Enable Code 128**



@128ENA0

Disable Code 128



If the scanner fails to identify Code 128 barcodes, you may first try this solution by scanning the **Enable Code 128** barcode.

Set Length Range for Code 128

The scanner can be configured to only decode Code 128 barcodes with lengths that fall between (inclusive) the minimum and maximum lengths. To accomplish it, you need to set the minimum and maximum lengths.



@128MIN

Set the Minimum Length (Default: 1)



@128MAX

Set the Maximum Length (Default: 48)



If minimum length is set to be greater than maximum length, the scanner only decodes Code 128 barcodes with either the minimum or maximum length. If minimum length is same as maximum length, only Code 128 barcodes with that length are to be decoded.



Set the scanner to decode Code 128 barcodes containing between 8 and 12 characters:

1. Scan the **Set the Minimum Length** barcode.
2. Scan the numeric barcode "8" from the "Digit Barcodes" section in Appendix.
3. Scan the **Save** barcode from the "Save/Cancel Barcodes" section in Appendix.
4. Scan the **Set the Maximum Length** barcode.
5. Scan the numeric barcodes "1" and "2" from the "Digit Barcodes" section in Appendix.
6. Scan the **Save** barcode from the "Save/Cancel Barcodes" section in Appendix.

EAN-8

Restore Factory Defaults



@EA8DEF

Restore the Factory Defaults of EAN-8

Enable/Disable EAN-8



@EA8ENA1

**** Enable EAN-8**



@EA8ENA0

Disable EAN-8



If the scanner fails to identify EAN-8 barcodes, you may first try this solution by scanning the **Enable EAN-8** barcode.

Transmit Check Character

EAN-8 is 8 digits in length with the last one as its check character used to verify the integrity of the data.



@EA8CHK2

**** Transmit EAN-8 Check Character**



@EA8CHK1

Do Not Transmit EAN-8 Check Character

2-Digit Add-On Code

An EAN-8 barcode can be augmented with a two-digit add-on code to form a new one. In the example below, the part surrounded by blue dotted line is an EAN-8 barcode while the part circled by red dotted line is a two-digit add-on code.



@EA8AD20

**** Disable 2-Digit Add-On Code**



@EABAD21

Enable 2-Digit Add-On Code



Disable 2-Digit Add-On Code: The scanner decodes EAN-8 and ignores the add-on code when presented with an EAN-8 plus 2-digit add-on barcode. It can also decode EAN-8 barcodes without 2-digit add-on codes.

Enable 2-Digit Add-On Code: The scanner decodes a mix of EAN-8 barcodes with and without 2-digit add-on codes.

5-Digit Add-On Code

An EAN-8 barcode can be augmented with a five-digit add-on code to form a new one. In the example below, the part surrounded by blue dotted line is an EAN-8 barcode while the part circled by red dotted line is a five-digit add-on code.



@EA8AD50

**** Disable 5-Digit Add-On Code**



@EA8AD51

Enable 5-Digit Add-On Code



Disable 5-Digit Add-On Code: The scanner decodes EAN-8 and ignores the add-on code when presented with an EAN-8 plus 5-digit add-on barcode. It can also decode EAN-8 barcodes without 5-digit add-on codes.

Enable 5-Digit Add-On Code: The scanner decodes a mix of EAN-8 barcodes with and without 5-digit add-on codes.

Add-On Code Required

When **EAN-8 Add-On Code Required** is selected, the scanner will only read EAN-8 barcodes that contain add-on codes.



@EA8REQ1

EAN-8 Add-On Code Required



@EA8REQ0

**** EAN-8 Add-On Code Not Required**

Add-On Code Separator

When this feature is on, there is a space between the data from the barcode and the data from the add-on code. When turned off, there is no space.



@EA8SEPO

**** Off**



@EA8SEPI

On

Convert EAN-8 to EAN-13

Convert EAN-8 to EAN-13: Convert EAN-8 decoded data to EAN-13 format before transmission. After conversion, the data follows EAN-13 format and is affected by EAN-13 programming selections (e.g., Check Character).

Do Not Convert EAN-8 to EAN-13: EAN-8 decoded data is transmitted as EAN-8 data, without conversion.



@EA8EXPO

**** Do Not Convert EAN-8 to EAN-13**



@EA8EXPI

Convert EAN-8 to EAN-13

EAN-13

Restore Factory Defaults



@E13DEF

Restore the Factory Defaults of EAN-13

Enable/Disable EAN-13



@E13ENA1

**** Enable EAN-13**



@E13ENA0

Disable EAN-13



If the scanner fails to identify EAN-13 barcodes, you may first try this solution by scanning the **Enable EAN-13** barcode.

Transmit Check Character



@E13CHK2

**** Transmit EAN-13 Check Character**



@E13CHK1

**Do Not Transmit EAN-13 Check
Character**

2-Digit Add-On Code

An EAN-13 barcode can be augmented with a two-digit add-on code to form a new one. In the example below, the part surrounded by blue dotted line is an EAN-13 barcode while the part circled by red dotted line is a two-digit add-on code.



@E13AD20

**** Disable 2-Digit Add-On Code**



@E13AD21

Enable 2-Digit Add-On Code



Disable 2-Digit Add-On Code: The scanner decodes EAN-13 and ignores the add-on code when presented with an EAN-13 plus 2-digit add-on barcode. It can also decode EAN-13 barcodes without 2-digit add-on codes.

Enable 2-Digit Add-On Code: The scanner decodes a mix of EAN-13 barcodes with and without 2-digit add-on codes.

5-Digit Add-On Code

An EAN-13 barcode can be augmented with a five-digit add-on code to form a new one. In the example below, the part surrounded by blue dotted line is an EAN-13 barcode while the part circled by red dotted line is a five-digit add-on code.



@E13AD50

**** Disable 5-Digit Add-On Code**



@E13AD51

Enable 5-Digit Add-On Code



Disable 5-Digit Add-On Code: The scanner decodes EAN-13 and ignores the add-on code when presented with an EAN-13 plus 5-digit add-on barcode. It can also decode EAN-13 barcodes without 5-digit add-on codes.

Enable 5-Digit Add-On Code: The scanner decodes a mix of EAN-13 barcodes with and without 5-digit add-on codes.

Add-On Code Required

When **EAN-13 Add-On Code Required** is selected, the scanner will only read EAN-13 barcodes that contain add-on codes.



@E13REQ0

**** EAN-13 Add-On Code Not Required**



@E13REQ1

EAN-13 Add-On Code Required

Add-On Code Separator

When this feature is on, there is a space between the data from the barcode and the data from the add-on code. When turned off, there is no space.



@E13SEP0

**** Off**



@E13SEP1

On

EAN-13 Beginning with 290 Add-On Code Required

This setting programs the scanner to require an add-on code (2-digit or 5-digit) on EAN-13 barcodes that begin with "290". The following settings can be programmed:

Require Add-On Code: All EAN-13 barcodes that begin with "290" must have a 2-digit or 5-digit add-on code. The EAN-13 barcode with the add-on code is then transmitted. If the required add-on code is not found, the

EAN-13 barcode is discarded.

Do Not Require Add-On Code: If you have selected **Require Add-On Code**, and you want to disable this feature, scan **Do Not Require Add-On Code**. EAN-13 barcodes are handled, depending on your selection for the “Add-On Code Required” feature.



@E132900

**** Do Not Require Add-On Code**



@E132901

Require Add-On Code

EAN-13 Beginning with 378/379 Add-On Code Required

This setting programs the scanner to require an add-on code (2-digit or 5-digit) on EAN-13 barcodes that begin with a “378” or “379”. The following settings can be programmed:

Require Add-On Code: All EAN-13 barcodes that begin with a “378” or “379” must have a 2-digit or 5-digit add-on code. The EAN-13 barcode with the add-on code is then transmitted. If the required add-on code is not found, the EAN-13 barcode is discarded.

Do Not Require Add-On Code: If you have selected **Require Add-On Code**, and you want to disable this feature, scan **Do Not Require Add-On Code**. EAN-13 barcodes are handled, depending on your selection for the “Add-On Code Required” feature.



@E133780

**** Do Not Require Add-On Code**



@E133781

Require Add-On Code

EAN-13 Beginning with 414/419 Add-On Code Required

This setting programs the scanner to require an add-on code (2-digit or 5-digit) on EAN-13 barcodes that begin with a “414” or “419”. The following settings can be programmed:

Require Add-On Code: All EAN-13 barcodes that begin with a “414” or “419” must have a 2-digit or 5-digit add-on code. The EAN-13 barcode with the add-on code is then transmitted. If the required add-on code is not found, the EAN-13 barcode is discarded.

Do Not Require Add-On Code: If you have selected **Require Add-On Code**, and you want to disable this feature, scan **Do Not Require Add-On Code**. EAN-13 barcodes are handled, depending on your selection for the “Add-On Code Required” feature.



@E134140

**** Do Not Require Add-On Code**



@E134141

Require Add-On Code

EAN-13 Beginning with 434/439 Add-On Code Required

This setting programs the scanner to require an add-on code (2-digit or 5-digit) on EAN-13 barcodes that begin with a “434” or “439”. The following settings can be programmed:

Require Add-On Code: All EAN-13 barcodes that begin with a “434” or “439” must have a 2-digit or 5-digit add-on code. The EAN-13 barcode with the add-on code is then transmitted. If the required add-on code is

not found, the EAN-13 barcode is discarded.

Do Not Require Add-On Code: If you have selected **Require Add-On Code**, and you want to disable this feature, scan **Do Not Require Add-On Code**. EAN-13 barcodes are handled, depending on your selection for the “Add-On Code Required” feature.



@E134340

**** Do Not Require Add-On Code**



@E134341

Require Add-On Code

EAN-13 Beginning with 977 Add-On Code Required

This setting programs the scanner to require an add-on code (2-digit or 5-digit) on EAN-13 barcodes that begin with “977”. The following settings can be programmed:

Require Add-On Code: All EAN-13 barcodes that begin with “977” must have a 2-digit or 5-digit add-on code. The EAN-13 barcode with the add-on code is then transmitted. If the required add-on code is not found, the EAN-13 barcode is discarded.

Do Not Require Add-On Code: If you have selected **Require Add-On Code**, and you want to disable this feature, scan **Do Not Require Add-On Code**. EAN-13 barcodes are handled, depending on your selection for the “Add-On Code Required” feature.



@E139770

**** Do Not Require Add-On Code**



@E139771

Require Add-On Code

EAN-13 Beginning with 978 Add-On Code Required

This setting programs the scanner to require an add-on code (2-digit or 5-digit) on EAN-13 barcodes that begin with “978”. The following settings can be programmed:

Require Add-On Code: All EAN-13 barcodes that begin with “978” must have a 2-digit or 5-digit add-on code. The EAN-13 barcode with the add-on code is then transmitted. If the required add-on code is not found, the EAN-13 barcode is discarded.

Do Not Require Add-On Code: If you have selected **Require Add-On Code**, and you want to disable this feature, scan **Do Not Require Add-On Code**. EAN-13 barcodes are handled, depending on your selection for the “Add-On Code Required” feature.



@E139780

**** Do Not Require Add-On Code**



@E139781

Require Add-On Code

EAN-13 Beginning with 979 Add-On Code Required

This setting programs the scanner to require an add-on code (2-digit or 5-digit) on EAN-13 barcodes that begin with “979”. The following settings can be programmed:

Require Add-On Code: All EAN-13 barcodes that begin with “979” must have a 2-digit or 5-digit add-on code. The EAN-13 barcode with the add-on code is then transmitted. If the required add-on code is not found, the EAN-13 barcode is discarded.

Do Not Require Add-On Code: If you have selected **Require Add-On Code**, and you want to disable this feature, scan **Do Not Require Add-On Code**. EAN-13 barcodes are handled, depending on your selection for the “Add-On Code Required” feature.



@E139790

**** Do Not Require Add-On Code**



@E139791

Require Add-On Code

UPC-E

Restore Factory Defaults



@LPEDEF

Restore the Factory Defaults of UPC-E

Enable/Disable UPC-E



@UPEENAI

**** Enable UPC-E**



@UPEENAO

Disable UPC-E

Transmit Check Character

UPC-E is 8 digits in length with the last one as its check character used to verify the integrity of the data.



@UPECHK2

** Transmit UPC-E Check Character



@UPECHK1

Do Not Transmit UPC-E Check Character

2-Digit Add-On Code

A UPC-E barcode can be augmented with a two-digit add-on code to form a new one. In the example below, the part surrounded by blue dotted line is a UPC-E barcode while the part circled by red dotted line is a two-digit add-on code.



@UPEAD20

** Disable 2-Digit Add-On Code



@UPEAD21

Enable 2-Digit Add-On Code



Disable 2-Digit Add-On Code: The scanner decodes UPC-E and ignores the add-on code when presented with a UPC-E plus 2-digit add-on barcode. It can also decode UPC-E barcodes without 2-digit add-on codes.

Enable 2-Digit Add-On Code: The scanner decodes a mix of UPC-E barcodes with and without 2-digit add-on codes.

5-Digit Add-On Code

A UPC-E barcode can be augmented with a five-digit add-on code to form a new one. In the example below, the part surrounded by blue dotted line is a UPC-E barcode while the part circled by red dotted line is a five-digit add-on code.



@UPEAD50

** Disable 5-Digit Add-On Code



@UPEAD51

Enable 5-Digit Add-On Code



Disable 5-Digit Add-On Code: The scanner decodes UPC-E and ignores the add-on code when presented with a UPC-E plus 5-digit add-on barcode. It can also decode UPC-E barcodes without 5-digit add-on codes.

Enable 5-Digit Add-On Code: The scanner decodes a mix of UPC-E barcodes with and without 5-digit add-on codes.

Add-On Code Required

When **UPC-E Add-On Code Required** is selected, the scanner will only read UPC-E barcodes that contain add-on codes.



@UPEREQ1

UPC-E Add-On Code Required



@UPEREQ0

**** UPC-E Add-On Code Not Required**

Add-On Code Separator

When this feature is on, there is a space between the data from the barcode and the data from the add-on code. When turned off, there is no space.



@UPESEPO

**** Off**



@UPESEPI

On

Transmit Preamble Character

Preamble characters (Country Code and System Character) can be transmitted as part of a UPC-E barcode. Select one of the following options for transmitting UPC-E preamble to the host device: transmit system character only, transmit system character and country code ("0" for USA), or transmit no preamble.



@UPEPRE1

**** System Character**



@UPEPRE0

No Preamble



@UPEPRE2

System Character & Country Code

Convert UPC-E to UPC-A

Convert UPC-E to UPC-A: Convert UPC-E decoded data to UPC-A format before transmission. After conversion, the data follows UPC-A format and is affected by UPC-A programming selections (e.g., Preamble, Check Character).

Do Not Convert UPC-E to UPC-A: UPC-E decoded data is transmitted as UPC-E data, without conversion.



@UPEEXP0

**** Do Not Convert UPC-E to UPC-A**



@UPEEXP1

Convert UPC-E to UPC-A

UPC-A

Restore Factory Defaults



@UPADEF

Restore the Factory Defaults of UPC-A

Enable/Disable UPC-A



@UPAENA1

**** Enable UPC-A**



@UPAENA0

Disable UPC-A



If the scanner fails to identify UPC-A barcodes, you may first try this solution by scanning the **Enable UPC-A** barcode.

Transmit Check Character

UPC-A is 13 digits in length with the last one as its check character used to verify the integrity of the data.



@UPACHK2

**** Transmit UPC-A Check Character**



@UPACHK1

Do Not Transmit UPC-A Check Character

2-Digit Add-On Code

A UPC-A barcode can be augmented with a two-digit add-on code to form a new one. In the example below, the part surrounded by blue dotted line is a UPC-A barcode while the part circled by red dotted line is a two-digit add-on code.



@UPAAD20

**** Disable 2-Digit Add-On Code**



@UPAAD21

Enable 2-Digit Add-On Code



Disable 2-Digit Add-On Code: The scanner decodes UPC-A and ignores the add-on code when presented with a UPC-A plus 2-digit add-on barcode. It can also decode UPC-A barcodes without 2-digit add-on codes.

Enable 2-Digit Add-On Code: The scanner decodes a mix of UPC-A barcodes with and without 2-digit add-on codes.

5-Digit Add-On Code

A UPC-A barcode can be augmented with a five-digit add-on code to form a new one. In the example below, the part surrounded by blue dotted line is a UPC-A barcode while the part circled by red dotted line is a five-digit add-on code.



@UPAAD50

**** Disable 5-Digit Add-On Code**



@UPAAD51

Enable 5-Digit Add-On Code



Disable 5-Digit Add-On Code: The scanner decodes UPC-A and ignores the add-on code when presented with a UPC-A plus 5-digit add-on barcode. It can also decode UPC-A barcodes without 5-digit add-on codes.

Enable 5-Digit Add-On Code: The scanner decodes a mix of UPC-A barcodes with and without 5-digit add-on codes.

Add-On Code Required

When **UPC-A Add-On Code Required** is selected, the scanner will only read UPC-A barcodes that contain add-on codes.



@UPAREQ1

UPC-A Add-On Code Required



@UPAREQ0

**** UPC-A Add-On Code Not Required**

Add-On Code Separator

When this feature is on, there is a space between the data from the barcode and the data from the add-on code. When turned off, there is no space.



@UPASEP0

**** Off**



@UPASEP1

On

Transmit Preamble Character

Preamble characters (Country Code and System Character) can be transmitted as part of a UPC-A barcode. Select one of the following options for transmitting UPC-A preamble to the host device: transmit system character only, transmit system character and country code ("0" for USA), or transmit no preamble.



@UPAPRE0

No Preamble



@UPAPRE1

**** System Character**



@UPAPRE2

System Character & Country Code

Interleaved 2 of 5

Restore Factory Defaults



@I25DEF

Restore the Factory Defaults of Interleaved 2 of 5

Enable/Disable Interleaved 2 of 5



@I25ENA1

**** Enable Interleaved 2 of 5**



@I25ENA0

Disable Interleaved 2 of 5



If the scanner fails to identify Interleaved 2 of 5 barcodes, you may first try this solution by scanning the **Enable Interleaved 2 of 5** barcode.

Set Length Range for Interleaved 2 of 5

The scanner can be configured to only decode Interleaved 2 of 5 barcodes with lengths that fall between (inclusive) the minimum and maximum lengths. To accomplish it, you need to set the minimum and maximum lengths.



@I25MIN

Set the Minimum Length (Default: 6)



@I25MAX

Set the Maximum Length (Default: 80)



If minimum length is set to be greater than maximum length, the scanner only decodes Interleaved 2 of 5 barcodes with either the minimum or maximum length. If minimum length is same as maximum length, only Interleaved 2 of 5 barcodes with that length are to be decoded.

Example

Set the scanner to decode Interleaved 2 of 5 barcodes containing between 8 and 12 characters:

1. Scan the **Set the Minimum Length** barcode.
2. Scan the numeric barcode "8" from the "Digit Barcodes" section in Appendix.
3. Scan the **Save** barcode from the "Save/Cancel Barcodes" section in Appendix.
4. Scan the **Set the Maximum Length** barcode.
5. Scan the numeric barcodes "1" and "2" from the "Digit Barcodes" section in Appendix.

-
6. Scan the **Save** barcode from the “Save/Cancel Barcodes” section in Appendix.

Check Character Verification

A check character is optional for Interleaved 2 of 5 and can be added as the last character. It is a calculated value used to verify the integrity of the data.

- ✧ **Disable:** The scanner transmits Interleaved 2 of 5 barcodes as is.
- ✧ **Do Not Transmit Check Character After Verification:** The scanner checks the integrity of all Interleaved 2 of 5 barcodes to verify that the data complies with the check character algorithm. Barcodes passing the check will be transmitted except the last digit, whereas those failing it will not be transmitted.
- ✧ **Transmit Check Character After Verification:** The scanner checks the integrity of all Interleaved 2 of 5 barcodes to verify that the data complies with the check character algorithm. Barcodes passing the check will be transmitted, whereas those failing it will not be transmitted.

Since Interleaved 2 of 5 must always have an even number of digits, a zero may need to be added as the first digit when the check character is added. The check character is automatically generated when making Interleaved 2 of 5 barcodes.



@I25CHK0

**** Disable**



@I25CHK1

**Do Not Transmit Check Character After
Verification**



@I25CHK2

**Transmit Check Character After
Verification**



If the **Do Not Transmit Check Character After Verification** option is enabled, Interleaved 2 of 5 barcodes with a length that is less than the configured minimum length after having the check character excluded will not be decoded. (For example, when the **Do Not Transmit Check Character After Verification** option is enabled and the minimum length is set to 4, Interleaved 2 of 5 barcodes with a total length of 4 characters including the check character cannot be read.)

ITF-14

ITF-14 is a special kind of Interleaved 2 of 5 with a length of 14 characters and the last character as the check character.

ITF-14 priority principle: For the Interleaved 2 of 5 barcodes with a length of 14 characters and the last character as the check character, the ITF-14 configurations shall take precedence over the Interleaved 2 of 5 settings.

Restore Factory Defaults



@I14DEF

Restore the Factory Defaults of ITF-14

Enable/Disable ITF-14



@I14ENA0

**** Disable ITF-14**



@I14ENA1

Enable ITF-14 But Do Not Transmit Check Character



@I14ENA2

Enable ITF-14 and Transmit Check Character



An example of the ITF-14 priority principle: when ITF-14 is enabled and Interleaved 2 of 5 is disabled, the scanner only decodes Interleaved 2 of 5 barcodes with a length of 14 characters and the last character as the check character.

ITF-6

ITF-6 is a special kind of Interleaved 2 of 5 with a length of 6 characters and the last character as the check character.

ITF-6 priority principle: For the Interleaved 2 of 5 barcodes with a length of 6 characters and the last character as the check character, the ITF-6 configurations shall take precedence over the Interleaved 2 of 5 settings.

Restore Factory Defaults



@IT6DEF

Restore the Factory Defaults of ITF-6

Enable/Disable ITF-6



@IT6ENAO

**** Disable ITF-6**



@IT6ENA1

Enable ITF-6 But Do Not Transmit Check Character



@IT6ENA2

Enable ITF-6 and Transmit Check Character



An example of the ITF-6 priority principle: when ITF-6 is enabled and Interleaved 2 of 5 is disabled, the scanner only decodes Interleaved 2 of 5 barcodes with a length of 6 characters and the last character as the check character.

Matrix 2 of 5

Restore Factory Defaults



@M25DEF

Restore the Factory Defaults of Matrix 2 of 5

Enable/Disable Matrix 2 of 5



@M25ENA1

**** Enable Matrix 2 of 5**



@M25ENA0

Disable Matrix 2 of 5



If the scanner fails to identify Matrix 2 of 5 barcodes, you may first try this solution by scanning the **Enable Matrix 2 of 5** barcode.

Set Length Range for Matrix 2 of 5

The scanner can be configured to only decode Matrix 2 of 5 barcodes with lengths that fall between (inclusive) the minimum and maximum lengths. To accomplish it, you need to set the minimum and maximum lengths.



@M25MIN

Set the Minimum Length (Default: 4)



@M25MAX

Set the Maximum Length (Default: 80)



If minimum length is set to be greater than maximum length, the scanner only decodes Matrix 2 of 5 barcodes with either the minimum or maximum length. If minimum length is same as maximum length, only Matrix 2 of 5 barcodes with that length are to be decoded.



Set the scanner to decode Matrix 2 of 5 barcodes containing between 8 and 12 characters:

1. Scan the **Set the Minimum Length** barcode.
2. Scan the numeric barcode "8" from the "Digit Barcodes" section in Appendix.
3. Scan the **Save** barcode from the "Save/Cancel Barcodes" section in Appendix.
4. Scan the **Set the Maximum Length** barcode.
5. Scan the numeric barcodes "1" and "2" from the "Digit Barcodes" section in Appendix.
6. Scan the **Save** barcode from the "Save/Cancel Barcodes" section in Appendix.

Check Character Verification

A check character is optional for Matrix 2 of 5 and can be added as the last character. It is a calculated value used to verify the integrity of the data.

- ✧ **Disable:** The scanner transmits Matrix 2 of 5 barcodes as is.
- ✧ **Do Not Transmit Check Character After Verification:** The scanner checks the integrity of all Matrix 2 of 5 barcodes to verify that the data complies with the check character algorithm. Barcodes passing the check will be transmitted except the last digit, whereas those failing it will not be transmitted.
- ✧ **Transmit Check Character After Verification:** The scanner checks the integrity of all Matrix 2 of 5 barcodes to verify that the data complies with the check character algorithm. Barcodes passing the check will be transmitted, whereas those failing it will not be transmitted.

Since Matrix 2 of 5 must always have an even number of digits, a zero may need to be added as the first digit when the check character is added. The check character is automatically generated when making Matrix 2 of 5 barcodes.



@M25CHK0

**** Disable**



@M25CHK1

**Do Not Transmit Check Character After
Verification**



@M25CHK2

Transmit Check Character After Verification



If the **Do Not Transmit Check Character After Verification** option is enabled, Matrix 2 of 5 barcodes with a length that is less than the configured minimum length after having the check character excluded will not be decoded. (For example, when the **Do Not Transmit Check Character After Verification** option is enabled and the minimum length is set to 4, Matrix 2 of 5 barcodes with a total length of 4 characters including the check character cannot be read.)

Code 39

Restore Factory Defaults



@C39DEF

Restore the Factory Defaults of Code 39

Enable/Disable Code 39



@C39ENA1

**** Enable Code 39**



@C39ENA0

Disable Code 39



If the scanner fails to identify Code 39 barcodes, you may first try this solution by scanning the **Enable Code 39** barcode.

Set Length Range for Code 39

The scanner can be configured to only decode Code 39 barcodes with lengths that fall between (inclusive) the minimum and maximum lengths. To accomplish it, you need to set the minimum and maximum lengths.



@C39MIN

Set the Minimum Length (Default: 1)



@C39MAX

Set the Maximum Length (Default: 48)



If minimum length is set to be greater than maximum length, the scanner only decodes Code 39 barcodes with either the minimum or maximum length. If minimum length is same as maximum length, only Code 39 barcodes with that length are to be decoded.



Set the scanner to decode Code 39 barcodes containing between 8 and 12 characters:

1. Scan the **Set the Minimum Length** barcode.
2. Scan the numeric barcode "8" from the "Digit Barcodes" section in Appendix.
3. Scan the **Save** barcode from the "Save/Cancel Barcodes" section in Appendix.
4. Scan the **Set the Maximum Length** barcode.
5. Scan the numeric barcodes "1" and "2" from the "Digit Barcodes" section in Appendix.
6. Scan the **Save** barcode from the "Save/Cancel Barcodes" section in Appendix.

Check Character Verification

A check character is optional for Code 39 and can be added as the last character. It is a calculated value used to verify the integrity of the data.

- ✧ **Disable:** The scanner transmits Code 39 barcodes as is.
- ✧ **Do Not Transmit Check Character After Verification:** The scanner checks the integrity of all Code 39 barcodes to verify that the data complies with the check character algorithm. Barcodes passing the check will be transmitted except the last digit, whereas those failing it will not be transmitted.
- ✧ **Transmit Check Character After Verification:** The scanner checks the integrity of all Code 39 barcodes to verify that the data complies with the check character algorithm. Barcodes passing the check will be transmitted, whereas those failing it will not be transmitted.



@C39CHK0

**** Disable**



@C39CHK1

Do Not Transmit Check Character After Verification



@C39CHK2

Transmit Check Character After Verification



If the **Do Not Transmit Check Character After Verification** option is enabled, Code 39 barcodes with a length that is less than the configured minimum length after having the check character excluded will not be decoded. (For example, when the **Do Not Transmit**

Check Character After Verification option is enabled and the minimum length is set to 4, Code 39 barcodes with a total length of 4 characters including the check character cannot be read.)

Transmit Start/Stop Character

Code 39 uses an asterisk (*) for both the start and the stop characters. You can choose whether or not to transmit the start/stop characters by scanning the appropriate barcode below.



@C39TSC0

**** Do Not Transmit Start/Stop Character**



@C39TSC1

Transmit Start/Stop Character

Enable/Disable Code 39 Full ASCII

The scanner can be configured to identify all ASCII characters by scanning the appropriate barcode below.



@C39ASC0

**** Disable Code 39 Full ASCII**



@C39ASC1

Enable Code 39 Full ASCII

Codabar

Restore Factory Defaults



@CBADEF

Restore the Factory Defaults of Codabar

Enable/Disable Codabar



@CBAENA1

**** Enable Codabar**



@CBAENA0

Disable Codabar



If the scanner fails to identify Codabar barcodes, you may first try this solution by scanning the **Enable Codabar** barcode.

Set Length Range for Codabar

The scanner can be configured to only decode Codabar barcodes with lengths that fall between (inclusive) the minimum and maximum lengths. To accomplish it, you need to set the minimum and maximum lengths.



@CBAMIN

Set the Minimum Length (Default: 2)



@CBAMAX

Set the Maximum Length (Default: 60)



If minimum length is set to be greater than maximum length, the scanner only decodes Codabar barcodes with either the minimum or maximum length. If minimum length is same as maximum length, only Codabar barcodes with that length are to be decoded.



Set the scanner to decode Codabar barcodes containing between 8 and 12 characters:

1. Scan the **Set the Minimum Length** barcode.
2. Scan the numeric barcode "8" from the "Digit Barcodes" section in Appendix.
3. Scan the **Save** barcode from the "Save/Cancel Barcodes" section in Appendix.
4. Scan the **Set the Maximum Length** barcode.
5. Scan the numeric barcodes "1" and "2" from the "Digit Barcodes" section in Appendix.
6. Scan the **Save** barcode from the "Save/Cancel Barcodes" section in Appendix.

Check Character Verification

A check character is optional for Codabar and can be added as the last character. It is a calculated value used to verify the integrity of the data.

- ✧ **Disable:** The scanner transmits Codabar barcodes as is.
- ✧ **Do Not Transmit Check Character After Verification:** The scanner checks the integrity of all Codabar barcodes to verify that the data complies with the check character algorithm. Barcodes passing the check will be transmitted except the last digit, whereas those failing it will not be transmitted.
- ✧ **Transmit Check Character After Verification:** The scanner checks the integrity of all Codabar barcodes to verify that the data complies with the check character algorithm. Barcodes passing the check will be transmitted, whereas those failing it will not be transmitted.



@CBACHK0

**** Disable**



@CBACHK1

Do Not Transmit Check Character After Verification



@CBACHK2

Transmit Check Character After Verification



If the **Do Not Transmit Check Character After Verification** option is enabled, Codabar barcodes with a length that is less than the configured minimum length after having the check character excluded will not be decoded. (For example, when the **Do Not Transmit**

Check Character After Verification option is enabled and the minimum length is set to 4, Codabar barcodes with a total length of 4 characters including the check character cannot be read.)

Start/Stop Character

You can set the start/stop characters and choose whether or not to transmit the start/stop characters by scanning the appropriate barcode below.



@CBATSC0

**** Do Not Transmit Start/Stop Character**



@CBATSC1

Transmit Start/Stop Character



@CBASCF0

**** ABCD/ABCD as the Start/Stop Character**



@CBASCF1

ABCD/TN*E as the Start/Stop Character



@CBASCF2

abcd/abcd as the Start/Stop Character



@CBASCF3

abcd/tn*e as the Start/Stop Character

Code 93

Restore Factory Defaults



@C93DEF

Restore the Factory Defaults of Code 93

Enable/Disable Code 93



@C93ENA1

Enable Code 93



@C93ENA0

**** Disable Code 93**



If the scanner fails to identify Code 93 barcodes, you may first try this solution by scanning the **Enable Code 93** barcode.

Set Length Range for Code 93

The scanner can be configured to only decode Code 93 barcodes with lengths that fall between (inclusive) the minimum and maximum lengths. To accomplish it, you need to set the minimum and maximum lengths.



@C93MIN

Set the Minimum Length (Default: 1)



@C93MAX

Set the Maximum Length (Default: 48)



If minimum length is set to be greater than maximum length, the scanner only decodes Code 93 barcodes with either the minimum or maximum length. If minimum length is same as maximum length, only Code 93 barcodes with that length are to be decoded.



Set the scanner to decode Code 93 barcodes containing between 8 and 12 characters:

1. Scan the **Set the Minimum Length** barcode.
2. Scan the numeric barcode "8" from the "Digit Barcodes" section in Appendix.
3. Scan the **Save** barcode from the "Save/Cancel Barcodes" section in Appendix.
4. Scan the **Set the Maximum Length** barcode.
5. Scan the numeric barcodes "1" and "2" from the "Digit Barcodes" section in Appendix.
6. Scan the **Save** barcode from the "Save/Cancel Barcodes" section in Appendix.

Check Character Verification

Check characters are optional for Code 93 and can be added as the last two characters, which are calculated values used to verify the integrity of the data.

- ✧ **Disable:** The scanner transmits Code 93 barcodes as is.
- ✧ **Do Not Transmit Check Character After Verification:** The scanner checks the integrity of all Code 93 barcodes to verify that the data complies with the check character algorithm. Barcodes passing the checks will be transmitted except the last two digits, whereas those failing them will not be transmitted.
- ✧ **Transmit Check Character After Verification:** The scanner checks the integrity of all Code 93 barcodes to verify that the data complies with the check character algorithm. Barcodes passing the checks will be transmitted, whereas those failing them will not be transmitted.



@C93CHK0

Disable



@C93CHK1

**** Do Not Transmit Check Character After Verification**



@C93CHK2

Transmit Check Character After Verification



If the **Do Not Transmit Check Character After Verification** option is enabled, Code 93 barcodes with a length that is less than the configured minimum length after having the two check characters excluded will not be decoded. (For example, when the **Do Not Transmit**

Check Character After Verification option is enabled and the minimum length is set to 4, Code 93 barcodes with a total length of 4 characters including the two check characters cannot be read.

GS1-128 (UCC/EAN-128)

Restore Factory Defaults



@GSIDF

Restore the Factory Defaults of GS1-128

Enable/Disable GS1-128



@GS1ENAI

**** Enable GS1-128**



@GS1ENAO

Disable GS1-128



If the scanner fails to identify GS1-128 barcodes, you may first try this solution by scanning the **Enable GS1-128** barcode.

AIM 128

Restore Factory Defaults



@AIMDEF

Restore the Factory Defaults of AIM 128

Enable/Disable AIM 128



@AIMENA1

Enable AIM128



@AIMENA0

**** Disable AIM 128**



If the scanner fails to identify AIM 128 barcodes, you may first try this solution by scanning the

Enable AIM 128 barcode.

Set Length Range for AIM 128

The scanner can be configured to only decode AIM 128 barcodes with lengths that fall between (inclusive) the minimum and maximum lengths. To accomplish it, you need to set the minimum and maximum lengths.



@AIMMIN

Set the Minimum Length (Default: 1)



@AIMMAX

Set the Maximum Length (Default: 48)



If minimum length is set to be greater than maximum length, the scanner only decodes GS1-128 barcodes with either the minimum or maximum length. If minimum length is same as maximum length, only GS1-128 barcodes with that length are to be decoded.

E
xample

Set the scanner to decode AIM 128 barcodes containing between 8 and 12 characters:

1. Scan the **Set the Minimum Length** barcode.
2. Scan the numeric barcode "8" from the "Digit Barcodes" section in Appendix.
3. Scan the **Save** barcode from the "Save/Cancel Barcodes" section in Appendix.
4. Scan the **Set the Maximum Length** barcode.
5. Scan the numeric barcodes "1" and "2" from the "Digit Barcodes" section in Appendix.

6. Scan the **Save** barcode from the “Save/Cancel Barcodes” section in Appendix.

ISBT 128

Restore Factory Defaults



@IBTDEF

Restore the Factory Defaults of ISBT 128

Enable/Disable ISBT 128



@IBTENAI

Enable ISBT 128



@IBTENA0

**** Disable ISBT 128**



If the scanner fails to identify ISBT-128 barcodes, you may first try this solution by scanning the **Enable ISBT-128** barcode.

Code 11

Restore Factory Defaults



@C11DEF

Restore the Factory Defaults of Code 11

Enable/Disable Code 11



@C11ENAI

Enable Code 11



@C11ENA0

**** Disable Code 11**



If the scanner fails to identify Code 11 barcodes, you may first try this solution by scanning the **Enter Setup** barcode and then **Enable Code 11** barcode.

Set Length Range for Code 11

The scanner can be configured to only decode Code 11 barcodes with lengths that fall between (inclusive) the minimum and maximum lengths. To accomplish it, you need to set the minimum and maximum lengths.



@C11MIN

Set the Minimum Length (Default: 4)



@C11MAX

Set the Maximum Length (Default: 48)



If minimum length is set to be greater than maximum length, the scanner only decodes Code 11 barcodes with either the minimum or maximum length. If minimum length is same as maximum length, only Code 11 barcodes with that length are to be decoded.

Example

Set the scanner to decode Code 11 barcodes containing between 8 and 12 characters:

1. Scan the **Set the Minimum Length** barcode.
2. Scan the numeric barcode "8" from the "Digit Barcodes" section in Appendix.
3. Scan the **Save** barcode from the "Save/Cancel Barcodes" section in Appendix.
4. Scan the **Set the Maximum Length** barcode.
5. Scan the numeric barcodes "1" and "2" from the "Digit Barcodes" section in Appendix.
6. Scan the **Save** barcode from the "Save/Cancel Barcodes" section in Appendix.

Check Character Verification

Check characters are optional for Code 11 and can be added as the last one or two characters, which are calculated values used to verify the integrity of the data.

If the **Disable** option is enabled, the scanner transmits Code 11 barcodes as is.



@C11CHK0

Disable



@C11CHK1

**** One Check Character, MOD11**



@C11CHK2

Two Check Characters, MOD11/MOD11



@C11CHK3

Two Check Characters, MOD11/MOD9



@C11CHK4

One Check Character, MOD11 (Len<=10)

Two Check Characters, MOD11/MOD11(Len>10)



@C11CHK5

One Check Character, MOD11 (Len<=10)

Two Check Characters, MOD11/MOD9

(Len>10)

Transmit Check Character



@C11TCK0

Do Not Transmit Code 11 Check Character



@C11TCK1

** Transmit Code 11 Check Character



If you select a check character algorithm and the **Do Not Transmit Check Character** option, Code 11 barcodes with a length that is less than the configured minimum length after having the check character(s) excluded will not be decoded. (For example, when the **One Check Character, MOD11** and **Do Not Transmit Check Character** options are enabled and the minimum length is set to 4, Code 11 barcodes with a total length of 4 characters including the check character cannot be read.)

ISBN

Restore Factory Defaults



@ISBDEF

Restore the Factory Defaults of ISBN

Enable/Disable ISBN



@ISBENA1

Enable ISBN



@ISBENA0

**** Disable ISBN**

Set ISBN Format



@ISBT101

**** ISBN-10**



@ISBT100

ISBN-13

ISSN

Restore Factory Defaults



@ISSDEF

Restore the Factory Defaults of ISSN

Enable/Disable ISSN



@ISSENAI

Enable ISSN



@ISSENA0

**** Disable ISSN**

Industrial 2/5

Restore Factory Defaults



@L25DEF

Restore the Factory Defaults of Industrial 25

Enable/Disable Industrial 2/5



@L25ENA1

Enable Industrial 2/5



@L25ENA0

**** Disable Industrial 2/5**



If the scanner fails to identify Industrial 2/5 barcodes, you may first try this solution by scanning the **Enable Industrial 2/5** barcode.

Set Length Range for Industrial 25

The scanner can be configured to only decode Industrial 25 barcodes with lengths that fall between (inclusive) the minimum and maximum lengths. To accomplish it, you need to set the minimum and maximum lengths.



@L25MIN

Set the Minimum Length (Default: 6)



@L25MAX

Set the Maximum Length (Default: 48)



If minimum length is set to be greater than maximum length, the scanner only decodes Industrial 25 barcodes with either the minimum or maximum length. If minimum length is same as maximum length, only Industrial 25 barcodes with that length are to be decoded.

Example

Set the scanner to decode Industrial 25 barcodes containing between 8 and 12 characters:

1. Scan the **Set the Minimum Length** barcode.
2. Scan the numeric barcode "8" from the "Digit Barcodes" section in Appendix.
3. Scan the **Save** barcode from the "Save/Cancel Barcodes" section in Appendix.
4. Scan the **Set the Maximum Length** barcode.
5. Scan the numeric barcodes "1" and "2" from the "Digit Barcodes" section in Appendix.
6. Scan the **Save** barcode from the "Save/Cancel Barcodes" section in Appendix.

Check Character Verification

A check character is optional for Industrial 25 and can be added as the last character. It is a calculated value used to verify the integrity of the data.

- ✧ **Disable:** The scanner transmits Industrial 25 barcodes as is.
- ✧ **Do Not Transmit Check Character After Verification:** The scanner checks the integrity of all Industrial 25 barcodes to verify that the data complies with the check character algorithm. Barcodes passing the check will be transmitted except the last digit, whereas those failing it will not be transmitted.
- ✧ **Transmit Check Character After Verification:** The scanner checks the integrity of all Industrial 25 barcodes to verify that the data complies with the check character algorithm. Barcodes passing the check will be transmitted, whereas those failing it will not be transmitted.



@L25CHK0

**** Disable**



@L25CHK1

**Do Not Transmit Check Character After
Verification**



@L25CHK2

Transmit Check Character After Verification



If the **Do Not Transmit Check Character After Verification** option is enabled, Industrial 25 barcodes with a length that is less than the configured minimum length after having the check character excluded will not be decoded. (For example, when the **Do Not Transmit**

Check Character After Verification option is enabled and the minimum length is set to 4, Industrial 25 barcodes with a total length of 4 characters including the check character cannot be read.)

Standard 2/5

Restore Factory Defaults



@S25DEF

Restore the Factory Defaults of Standard 25

Enable/Disable Standard 2/5



@S25ENA1

Enable Standard 25



@S25ENA0

**** Disable Standard 25**



If the scanner fails to identify Standard 25 barcodes, you may first try this solution by scanning the **Enable Standard 25** barcode.

Set Length Range for Standard 25

The scanner can be configured to only decode Standard 25 barcodes with lengths that fall between (inclusive) the minimum and maximum lengths. To accomplish it, you need to set the minimum and maximum lengths.



@S25MIN

Set the Minimum Length (Default: 6)



@S25MAX

Set the Maximum Length (Default: 48)



If minimum length is set to be greater than maximum length, the scanner only decodes Standard 25 barcodes with either the minimum or maximum length. If minimum length is same as maximum length, only Standard 25 barcodes with that length are to be decoded.



Set the scanner to decode Standard 25 barcodes containing between 8 and 12 characters:

1. Scan the **Set the Minimum Length** barcode.
2. Scan the numeric barcode "8" from the "Digit Barcodes" section in Appendix.
3. Scan the **Save** barcode from the "Save/Cancel Barcodes" section in Appendix.
4. Scan the **Set the Maximum Length** barcode.
5. Scan the numeric barcodes "1" and "2" from the "Digit Barcodes" section in Appendix.
6. Scan the **Save** barcode from the "Save/Cancel Barcodes" section in Appendix.

Check Character Verification

A check character is optional for Standard 25 and can be added as the last character. It is a calculated value used to verify the integrity of the data.

- ◇ **Disable:** The scanner transmits Standard 25 barcodes as is.
- ◇ **Do Not Transmit Check Character After Verification:** The scanner checks the integrity of all Standard 25 barcodes to verify that the data complies with the check character algorithm. Barcodes passing the check will be transmitted except the last digit, whereas those failing it will not be transmitted.
- ◇ **Transmit Check Character After Verification:** The scanner checks the integrity of all Standard 25 barcodes to verify that the data complies with the check character algorithm. Barcodes passing the check will be transmitted, whereas those failing it will not be transmitted.



@S25CHK0

**** Disable**



@S25CHK1

**Do Not Transmit Check Character After
Verification**



@S25CHK2

**Transmit Check Character After
Verification**



If the **Do Not Transmit Check Character After Verification** option is enabled, Standard 25 barcodes with a length that is less than the configured minimum length after having the

check character excluded will not be decoded. (For example, when the **Do Not Transmit Check Character After Verification** option is enabled and the minimum length is set to 4, Standard 25 barcodes with a total length of 4 characters including the check character cannot be read.)

COOP 25

Restore Factory Defaults



@COPDEF

Restore the Factory Defaults of COOP 25

Enable/Disable COOP 25



@COPENA1

Enable COOP 25



@COPENA0

****Disable COOP 25**

Set Length Range for COOP 25

The scanner can be configured to only decode COOP 25 barcodes with lengths that fall between (inclusive) the minimum and maximum lengths. To accomplish it, you need to set the minimum and maximum lengths.



@COPMIN

Set the Minimum Length (Default: 1)



@PLYMAX

Set the Maximum Length (Default: 48)



If minimum length is set to be greater than maximum length, the scanner only decodes COOP 25 barcodes with either the minimum or maximum length. If minimum length is same as maximum length, only COOP 25 barcodes with that length are to be decoded.



Set the scanner to decode COOP 25 barcodes containing between 8 and 12 characters:

1. Scan the **Set the Minimum Length** barcode.
2. Scan the numeric barcode "8" from the "Digit Barcodes" section in Appendix.
3. Scan the **Save** barcode from the "Save/Cancel Barcodes" section in Appendix.
4. Scan the **Set the Maximum Length** barcode.
5. Scan the numeric barcodes "1" and "2" from the "Digit Barcodes" section in Appendix.
6. Scan the **Save** barcode from the "Save/Cancel Barcodes" section in Appendix.

Check Character Verification

A check character is optional for COOP 25 and can be added as the last character. It is a calculated value used to verify the integrity of the data.

- ✧ **Disable:** The scanner transmits COOP 25 barcodes as is.
- ✧ **Enable But Do Not Transmit Check Character:** The scanner checks the integrity of all COOP 25 barcodes to verify that the data complies with the check character algorithm. Barcodes passing the check will be transmitted except the last digit, whereas those failing it will not be transmitted.
- ✧ **Enable And Transmit Check Character:** The scanner checks the integrity of all COOP 25 barcodes to verify that the data complies with the check character algorithm. Barcodes passing the check will be transmitted, whereas those failing it will not be transmitted.



@COPCHK0

**** Disable**



@COPCHK1

Enable But Do Not Transmit Check Character



@COPCHK2

**Transmit Check Character After
Verification**

Deutsche 14

Restore Factory Defaults



@D14DEF

Restore the Factory Defaults of Deutsche 14

Enable/Disable Deutsche 14



@D14ENA1

**Enable Deutsche 14 But Do Not Transmit
Check Digit**



@D14ENA2

**Enable Deutsche 14 and Transmit Check
Digit**



@D14ENA0

****Disable**

Deutsche 12

Restore Factory Defaults



@D12DEF

Restore the Factory Defaults of Deutsche 12

Enable/Disable Deutsche 12



@D12ENA1

**Enable Deutsche 12 But Do Not Transmit
Check Digit**



@D12ENA2

**Enable Deutsche 12 and Transmit Check
Digit**



@D12ENA0

****Disable**

Plessey

Restore Factory Defaults



@PLYDEF

Restore the Factory Defaults of Plessey

Enable/Disable Plessey



@PLYENA1

Enable Plessey



@PLYENA0

**** Disable Plessey**



If the scanner fails to identify Plessey barcodes, you may first try this solution by scanning

the **Enable Plessey** barcode.

Set Length Range for Plessey

The scanner can be configured to only decode Plessey barcodes with lengths that fall between (inclusive) the minimum and maximum lengths. To accomplish it, you need to set the minimum and maximum lengths.



@PLYMIN

Set the Minimum Length (Default: 4)



@PLYMAX

Set the Maximum Length (Default: 48)



If minimum length is set to be greater than maximum length, the scanner only decodes Plessey barcodes with either the minimum or maximum length. If minimum length is same as maximum length, only Plessey barcodes with that length are to be decoded.



Set the scanner to decode Plessey barcodes containing between 8 and 12 characters:

1. Scan the **Set the Minimum Length** barcode.
2. Scan the numeric barcode "8" from the "Digit Barcodes" section in Appendix.
3. Scan the **Save** barcode from the "Save/Cancel Barcodes" section in Appendix.
4. Scan the **Set the Maximum Length** barcode.
5. Scan the numeric barcodes "1" and "2" from the "Digit Barcodes" section in Appendix.
6. Scan the **Save** barcode from the "Save/Cancel Barcodes" section in Appendix.

Check Character Verification

Check characters are optional for Plessey and can be added as the last two characters, which are calculated values used to verify the integrity of the data.

- ✧ **Disable:** The scanner transmits Plessey barcodes as is.
- ✧ **Do Not Transmit Check Character After Verification:** The scanner checks the integrity of all Plessey barcodes to verify that the data complies with the check character algorithm. Barcodes passing the checks will be transmitted except the last two digits, whereas those failing them will not be transmitted.
- ✧ **Transmit Check Character After Verification:** The scanner checks the integrity of all Plessey barcodes to verify that the data complies with the check character algorithm. Barcodes passing the checks will be transmitted, whereas those failing them will not be transmitted.



@PLYCHK0

**** Disable**



@PLYCHK1

Do Not Transmit Check Character After Verification



@PLYCHK2

Transmit Check Character After Verification



If the **Do Not Transmit Check Character After Verification** option is enabled, Plessey barcodes with a length that is less than the configured minimum length after having the check characters excluded will not be decoded. (For example, when the **Do Not Transmit Check Character After Verification** option is enabled and the minimum length is set to 4,

Plessey barcodes with a total length of 4 characters including the check characters cannot be read.)

MSI-Plessey

Restore Factory Defaults



@MSIDF

Restore the Factory Defaults of MSI-Plessey

Enable/Disable MSI-Plessey



@MSIENAI

Enable MSI-Plessey



@MSIENAO

**** Disable MSI-Plessey**



If the scanner fails to identify MSI-Plessey barcodes, you may first try this solution by scanning the **Enable MSI-Plessey** barcode.

Set Length Range for MSI-Plessey

The scanner can be configured to only decode MSI-Plessey barcodes with lengths that fall between (inclusive) the minimum and maximum lengths. To accomplish it, you need to set the minimum and maximum lengths.



@MSIMIN

Set the Minimum Length (Default: 4)



@MSIMAX

Set the Maximum Length (Default: 48)



If minimum length is set to be greater than maximum length, the scanner only decodes MSI-Plessey barcodes with either the minimum or maximum length. If minimum length is same as maximum length, only MSI-Plessey barcodes with that length are to be decoded.



Set the scanner to decode MSI-Plessey barcodes containing between 8 and 12 characters:

1. Scan the **Set the Minimum Length** barcode.
2. Scan the numeric barcode "8" from the "Digit Barcodes" section in Appendix.
3. Scan the **Save** barcode from the "Save/Cancel Barcodes" section in Appendix.
4. Scan the **Set the Maximum Length** barcode.
5. Scan the numeric barcodes "1" and "2" from the "Digit Barcodes" section in Appendix.
6. Scan the **Save** barcode from the "Save/Cancel Barcodes" section in Appendix.

Check Character Verification

Check characters are optional for MSI-Plessey and can be added as the last one or two characters, which are calculated values used to verify the integrity of the data.

If the **Disable** option is enabled, the scanner transmits MSI-Plessey barcodes as is.



@MSICLK0

Disable



@MSICLK1

**** One Check Character, MOD10**



@MSICLK2

Two Check Characters, MOD10/MOD10



@MSICLK3

Two Check Characters, MOD10/MOD11

Transmit Check Character



@MSITCK1

** Transmit MSI-Plessey Check Character



@MSITCK0

Do Not Transmit MSI-Plessey Check Character



If you select a check character algorithm and the **Do Not Transmit Check Character** option, MSI-Plessey barcodes with a length that is less than the configured minimum length after having the check character(s) excluded will not be decoded. (For example, when the One Check Character, **MOD10** and **Do Not Transmit Check Character** options are enabled and the minimum length is set to 4, MSI-Plessey barcodes with a total length of 4 characters including the check character cannot be read.)

QR Code

Restore Factory Defaults



@QRCDEF

Restore the Factory Defaults of QR Code

Enable/Disable QR Code



@QRCENAI

**** Enable QR Code**



@QRCENA0

Disable QR Code



If the scanner fails to identify QR Code barcodes, you may first try this solution by scanning the **Enable QR Code** barcode.

Set Length Range for QR Code

The scanner can be configured to only decode QR Code barcodes with lengths that fall between (inclusive) the minimum and maximum lengths. To accomplish it, you need to set the minimum and maximum lengths.



@QRCMIN

Set the Minimum Length (Default: 1)



@QRCMAX

Set the Maximum Length (Default: 7089)



Minimum length is not allowed to be greater than maximum length. If you only want to read QR Code barcodes with a specific length, set both minimum and maximum lengths to be that desired length.

Example

Set the scanner to decode QR Code barcodes containing between 8 and 12 characters:

1. Scan the **Set the Minimum Length** barcode.
2. Scan the numeric barcode "8" from the "Digit Barcodes" section in Appendix.
3. Scan the **Save** barcode from the "Save/Cancel Barcodes" section in Appendix.
4. Scan the **Set the Maximum Length** barcode.
5. Scan the numeric barcodes "1" and "2" from the "Digit Barcodes" section in Appendix.
6. Scan the **Save** barcode from the "Save/Cancel Barcodes" section in Appendix.

QR Inverse

Regular barcode: Dark bars on a bright background.

Inverse barcode: Bright bars on a dark background.



@QRCINV0

Decode Regular QR Barcodes Only



@QRCINV2

**** Decode Both**

Character Encoding



@QRCENC0

**** Default Character Encoding**



@QRCECI

UTF-8

QR ECI Output



@QRCEI0

Disable QR ECI Output



@QRCEI1

**** Enable QR ECI Output**

QR Decoding Complexity

The Decoding Complexity parameter selects the decoding algorithm according to the printing/marking technique used to create the symbol and on the overall printing/marking quality.

- ◇ Low: For no stain, wrinkle and other high-quality barcodes;
- ◇ Medium: Bar code with general quality such as certain dirt, fold, etc;
- ◇ High: For Bar code with poor printing quality.



@CCFQRC0

Low



@CCFQRC2

High



@CCFQRC1

****Medium**

Continuous Code



@QRCMFE1

****On**



@QRCMFE0

off

Dot-peen Code



@QRCDFE1

****On**



@QRDFE0

Off

Mirror Code

For QR, when you have enabled Image Mirror, processes reverse printed or marked codes (mirrored images).



@QRCMRE0

Off



@QRCMRE1

****On**

QR Model 1

You can set disable and enable QR model 1 through the following setting code.



@QRCMIE0

Off



@QRCME1

****On**

QR Model 2

Model 2 of QR code is an improved version of model 1, which can also read data smoothly when the QR code is deformed. You can set disable and enable QR model 2 through the following setting code.



@QRCM2E0

****On**



@QRCM2E1

Off

Data Matrix

Restore Factory Defaults



@DMCDEF

Restore the Factory Defaults of Data Matrix

Enable/Disable Data Matrix



@DMCENAI

**** Enable Data Matrix**



@DMCENA0

Disable Data Matrix



If the scanner fails to identify Data Matrix barcodes, you may first try this solution by scanning the **Enable Data Matrix** barcode.

If the **Disable 2D Symbologies** feature is enabled, the Programming Barcode of 2D Data Matrix in this user guide will lose efficacy. It is recommended to use Setup Tool to reactive Data Matrix or scan these barcodes below.



#SETUPE1

Enter Setup



@DMCENA1

Enable Data Matrix

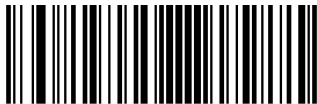

#SETUPE0

Exit Setup

Set Length Range for Data Matrix

The scanner can be configured to only decode Data Matrix barcodes with lengths that fall between (inclusive) the minimum and maximum lengths. To accomplish it, you need to set the minimum and maximum lengths.



@DMCMIN

Set the Minimum Length (Default: 1)



@DMCMAX

Set the Maximum Length (Default: 3116)



Minimum length is not allowed to be greater than maximum length. If you only want to read Data Matrix barcodes with a specific length, set both minimum and maximum lengths to be that desired length.

Example

Set the scanner to decode Data Matrix barcodes containing between 8 and 12 characters:

1. Scan the **Set the Minimum Length** barcode.
2. Scan the numeric barcode "8" from the "Digit Barcodes" section in Appendix.
3. Scan the **Save** barcode from the "Save/Cancel Barcodes" section in Appendix.
4. Scan the **Set the Maximum Length** barcode.
5. Scan the numeric barcodes "1" and "2" from the "Digit Barcodes" section in Appendix.
6. Scan the **Save** barcode from the "Save/Cancel Barcodes" section in Appendix.

Rectangular Barcode

Data Matrix has two formats:

Square barcodes having the same amount of modules in length and width: 10*10, 12*12... 144*144.

Rectangular barcodes having different amounts of models in length and width: 6*16, 6*14...14*22.



@DMCRECI

**** Enable Rectangular Barcode**



@DMCRECO

Disable Rectangular Barcode

Data Matrix Inverse

Regular barcode: Dark bars on a bright background.

Inverse barcode: Bright bars on a dark background.



@DMCINV0

Decode Regular Data Matrix Barcodes Only



@DMCINV2

**** Decode Both**

Character Encoding



@DMCENC0

**** Default Character Encoding**



@DMCENC1

UTF-8

Data Matrix ECI Output



@DMCEC10

Disable Data Matrix ECI Output



@DMCEC11

**** Enable Data Matrix ECI Output**

ECC200



@DMCE2E0

Off



@DMCE2E1

**** On**

ECC0T0140



@DMCE0E0

Off



@DMCE0E1

**** On**

DM Decoding Complexity

The Decoding Complexity parameter selects the decoding algorithm according to the printing/marketing technique used to create the symbol and on the overall printing/marketing quality.

- ✧ Low: For no stain, wrinkle and other high-quality barcodes;
- ✧ Medium: Bar code with general quality such as certain dirt, fold, etc;
- ✧ High: For Bar code with poor printing quality.



@CCFDMC0

Low



@CCFDMC1

Medium



@CCFDMC2

****High**

Continuous Code



@DMCMFE1

****On**



@DMCMFE0

Off

Dot-peen Code



@DMCDFE1

****On**



@DMCDFE0

Off

Mirror Code

For Data Matrix, when you have enabled Image Mirror, processes reverse printed or marked codes (mirrored images).



@DMCMRE0

Off



@DMCMRE1

****On**

PDF417

Restore Factory Defaults



@PDFDEF

Restore the Factory Defaults of PDF417

Enable/Disable PDF417



@PDFENAI

**** Enable PDF417**



@PDFENAO

Disable PDF417



If the scanner fails to identify PDF417 barcodes, you may first try this solution by scanning the **Enter Setup** barcode and then **Enable PDF417** barcode.

Set Length Range for PDF417

The scanner can be configured to only decode PDF417 barcodes with lengths that fall between (inclusive) the minimum and maximum lengths. To accomplish it, you need to set the minimum and maximum lengths.



@PDFMIN

Set the Minimum Length (Default: 1)



@PDFMAX

Set the Maximum Length (Default: 2710)



Minimum length is not allowed to be greater than maximum length. If you only want to read PDF417 barcodes with a specific length, set both minimum and maximum lengths to be that desired length.



Set the scanner to decode PDF417 barcodes containing between 8 and 12 characters:

1. Scan the **Set the Minimum Length** barcode.
2. Scan the numeric barcode "8" from the "Digit Barcodes" section in Appendix.
3. Scan the **Save** barcode from the "Save/Cancel Barcodes" section in Appendix.
4. Scan the **Set the Maximum Length** barcode.
5. Scan the numeric barcodes "1" and "2" from the "Digit Barcodes" section in Appendix.
6. Scan the **Save** barcode from the "Save/Cancel Barcodes" section in Appendix.

PDF417 Inverse

Regular barcode: Dark bars on a bright background.

Inverse barcode: Bright bars on a dark background.



@PDFINV0

Decode Regular PDF417 Barcodes Only



@PDFINV1

Decode Inverse PDF417 Barcodes Only



@PDFINV2

****Decode Both**

Character Encoding



@PDFENCO

**** Default Character Encoding**



@PDFENC1

UTF-8

Chapter 8 Prefix & Suffix

Introduction

A 1D barcode could contain digits, letters, symbols, etc. A 2D barcode could contain more data, such as Chinese characters and other multi-byte characters. However, in real applications, they do not and should not have all information we need, such as barcode type, data acquisition time and delimiter, in order to keep the barcodes short and flexible.

Prefix and suffix are how to fulfill the needs mentioned above. They can be added, removed and modified while the original barcode data remains intact.



Barcode processing procedure:

1. Edit data with Data Formatter
2. Append prefix/suffix
3. Pack data
4. Append terminating character

Global Settings

Enable/Disable All Prefixes/Suffixes

Disable All Prefixes/Suffixes: Transmit barcode data with no prefix/suffix.

Enable All Prefixes/Suffixes: Allow to append Code ID prefix, AIM ID prefix, custom prefix/suffix and terminating character to the barcode data before the transmission.



@APSENA0

Disable All Prefixes/Suffixes



@APSENA1

Enable All Prefixes/Suffixes

Prefix Sequence



@PRESEQ0

**** Code ID+ Custom +AIM ID**



@PRESEQ1

Custom + Code ID + AIM ID

Custom Prefix

Enable/Disable Custom Prefix

If custom prefix is enabled, you are allowed to append to the data a user-defined prefix that cannot exceed 10 characters. For example, if the custom prefix is "AB" and the barcode data is "123", the Host will receive "AB123".



@CPRENA0

**** Disable Custom Prefix**



@CPRENA1

Enable Custom Prefix

Set Custom Prefix

To set a custom prefix, scan the **Set Custom Prefix** barcode then the numeric barcodes corresponding to the hexadecimal value of a desired prefix then the **Save** barcode.

Note: A custom prefix cannot exceed 10 characters.



@CPRSET

Set Custom Prefix

E
sample

Set the custom prefix to "CODE" (HEX: 0x43/0x4F/0x44/0x45):

1. Scan the **Set Custom Prefix** barcode.

-
2. Scan the numeric barcodes "4", "3", "4", "F", "4", "4", "4" and "5" from the "Digit Barcodes" section in Appendix.
 3. Scan the **Save** barcode from the "Save/Cancel Barcodes" section in Appendix.
 4. Scan the **Enable Custom Prefix** barcode.

AIM ID Prefix

AIM (Automatic Identification Manufacturers) ID defines symbology identifier (For the details, see the "AIM ID Table" section in Appendix). If AIM ID prefix is enabled, the scanner will add the symbology identifier before the scanned data after decoding.



@AIDENAO

**** Disable AIM ID Prefix**



@AIDENA1

Enable AIM ID Prefix



AIM ID is not user programmable.

Code ID Prefix

Code ID can also be used to identify barcode type. Unlike AIM ID, Code ID is user programmable. Code ID can only consist of one or two English letters.



@CIDENA0

**** Disable Code ID Prefix**



@CIDENA1

Enable Code ID Prefix

Restore All Default Code IDs

For the information of default Code IDs, see the “Code ID Table” section in Appendix.



@CIDDEF

Restore All Default Code IDs

Modify Code ID

See the examples below to learn how to modify a Code ID and restore the default Code IDs of all symbologies.

E *sample*

Modify PDF417 Code ID to be “p” (HEX: 0x70):

1. Scan the **Modify PDF417 Code ID** barcode.
2. Scan the numeric barcodes “7” and “0” from the “Digit Barcodes” section in Appendix.
3. Scan the **Save** barcode from the “Save/Cancel Barcodes” section in Appendix.

Restore the default Code IDs of all symbologies:

1. Scan the **Restore All Default Code IDs** barcode.

ID symbologies:



@CID002

Modify Code 128 Code ID



@CID003

Modify GS1-128 Code ID



@CID004

Modify EAN-8 Code ID



@CID005

Modify EAN-13 Code ID



@CID006

Modify UPC-E Code ID



@CID007

Modify UPC-A Code ID



@CID008

Modify Interleaved 2 of 5 Code ID



@CID009

Modify ITF-14 Code ID



@CID010

Modify ITF-6 Code ID



@CID011

Modify Matrix 2 of 5 Code ID

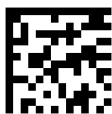

@CID013

Modify Code 39 Code ID



@CID015

Modify Codabar Code ID



@CID017

Modify Code 93 Code ID



@CID020

Modify AIM 128 Code ID



@CID021

Modify ISBT 128 Code ID



@CID022

Modify COOP 25 Code ID



@CID023

Modify ISSN Code ID



@CID024

Modify ISBN Code ID



@CID025

Modify Industrial 25 Code ID



@CID026

Modify Standard 25 Code ID



@CID027

Modify Plessey Code ID



@CID028

Modify Code 11 Code ID



@CID029

Modify MSI-Plessey Code ID



@CID031

Modify GS1 Databar Code ID



@CID030

Modify GS1 Composite Code ID

2D symbologies:



@CID032

Modify PDF417 Code ID



@CID033

Modify QR Code ID



@CID035

Modify Data Matrix Code ID

Custom Suffix

Enable/Disable Custom Suffix

If custom suffix is enabled, you are allowed to append to the data a user-defined suffix that cannot exceed 10 characters. For example, if the custom suffix is "AB" and the barcode data is "123", the Host will receive "123AB".



@CSUENAO

**** Disable Custom Suffix**



@CSUENA1

Enable Custom Suffix

Set Custom Suffix

To set a custom suffix, scan the **Set Custom Suffix** barcode then the numeric barcodes corresponding to the hexadecimal value of a desired suffix then the **Save** barcode.

Note: A custom suffix cannot exceed 10 characters.



@CSUSET

Set Custom Suffix

E
xample

Set the custom suffix to "CODE" (HEX: 0x43/0x4F/0x44/0x45):

1. Scan the **Set Custom Suffix** barcode.
2. Scan the numeric barcodes "4", "3", "4", "F", "4", "4", "4" and "5" from the "Digit Barcodes" section in Appendix.
3. Scan the **Save** barcode from the "Save/Cancel Barcodes" section in Appendix.
4. Scan the **Enable Custom Suffix** barcode.

Terminating Character Suffix

Enable/Disable Terminating Character Suffix

A terminating character such as carriage return (CR) or carriage return/line feed pair (CRLF) can only be used to mark the end of data, which means nothing can be added after it.



@TSUENAO

Disable Terminating Character Suffix



@TSUENAI

** Enable Terminating Character Suffix

Set Terminating Character Suffix

To set a terminating character suffix, scan the **Set Terminating Character Suffix** barcode then the numeric barcodes corresponding to the hexadecimal value of a desired terminating character then the **Save** barcode.

Note: A terminating character suffix cannot exceed 2 characters.



@TSUSET

Set Terminating Character Suffix



@TSUSET0D

**** Set Terminating Character to CR
(0x0D)**



@TSUSET0D0A

**Set Terminating Character to CRLF
(0x0D,0x0A)**

Set the terminating character suffix to 0x0A:

1. Scan the **Set Terminating Character Suffix** barcode.
2. Scan the numeric barcodes "0" and "A" from the "Digit Barcodes" section in Appendix.
3. Scan the **Save** barcode from the "Save/Cancel Barcodes" section in Appendix.
4. Scan the **Enable Terminating Character Suffix** barcode.

Chapter 9 Batch Programming

Introduction

Batch programming enables users to integrate a batch of commands into a single batch barcode.

Listed below are batch programming rules:

1. Command format: Command + Parameter Value.
2. Each command is terminated by a semicolon (;). Note that there is no space between a command and its terminator semicolon.
3. Use the barcode generator software to generate a 2D batch barcode.

Example: Create a batch barcode for **Illumination On, Sense Mode, Decode Session Timeout = 2s**:

1. Input the commands:

```
@ILLSCNI;SCNMOD2;ORTSET2000;
```

2. Generate a batch barcode.

When setting up a scanner with the above configuration, scan the **Enable Batch Barcode** barcode and then the batch barcode generated.



@BATCHS

Enable Batch Barcode

Create a Batch Command

A batch command may contain a number of individual commands each of which is terminated by a semicolon (;).

For more information, refer to the “Use of Programming Command” section in Chapter 3.

Create a Batch Barcode

Batch barcodes can be produced in the format of PDF417, QR Code or Data Matrix.

Example: Create a batch barcode for **Illumination On, Sense Mode, Decode Session Timeout = 2s**:

1. Input the following commands:

```
@ILLSCN1;SCNMOD2;ORTSET2000;
```

2. Generate a PDF417 batch barcode.



Use Batch Barcode

To put a batch barcode into use, scan the following barcodes. (Use the example above.)



@BATCHS

Enable Batch Barcode

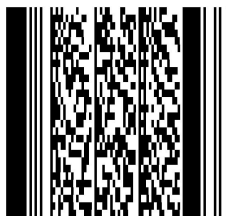

Batch Barcode

Appendix

Digit Barcodes

0~9



@DIGIT0

0



@DIGIT1

1



@DIGIT2

2



@DIGIT3

3



@DIGIT4

4



@DIGIT6

6



@DIGIT8

8



@DIGIT5

5



@DIGIT7

7



@DIGIT9

9

A~F



@DIGITA

A



@DIGITC

C



@DIGITE

E



@DIGITB

B



@DIGITD

D



@DIGITF

F

Save/Cancel Barcodes

After reading numeric barcode(s), you need to scan the **Save** barcode to save the data. If you scan the wrong digit(s), you can either scan the **Cancel** barcode and then start the configuration all over again, or scan the **Delete the Last Digit** barcode and then the correct digit, or scan the **Delete All Digits** barcode and then the digits you want.

For instance, after reading the **Maximum Length** barcode and numeric barcodes "1", "2" and "3", you scan:

- ✧ **Delete the Last Digit:** The last digit "3" will be removed.
- ✧ **Delete All Digits:** All digits "123" will be removed.
- ✧ **Cancel:** The maximum length configuration will be cancelled. And the scanner is still in the setup mode.



@DIGSAV

Save



@DIGCAN

Cancel



@DIGDEL

Delete the Last Digit



@DIGDAL

Delete All Digits

Factory Defaults Table

Parameter	Factory Default	Remark
System Settings		
Barcode Programming	Disabled (Exit Setup)	
Programming Barcode Data	Do not transmit	
Illumination	On	
Illumination Color	Red LED and White LED	
Interval Time of Illumination switching	2000ms	
Aiming	Normal	
Good Read LED	On	
Good Read LED Duration	Short (20ms)	
Power On Beep	On	
Good Read Beep	On	
Good Read Beep Duration	Medium (80ms)	
Good Read Beep Frequency	Medium (2730Hz)	
Good Read Beep Volume	High	
Number of Good Read Beeps	1	
Good Read Beep Interval Time	Short	
Good Read Vibration	Off	
Good Read Vibration Duration	300ms	
Default Scan Mode	Level Mode	
Decode Session Timeout	3,000ms	1-3,600,000ms; 0: infinite.
Timeout between Decodes	500ms	1-10,000ms
Reread Timeout	Enabled, 15,000ms	1-3,600,000ms
Good Read Delay	Disabled, 500ms	1-3,600,000ms
Image Decoding Timeout	500ms	1-3,000ms
Sensitivity	Level 1	Level 1-20
Scanning Preference	Normal Mode	
Read Barcode	On	
Decode Area	Priori on Aimed Barcode	
Specify Decoding Area	40% top, 60% bottom, 40% left, 60% right	
Image Flipping	Do Not Flip	
Image Resize	Original Image	
Default Interface	USB HID Keyboard	

RS-232 Interface		
Baud Rate	9600	
Parity Check	None	
Data Bits	8	
Stop Bits	1	
Hardware Auto Flow Control	Disabled	
USB Interface		
USB Country Keyboard	US keyboard	USB HID Keyboard
Beep on Unknown Character	Off	USB HID Keyboard
Emulate ALT+Keypad	Off	USB HID Keyboard
Code Page	Code Page 1252 (West European Latin)	USB HID Keyboard
Unicode Encoding	Off	USB HID Keyboard
Function Key Mapping	Disable	USB HID Keyboard
Inter-Keystroke Delay	No Delay	USB HID Keyboard
Convert Case	No Case Conversion	USB HID Keyboard
Emulate Numeric Keypad 1	Disabled	USB HID Keyboard
Emulate Numeric Keypad 2	Disabled	USB HID Keyboard
Polling Rate	4ms	USB HID Keyboard
Leading Zero	On	
Wireless Communication		
Batch Mode Option	Off	
Prevent Same Barcode Storage	Off	
Batch Mode Transmit Delay	No Transmit Delay (0ms)	
Auto Clear Flash Memory	Off	
Set End of Transmission Message	Off	
Wireless Scanner Sleep Timeout	15s	
Wireless Scanner Shutdown Timeout	30min	
Symbologies		
Global Settings		
Image Brightness Adaptation 1	15	
Image Brightness Adaptation 2	10	
ID Decoding Complexity	Medium	
ID Inverse	Regular and Inverse	
Code 128		
Code 128	Enabled	
Maximum Length	48	
Minimum Length	1	

EAN-8		
EAN-8	Enabled	
Check Character	Transmit	
2-Digit Add-On Code	Disabled	
5-Digit Add-On Code	Disabled	
Add-On Code	Not Required	
Add-On Code Separator	Off	
Convert EAN-8 to EAN-13	Disabled	
EAN-13		
EAN-13	Enabled	
Check Character	Transmit	
2-Digit Add-On Code	Disabled	
5-Digit Add-On Code	Disabled	
Add-On Code	Not required	
Add-On Code Separator	Off	
EAN-13 Beginning with 290 Add-On Code Required	Do Not Require Add-On Code	
EAN-13 Beginning with 378/379 Add-On Code Required	Do Not Require Add-On Code	
EAN-13 Beginning with 414/419 Add-On Code Required	Do Not Require Add-On Code	
EAN-13 Beginning with 434/439 Add-On Code Required	Do Not Require Add-On Code	
EAN-13 Beginning with 977 Add-On Code Required	Do Not Require Add-On Code	
EAN-13 Beginning with 978 Add-On Code Required	Do Not Require Add-On Code	
EAN-13 Beginning with 979 Add-On Code Required	Do Not Require Add-On Code	
UPC-E		
UPC-E0	Enabled	
UPC-E1	Disabled	
Check Character	Transmit	
2-Digit Add-On Code	Disabled	
5-Digit Add-On Code	Disabled	
Add-On Code	Not required	
Add-On Code Separator	Off	
Transmit Preamble Character	System Character	

Convert UPC-E to UPC-A	Disabled	
UPC-A		
UPC-A	Enabled	
Check Character	Transmit	
2-Digit Add-On Code	Disabled	
5-Digit Add-On Code	Disabled	
Add-On Code	Not required	
Add-On Code Separator	Off	
Transmit Preamble Character	System Character	
Interleaved 2 of 5		
Interleaved 2 of 5	Enabled	
Check Character Verification	Disabled	
Maximum Length	80	
Minimum Length	6	
ITF-14		
ITF-14	Disabled	
ITF-6		
ITF-6	Disabled	
Matrix 2 of 5		
Matrix 2 of 5	Enabled	
Check Character Verification	Disabled	
Maximum Length	80	
Minimum Length	4	
Code 39		
Code 39	Enabled	
Check Character Verification	Disabled	
Start/Stop Character	Do not transmit	
Code 39 Full ASCII	Disabled	
Maximum Length	48	
Minimum Length	1	
Codabar		
Codabar	Enabled	
Check Character Verification	Disabled	
Start/Stop Character	Do not transmit ABCD/ABCD as Start/Stop Character	
Maximum Length	60	
Minimum Length	2	
Code 93		

Code 93	Disabled	
Check Character	Do not transmit	
Check Character Verification	Enabled	
Maximum Length	48	
Minimum Length	1	
GSI-128 (UCC/EAN-128)		
GSI-128	Enabled	
Maximum Length	48	
Minimum Length	1	
AIM 128		
AIM 128	Disabled	
Maximum Length	48	
Minimum Length	1	
Check Character	Do not transmit	
ISBT 128		
ISBT 128	Disabled	
Code 11		
Code 11	Disabled	
Check Character	Transmit	
Check Character Verification	One Check Character, MOD11	
Maximum Length	48	
Minimum Length	4	
ISBN		
ISBN	Disabled	
ISBN Format	ISBN-10	
ISSN		
ISSN	Disabled	
Industrial 25		
Industrial 25	Disabled	
Check Character Verification	Disabled	
Maximum Length	48	
Minimum Length	6	
Standard 25		
Standard 25	Disabled	
Check Character Verification	Disabled	
Maximum Length	48	
Minimum Length	6	
COOP 25		

COOP 25	Disabled	
Check Character Verification	Disabled	
Maximum Length	48	
Minimum Length	1	
Deutsche 14		
Deutsche 14	Disabled	
Deutsche 12		
Deutsche 12	Disabled	
Plessey		
Plessey	Disabled	
Check Character Verification	Disabled	
Maximum Length	48	
Minimum Length	4	
MSI-Plessey		
MSI-Plessey	Disabled	
Check Character	Transmit	
Check Character Verification	One Check Character, MOD10	
Maximum Length	48	
Minimum Length	4	
PDF417		
PDF417	Enabled	
PDF417 Inverse	Decode Both	
Character Encoding	Default Character Encoding	
Maximum Length	2710	
Minimum Length	1	
QR Code		
QR Code	Enabled	
Read Single QR Only	Enabled	
QR Inverse	Read regular & inverse barcodes	
Character Encoding	Default Character Encoding	
QR ECI Output	Enabled	
Maximum Length	7089	
Minimum Length	1	
QR Decoding Complexity	Medium	
Continuous Code	Enabled	
Dot-peen Code	Enabled	
Mirror Code	Enabled	
QR Model 1	Enabled	

QR Model 2	Enabled	
Data Matrix		
Data Matrix	Enabled	
Rectangular Barcode	Enabled	
Data Matrix Inverse	Read regular & inverse barcodes	
Character Encoding	Default Character Encoding	
Data Matrix ECI Output	Enabled	
Maximum Length	3116	
Minimum Length	1	
Data Matrix Decoding Complexity	Medium	
ECC200	Enabled	
ECCTO140	Enabled	
Continuous Mode	Enabled	
Dot-peen Code	Enabled	
Mirror Code	Enabled	
Data Formatter		
Data Formatter	Disabled	
Non-Match Error Beep	On	
Data Format Selection	Format_0	
Prefix & Suffix		
Prefix Sequence	Code ID+ Custom +AIM ID	
Custom Prefix	Disabled	
AIM ID Prefix	Disabled	
Code ID Prefix	Disabled	
Custom Suffix	Disabled	
Terminating Character Suffix	Enabled	

AIM ID Table

Symbology	AIM ID	Possible AIM ID Modifiers (m)
Code 128]C0	
GSI-128 (UCC/EAN-128)]C1	
EAN-8]E4	
EAN-8 with Addon]E3	
EAN-13]E0	
EAN-13 with Addon]E3	
UPC-E]E0	
UPC-E with Addon]E3	
UPC-A]E0	
UPC-A with Addon]E3	
Interleaved 2 of 5]Im	0, 1, 3
ITF-14]Im	1, 3
ITF-6]Im	1, 3
Matrix 2 of 5]X0	
Code 39]Am	0, 1, 3, 4, 5, 7
Codabar]Fm	0, 2, 4
Code 93]G0	
ISSN]X0	
ISBN]X0	
Industrial 25]S0	
Standard 25]R0	
COOP 25]X0	
Deutsche 12]X0	
Deutsche 14]X0	
AIM 128]C2	
Plessey]P0	
Code 11]Hm	0, 1, 3
MSI Plessey]Mm	0, 1
PDF417]Lm	0-2
QR Code]Qm	0-6
Data Matrix]dm	0-6

Note: “m” represents the AIM modifier character. Refer to ISO/IEC 15424:2008 Information technology – Automatic identification and data capture techniques – Data Carrier Identifiers (including Symbology Identifiers) for AIM modifier character details.

Code ID Table

Symbology	Code ID
Code128	j
GSI-128 (UCC/EAN-128)	j
EAN-8	d
EAN-13	d
UPC-E	c
UPC-A	c
Interleaved 2 of 5	e
ITF-14	e
ITF-6	e
Matrix 2 of 5	v
Code 39	b
Codabar	a
Code 93	i
AIM 128	X
COOP 25	X
Deutsche 12	X
Deutsche 14	X
ISSN	g
ISBN	B
Industrial 2/5	l
Standard 2/5	f
Plessey	n
Code 11	H
MSI Plessey	m
PDF417	r
QR Code	s
Data Matrix	u

Symbology ID Number

Symbology	ID Number
Code 128	002
GSI-128 (UCC/EAN-128)	003
EAN-8	004
EAN-13	005
UPC-E	006
UPC-A	007
Interleaved 2 OF 5	008
ITF-14	009
ITF-6	010
Matrix 2 of 5	011
Code 39	013
Codabar	015
Code 93	017
AIM 128	020
COOP 25	022
ISSN	023
ISBN	024
Industrial25	025
Standard25	026
Plessey	027
Code11	028
MSI-Plessey	029
PDF417	032
QR Code	033
Data Matrix	035
Deutsche 14	128
Deutsche 12	129

ASCII Table

Hex	Dec	Char
00	0	NUL (Null char.)
01	1	SOH (Start of Header)
02	2	STX (Start of Text)
03	3	ETX (End of Text)
04	4	EOT (End of Transmission)
05	5	ENQ (Enquiry)
06	6	ACK (Acknowledgment)
07	7	BEL (Bell)
08	8	BS (Backspace)
09	9	HT (Horizontal Tab)
0a	10	LF (Line Feed)
0b	11	VT (Vertical Tab)
0c	12	FF (Form Feed)
0d	13	CR (Carriage Return)
0e	14	SO (Shift Out)
0f	15	SI (Shift In)
10	16	DLE (Data Link Escape)
11	17	DC1 (XON) (Device Control 1)
12	18	DC2 (Device Control 2)
13	19	DC3 (XOFF) (Device Control 3)
14	20	DC4 (Device Control 4)
15	21	NAK (Negative Acknowledgment)
16	22	SYN (Synchronous Idle)
17	23	ETB (End of Trans. Block)
18	24	CAN (Cancel)
19	25	EM (End of Medium)
1a	26	SUB (Substitute)
1b	27	ESC (Escape)
1c	28	FS (File Separator)
1d	29	GS (Group Separator)

Hex	Dec	Char
1e	30	RS (Request to Send)
1f	31	US (Unit Separator)
20	32	SP (Space)
21	33	! (Exclamation Mark)
22	34	" (Double Quote)
23	35	# (Number Sign)
24	36	\$ (Dollar Sign)
25	37	% (Percent)
26	38	& (Ampersand)
27	39	` (Single Quote)
28	40	((Left/ Opening Parenthesis)
29	41) (Right/ Closing Parenthesis)
2a	42	* (Asterisk)
2b	43	+ (Plus)
2c	44	, (Comma)
2d	45	- (Minus/ Dash)
2e	46	. (Dot)
2f	47	/ (Forward Slash)
30	48	0
31	49	1
32	50	2
33	51	3
34	52	4
35	53	5
36	54	6
37	55	7
38	56	8
39	57	9
3a	58	: (Colon)
3b	59	; (Semi-colon)
3c	60	< (Less Than)
3d	61	= (Equal Sign)

Hex	Dec	Char
3e	62	> (Greater Than)
3f	63	? (Question Mark)
40	64	@ (AT Symbol)
41	65	A
42	66	B
43	67	C
44	68	D
45	69	E
46	70	F
47	71	G
48	72	H
49	73	I
4a	74	J
4b	75	K
4c	76	L
4d	77	M
4e	78	N
4f	79	O
50	80	P
51	81	Q
52	82	R
53	83	S
54	84	T
55	85	U
56	86	V
57	87	W
58	88	X
59	89	Y
5a	90	Z
5b	91	[(Left/ Opening Bracket)
5c	92	\ (Back Slash)
5d	93] (Right/ Closing Bracket)

Hex	Dec	Char
5e	94	^ (Caret/ Circumflex)
5f	95	_ (Underscore)
60	96	' (Grave Accent)
61	97	a
62	98	b
63	99	c
64	100	d
65	101	e
66	102	f
67	103	g
68	104	h
69	105	i
6a	106	j
6b	107	k
6c	108	l
6d	109	m
6e	110	n
6f	111	o
70	112	p
71	113	q
72	114	r
73	115	s
74	116	t
75	117	u
76	118	v
77	119	w
78	120	x
79	121	y
7a	122	z
7b	123	{ (Left/ Opening Brace)
7c	124	(Vertical Bar)
7d	125	} (Right/ Closing Brace)
7e	126	~ (Tilde)
7f	127	DEL (Delete)

Newland AIDC

 No.1 Rujiang West Rd., Mawei, Fuzhou, Fujian 350015, China

 +86-591-83979500

 info@nlscan.com

 www.newlandaidc.com

Asia Pacific

Japan:

住所: 〒108-0075

東京都港区港南 1 丁目 9-3 6

アレア品川ビル 13 階 407

電話: 03-4405-3222

メール: info@nlscan.com

India:

Add: 416 & 417, Tower C, NOIDA ONE business park, B-8, Sector 62, Noida,

Uttar Pradesh - 201301

Tel: +91 120 3508102

Email: info@nlscan.com

Indonesia:

Add: Eightyeight@kasablanca Tower A 12th Floor Unit A&H, Jl. Casablanca Raya Kav. 88, Jakarta Selatan 12870

Tel: +62 8161157247

Email: info@nlscan.com

Korea:

Add: Biz. Center Best-one, Jang-eun Medical

Plaza 6F, Bojeong-dong 1261-4, Kihung-gu,

Yongin-City, Kyunggi-do, South Korea

Tel: +82 10 8990 4838

Email: info@nlscan.com

Taiwan:

Add: 7F-6, No. 268, Liancheng Rd.,

Jhonghe Dist. 235, New Taipei City,

Taiwan

Tel: +886 2 7731 5388

Email: info@nlscan.com

Europe & Middle East & Africa

Add: Rolweg 25, 4104 AV Culemborg, The Netherlands

Tel: +31 (0) 345 87 00 33

Web: www.newland-id.com

Email: sales@newland-id.com

Tech Support: tech-support@newland-id.com

North America

Add: 46559 Fremont Blvd., Fremont, CA 94538, USA

Tel: +1 510 490 3888

Email: info@nlscan.com

Latin America

Tel: +1 239 598 0068

Email: Info@NewlandLA.com

Brazil:

Tel: +55 35 9767 6078

Email: Info@NewlandLA.com

Chile:

Tel: +56 9 9337 3177

Email: Chile@NewlandLA.com

Colombia:

Tel: +57 319 387 4484

Email: Colombia@NewlandLA.com

Mexico, Central America & Caribbean:

Tel: +52 155 5432 9079

Email: Mexico@NewlandLA.com



Newland AIDC
Scanning Made Simple

