

2D Handheld Barcode Scanner

User Guide

Disclaimer

Please read through the manual carefully before using the product and operate it according to the manual. It is advised that you should keep this manual for future reference.

Do not disassemble the device or remove the seal label from the device, doing so will void the product warranty provided by Shanghai Sunmi Tech. Co., Ltd.

All pictures in this manual are for reference only and actual product may differ. Regarding to the product modification and update, Shanghai Sunmi Tech. Co., Ltd. reserves the right to make changes to any software or hardware to improve reliability, function, or design at any time without notice. The information contained herein is subject to change without prior notice.

The products depicted in this manual may include software copyrighted by Shanghai Sunmi Tech. Co., Ltd or third party. The user, corporation or individual, shall not duplicate, in whole or in part, distribute, modify, decompile, disassemble, decode, reverse engineer, rent, transfer or sublicense such software without prior written consent from the copyright holders.

This manual is copyrighted. No part of this publication may be reproduced, distributed or used in any form without written permission from Sunmi.

Shanghai Sunmi Tech. Co., Ltd. reserves the right to make final interpretation of the statement above.

Revision History

Version	Description	Date
V1.0.0	Initial release.	February 25, 2019

Table of Contents

Revision History	3
Preface	12
Introduction	12
Chapter Description	12
Explanation of Icons	14
Chapter 1 Getting Started	15
Introduction	15
Unpacking	15
the Scanner	16
Data Port Pinout	17
Connecting the the to a Host.....	18
Using USB Cable	18
Power On, Sleep, Power Off, Reboot	19
Maintenance	19
Dimensions (unit: mm)	20
Left View.....	20
Front View	21
Top View.....	21
Scanning Instructions	22
Chapter 2 System Settings	23
Introduction	23
Barcode Programming.....	23
Command Programming.....	23
Programming Barcode/ Programming Command/Function	23
Use of Programming Command.....	24
Command Syntax	24
Query Commands.....	24
Responses.....	25
Examples	25
Use of Programming Barcodes	26
Illumination.....	27
Aiming	27
Good Read LED	28
Good Read LED Duration.....	29

Power On Beep	30
Good Read Beep.....	30
Good Read Beep Volume	31
Good Read Vibration	31
Good Read Vibration Duration	32
Scan Mode.....	33
Decode Session Timeout	34
Image Stabilization Timeout (Sense Mode).....	35
Timeout between Decodes (Same Barcode)	36
Reread Timeout Reset	37
Image Decoding Timeout	37
Sensitivity	38
Trigger Commands	39
Modify Start Scanning Command.....	39
Modify Stop Scanning Command	40
Scanning Preference	41
Read Barcode On/Off.....	41
Decode Area.....	42
Image Flipping.....	44
Bad Read Message	45
Set Bad Read Message	45
Default Settings	46
Factory Defaults	46
Custom Defaults.....	46
Query Product Information.....	48
Query Product Name	48
Query Firmware Version	48
Query Decoder Version	49
Query Hardware Version.....	49
Query Product Serial Number	49
Query Manufacturing Date	50
Query OEM Serial Number	50
Query Data Formatter Version	50
Chapter 3 USB Interface.....	51
Introduction	51
USB HID Keyboard.....	52
USB Country Keyboard Types.....	53

Beep on Unknown Character	57
Emulate ALT+Keypad	58
Code Page	59
Unicode Encoding	61
Emulate Keypad with Leading Zero	61
Function Key Mapping	62
ASCII Function Key Mapping Table	63
ASCII Function Key Mapping Table (Continued)	64
Inter-Keystroke Delay	65
Caps Lock	66
Convert Case	66
Emulate Numeric Keypad	68
Fast Mode	70
Polling Rate	71
USB CDC	73
HID POS (POS HID Barcode Scanner)	74
Introduction	74
Access the Scanner with Your Program	74
Acquire Scanned Data	75
Send Command to the Scanner	75
VID/PID	76
Chapter 4 Symbologies	77
Introduction	77
Global Settings	77
Enable/Disable All Symbologies	77
Enable/Disable 1D Symbologies	77
Enable/Disable 2D Symbologies	78
1D Twin Code	78
Code 128	80
Restore Factory Defaults	80
Enable/Disable Code 128	80
Set Length Range for Code 128	81
EAN-8	82
Restore Factory Defaults	82
Enable/Disable EAN-8	82
Transmit Check Character	82
2-Digit Add-On Code	83

5-Digit Add-On Code	84
Convert EAN-8 to EAN-13	85
EAN-13	86
Restore Factory Defaults	86
Enable/Disable EAN-13	86
Transmit Check Character	87
2-Digit Add-On Code	87
5-Digit Add-On Code	88
UPC-E	88
Restore Factory Defaults	88
Enable/Disable UPC-E	89
Transmit Check Character	90
2-Digit Add-On Code	90
5-Digit Add-On Code	91
Transmit Preamble Character	92
Convert UPC-E to UPC-A	92
UPC-A	93
Restore Factory Defaults	93
Enable/Disable UPC-A	93
Transmit Check Character	93
2-Digit Add-On Code	94
5-Digit Add-On Code	95
Transmit Preamble Character	96
Coupon	97
UPC-A/EAN-13 with Extended Coupon Code	97
Coupon GS1 Databar Output	98
Interleaved 2 of 5	99
Restore Factory Defaults	99
Enable/Disable Interleaved 2 of 5	99
Set Length Range for Interleaved 2 of 5	100
Check Character Verification	101
ITF-14	102
Restore Factory Defaults	102
Enable/Disable ITF-14	102
ITF-6	104
Restore Factory Defaults	104
Enable/Disable ITF-6	104
Matrix 2 of 5	105

Restore Factory Defaults	105
Enable/Disable Matrix 2 of 5	105
Set Length Range for Matrix 2 of 5	106
Check Character Verification	107
Code 39	108
Restore Factory Defaults	108
Enable/Disable Code 39	108
Set Length Range for Code 39.....	109
Check Character Verification	110
Transmit Start/Stop Character	111
Enable/Disable Code 39 Full ASCII	111
Enable/Disable Code 32 (Italian Pharma Code)	112
Code 32 Prefix.....	112
Transmit Code 32 Start/Stop Character.....	113
Transmit Code 32 Check Character.....	113
Codabar	114
Restore Factory Defaults	114
Enable/Disable Codabar	114
Set Length Range for Codabar	115
Check Character Verification	116
Start/Stop Character	117
Code 93	118
Restore Factory Defaults	118
Enable/Disable Code 93	118
Set Length Range for Code 93.....	119
Check Character Verification	120
China Post 25.....	121
Restore Factory Defaults	121
Enable/Disable China Post 25.....	121
Set Length Range for China Post 25	122
Check Character Verification	123
GS1-128 (UCC/EAN-128).....	124
Restore Factory Defaults	124
Enable/Disable GS1-128	124
Set Length Range for GS1-128.....	125
GS1 Databar (RSS)	126
Restore Factory Defaults	126
Enable/Disable GS1 Databar.....	126

Transmit Application Identifier "01"	126
GS1 Composite (EAN·UCC Composite).....	127
Restore Factory Defaults	127
Enable/Disable GS1 Composite	127
Enable/Disable UPC/EAN Composite	127
Code 11.....	128
Restore Factory Defaults	128
Enable/Disable Code 11.....	128
Set Length Range for Code 11	130
Check Character Verification	131
Transmit Check Character	132
ISBN	133
Restore Factory Defaults	133
Enable/Disable ISBN	133
Set ISBN Format.....	134
ISSN	135
Restore Factory Defaults	135
Enable/Disable ISSN	135
Industrial 25	136
Restore Factory Defaults	136
Enable/Disable Industrial 25	136
Set Length Range for Industrial 25	137
Check Character Verification	138
Standard 25	139
Restore Factory Defaults	139
Enable/Disable Standard 25	139
Set Length Range for Standard 25	140
Check Character Verification	141
Plessey	142
Restore Factory Defaults	142
Enable/Disable Plessey	142
Set Length Range for Plessey.....	143
Check Character Verification	144
MSI-Plessey.....	145
Restore Factory Defaults	145
Enable/Disable MSI-Plessey.....	145
Set Length Range for MSI-Plessey.....	146
Check Character Verification	147

Transmit Check Character	148
AIM 128	149
Restore Factory Defaults	149
Enable/Disable AIM 128	149
Set Length Range for AIM 128	150
ISBT 128	151
Restore Factory Defaults	151
Enable/Disable ISBT 128	151
PDF417	152
Restore Factory Defaults	152
Enable/Disable PDF417	152
Set Length Range for PDF417	153
PDF417 Twin Code	154
PDF417 Inverse	155
Character Encoding	155
PDF417 ECI Output	156
QR Code	157
Restore Factory Defaults	157
Enable/Disable QR Code	157
Set Length Range for QR Code	158
QR Twin Code	159
QR Inverse	160
Character Encoding	160
QR ECI Output	161
Aztec	162
Restore Factory Defaults	162
Enable/Disable Aztec Code	162
Set Length Range for Aztec Code	163
Read Multi-barcodes on an Image	164
Set the Number of Barcodes	165
Character Encoding	166
Aztec ECI Output	166
Data Matrix	167
Restore Factory Defaults	167
Enable/Disable Data Matrix	167
Set Length Range for Data Matrix	168
Data Matrix Twin Code	169
Rectangular Barcode	170

Data Matrix Inverse	170
Character Encoding.....	171
Data Matrix ECI Output	171
Chapter 5 Data Formatter	172
Introduction	172
Add a Data Format.....	172
Programming with Barcodes.....	172
Programming with Serial Commands	175
Enable/Disable Data Formatter	176
Non-Match Error Beep	177
Data Format Selection	178
Change Data Format for a Single Scan	179
Clear Data Format	180
Query Data Formats.....	180
Formatter Command Type 6	181
Send Commands	181
Move Commands.....	185
Search Commands.....	187
Miscellaneous Commands	190
Chapter 6 Prefix & Suffix.....	196
Introduction	196
Global Settings.....	197
Enable/Disable All Prefixes/Suffixes	197
Prefix Sequence	197
Custom Prefix.....	198
Enable/Disable Custom Prefix.....	198
Set Custom Prefix.....	198
AIM ID Prefix	199
Code ID Prefix.....	200
Restore All Default Code IDs	200
Modify Code ID.....	200
Custom Suffix.....	206
Enable/Disable Custom Suffix.....	206
Set Custom Suffix.....	206
Data Packing	207
Introduction.....	207
Data Packing Options	207

Terminating Character Suffix.....	209
Enable/Disable Terminating Character Suffix.....	209
Set Terminating Character Suffix.....	209
Chapter 7 Batch Programming	211
Introduction	211
Create a Batch Command.....	212
Create a Batch Barcode	212
Use Batch Barcode.....	213
Appendix.....	214
Digit Barcodes.....	214
Save/Cancel Barcodes	217
Factory Defaults Table	218
AIM ID Table	224
Code ID Table.....	226
Symbology ID Number.....	227
ASCII Table.....	228
Unicode Key Maps.....	232

Preface

Introduction

This manual provides detailed instructions for setting up and using the 2D handheld barcode scanner (hereinafter referred to as “**the scanner**”).

Chapter Description

<i>Chapter 1 Getting Started</i>	: Gives a general description of the scanner.
<i>Chapter 2 System Settings</i>	: Introduces three configuration methods and describes how to configure general parameters of the scanner.
<i>Chapter 3 USB Interface</i>	: Describes how to configure USB communication parameters.



@SETUPE1

Enter Setup

- Chapter 4 Symbologies* : Lists all compatible symbologies and describes how to configure the relevant parameters.
- Chapter 5 Data Formatter* : Explains how to customize scanned data with the data formatter.
- Chapter 6 Prefix & Suffix* : Describes how to use prefix and suffix to customize scanned data.
- Chapter 7 Batch Programming* : Explains how to integrate a complex programming task into a single barcode.
- Appendix* : Provides factory defaults table and a bunch of frequently used programming barcodes.



@SETUPE0

**** Exit Setup**



@SETUPE1
Enter Setup

Explanation of Icons



This icon indicates something relevant to this manual.



This icon indicates this information requires extra attention from the reader.



This icon indicates handy tips that can help you use or configure the scanner with ease.



This icon indicates practical examples that can help you to acquaint yourself with operations.



@SETUPE0
** Exit Setup



@SETUPE1
Enter Setup

Chapter 1 Getting Started

Introduction

The scanner reads a 1D or 2D barcode by capturing its image. Quick image capture and accurate decoding performance meet customers' needs.

An illustrated introduction to the scanner is included in this chapter. If you have a scanner at hand, make good use of it to develop a better understanding of this manual. This chapter is written for normal users, maintenance staff and software developers.

Unpacking

Open the package and take out the scanner and its accessories. Check to make sure everything on the packing list is present and intact. If any contents are damaged or missing, please keep the original package and contact your dealer immediately for after-sales service.



@SETUPE0
**** Exit Setup**



@SETUPE1
Enter Setup

the Scanner

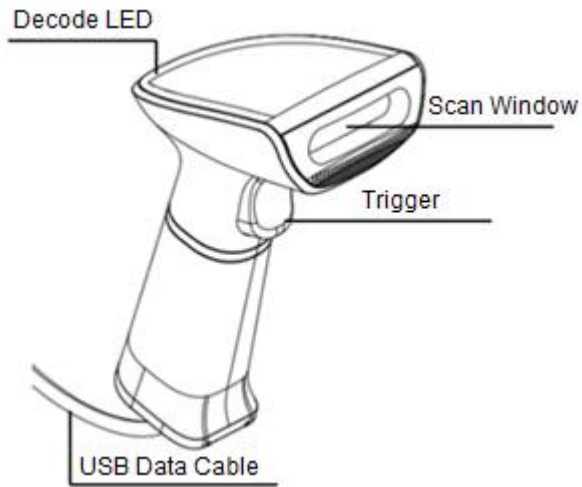

Fig. 1-1

Decode LED Definitions

When the LED is in the normal mode, it means the scanner is powered on; when the LED flashes, it means the barcode is decoded successfully.

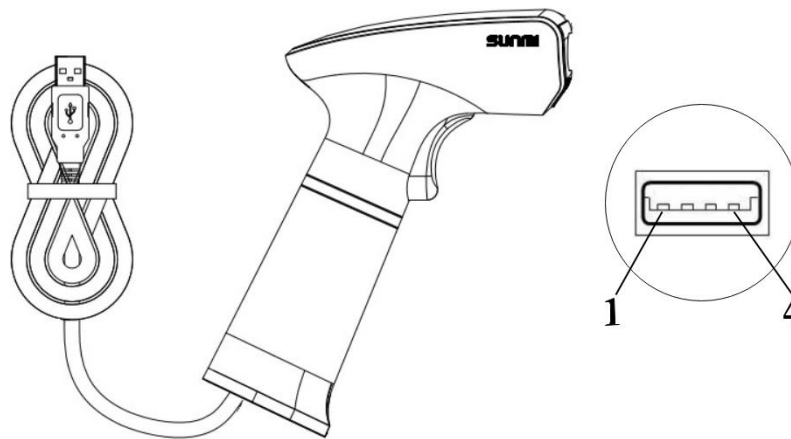

Fig. 1-2



@SETUPE0
** Exit Setup



@SETUPE1
Enter Setup

Data Port Pinout

PIN	Signal	Type	Function
1	GND	P	USB ground
2	D+	I/O	USB D+ signal
3	D-	I/O	USB D- signal
4	VCC	P	USB VCC +5V



@SETUPE0
** Exit Setup



@SETUPE1
Enter Setup

Connecting the the to a Host

The scanner must be connected to a Host in actual application, such as PC, POS or any intelligent terminal with USB port, using a communication cable

USB



Fig. 1-3

Using USB Cable

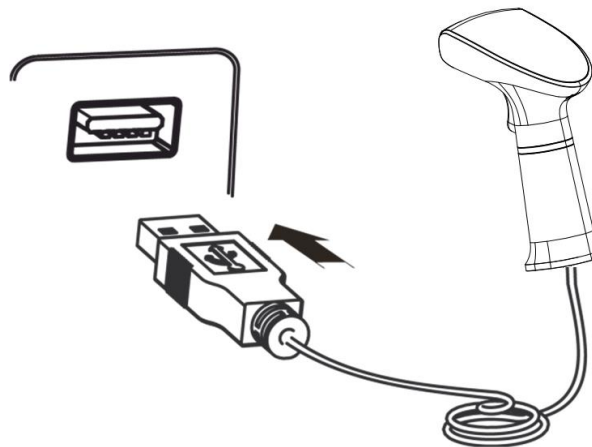

Fig. 1-4

Connect the scanner to a Host through a USB cable:

1. Plug the USB connector into the USB port on the Host.
2. Power on the scanner.



@SETUPE0
** Exit Setup



@SETUPE1
Enter Setup

Power On, Sleep, Power Off, Reboot

Power on the scanner

Connect the scanner to a Host. Then the scanner will be turned on and automatically enter the sleep mode.

Enter the sleep mode

If no operation is performed on the device for some time, the device will automatically enter the sleep state.

Power off the scanner

Remove the cable from the Host.

Reboot the scanner

If the scanner stops responding to input or runs abnormally, turn off the scanner and then turn it back on.

Maintenance

- ◇ The scan window should be kept clean.
- ◇ Do not scratch the scan window.
- ◇ Use soft brush to remove the stain from the scan window.
- ◇ Use the soft cloth to clean the window, such as eyeglass cleaning cloth.
- ◇ Do not spray any liquid on the scan window.
- ◇ Do not use any detergent to clean other parts of the device except for water.



The warranty **DOES NOT** cover damages caused by inappropriate care and maintenance.



@SETUPE0
** Exit Setup



@SETUPE1
Enter Setup

Dimensions (unit: mm)

Left View

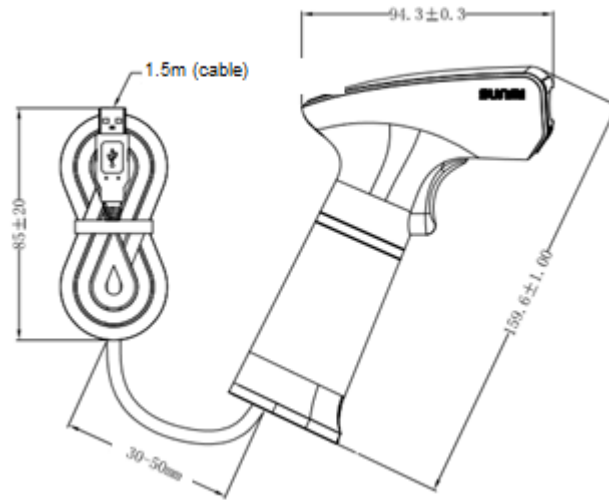

Fig. 1-5



@SETUPE0
** Exit Setup



@SETUPE1
Enter Setup

Front View

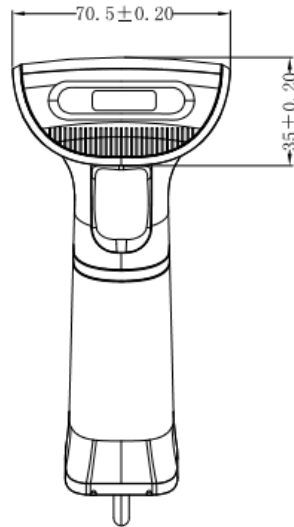

Fig. 1-6

Top View

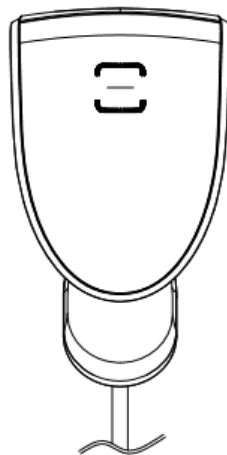

Fig. 1-7



@SETUPE0
** Exit Setup



@SETUPE1
Enter Setup

Scanning Instructions

When the scanner is in the Manual scan mode, you can follow the steps below to scan a barcode:

1. Press and hold the trigger (see Fig.1-11). Then the scanner will project a red aiming beam.
2. Aim the red beam across the center of barcode.
3. Release the trigger when the red beam goes off. If the barcode is decoded successfully, the scanner will emit a good read beep and the decoded data will be sent to the Host.

Note: For barcodes of the same batch, the scanner keeps a very high success ratio in certain distance which is regarded as the optimal scanning distance.

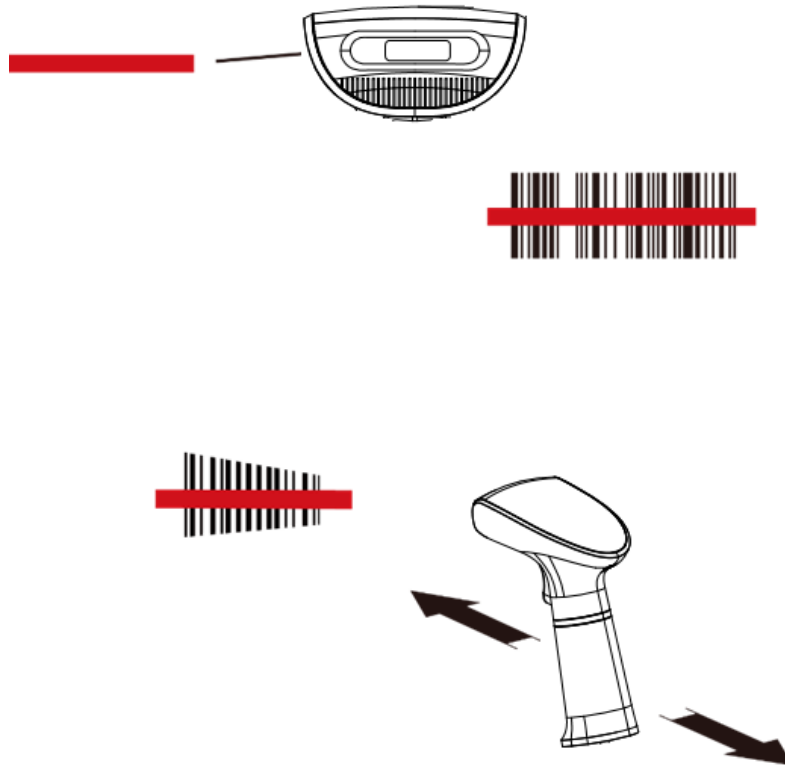

Fig. 1-8



@SETUPE0
** Exit Setup



Chapter 2 System Settings

Introduction

There are two ways to configure the scanner: barcode programming and command programming.

Barcode Programming

The scanner can be configured by scanning programming barcodes. All user programmable features/options are described along with their programming barcodes/commands in the following sections.

This programming method is most straightforward. However, it requires manually scanning barcodes. As a result, errors are more likely to occur.

Command Programming

The scanner can also be configured by serial commands sent from the host device.

Users can design an application program to send those command strings to the scanners to perform device configuration.

Programming Barcode/ Programming Command/Function



The figure above is an example that shows you the programming barcode and command for the Enter Setup function:

1. The **No Case Conversion** barcode.
2. The **No Case Conversion** command.
3. The description of feature/option.
4. ** indicates factory default settings.





@SETUPE1
Enter Setup

Use of Programming Command

Besides the barcode programming method, the scanner can also be configured by serial commands (HEX) sent from the host device. **All commands must be entered in uppercase letters.**

Command Syntax

Prefix StorageType Tag SubTag {Data} [,SubTag {Data}] [:Tag SubTag {Data}] [...] Suffix

Prefix: "~<SOH>0000" (HEX: **7E 01 30 30 30 30**), 6 characters.

StorageType: "@" (HEX: **40**) or "#" (HEX: **23**), 1 character. "@" means permanent setting which will not be lost by removing power from the scanner or rebooting it; "#" means temporary setting which will be lost by removing power from the scanner or rebooting it.

Tag: A 3-character case-sensitive field that identifies the desired command group. For example, all USB HID Keyboard configuration settings are identified with a Tag of KBW.

SubTag: A 3-character case-sensitive field that identifies the desired parameter within the tag group. For example, the SubTag for the keyboard layout is CTY.

Data: The value for a feature or parameter setting, identified by the Tag and SubTag.

Suffix: ";<ETX>" (HEX: **3B 03**), 2 characters.

Multiple commands can be issued within one Prefix/Suffix sequence. For configuration commands, only the **Tag**, **SubTag**, and **Data** fields must be repeated for each command in sequence. If an additional command is to be applied to the same Tag, then the command is separated with a comma (,) and only the **SubTag** and **Data** fields of the additional commands are issued. If the additional command requires a different **Tag** field, the command is separated from previous command by a semicolon (;).

Query Commands

For query commands, the entry in the **Data** field in the syntax above is one of the following characters means:

- * (HEX: **2A**) What is the scanner's current value for the setting(s).
- & (HEX: **26**) What is the factory default value for the setting(s).
- ^ (HEX: **5E**) What is the range of possible values for the setting(s).



@SETUPE0
** Exit Setup



@SETUPE1
Enter Setup

The value of the **StoreType** field in a query command can be either "@" (HEX: 40) or "#" (HEX: 23).

A query command with the **SubTag** field omitted means to query all the settings concerning a tag. For example, to query all the current settings about Code 11, you should enter **7E 01 30 30 30 30 40 43 31 31 2A 3B 03** (i.e. ~<SOH>0000@C11*; <ETX>).

Responses

Different from command sequence, the prefix of a response consists of the six characters of "<STX><SOH>0000" (HEX: **02 01 30 30 30 30**).

The scanner responds to serial commands with one of the following three responses:

- <ACK> (HEX: 06) Indicates a good command which has been processed.
- <NAK> (HEX: 15) Indicates a good configuration command with its **Data** field entry out of the allowable range for this Tag and SubTag combination (e.g. an entry for an inter-keystroke delay of 100 when the field will only allow 2 digits), or an invalid query command.
- <ENQ> (HEX: 05) Indicates an invalid Tag or SubTag command.

When responding, the scanner echoes back the command sequence with the status character above inserted directly before each of the punctuation marks (the comma or semicolon) in the command.

Examples

Example 1: Enable Code 11, set the minimum and maximum lengths to 12 and 22 respectively.

Enter: **7E 01 30 30 30 30 40 43 31 31 45 4E 41 31 2C 4D 49 4E 31 32 2C 4D 41 58 32 32 3B 03**
(~<SOH>0000@C11ENA1,MIN12,MAX22;<ETX>)

Response: **02 01 30 30 30 30 40 43 31 31 45 4E 41 31 06 2C 4D 49 4E 31 32 06 2C 4D 41 58 32 32 06 3B 03**
(<STX><SOH>0000@C11ENA1<ACK>,MIN12<ACK>,MAX22<ACK>;<ETX>)

Example 2: Query the current minimum and maximum lengths of Code 11.

Enter: **7E 01 30 30 30 30 40 43 31 31 4D 49 4E 2A 2C 4D 41 58 2A 3B 03**
(~<SOH>0000@C11MIN*,MAX*;<ETX>)

Response: **02 01 30 30 30 30 40 43 31 31 4D 49 4E 31 32 06 2C 4D 41 58 32 32 06 3B 03**
(<STX><SOH>0000@C11MIN12<ACK>,MAX22<ACK>;<ETX>)

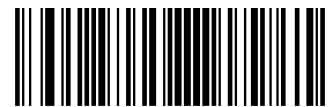

@SETUPE0
** Exit Setup



@SETUPE1
Enter Setup

Use of Programming Barcodes

Scanning the **Enter Setup** barcode can enable the scanner to enter the setup mode. Then you can scan a number of programming barcodes to configure your scanner. To exit the setup mode, scan the **Exit Setup** barcode or a non-programming barcode, or reboot the scanner.



@SETUPE0
**** Exit Setup**



@SETUPE1
Enter Setup

Programming barcode data (i.e. the characters under programming barcode) can be transmitted to the host device. Scan the appropriate barcode below to enable or disable the transmission of programming barcode data to the host device.



@SETUPT0
**** Do Not Transmit Programming Barcode Data**

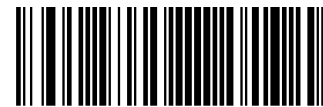

@SETUPT1
Transmit Programming Barcode Data



@SETUPE0
**** Exit Setup**



@SETUPE1
Enter Setup

Illumination



@ILLSCN1
**** On**



@ILLSCN0
Off



@ILLSCN2
Always On

Aiming



@AMLENA1
**** On**



@AMLENA0
Off



@AMLENA2
Always On



@SETUPE0
**** Exit Setup**



@SETUPE1
Enter Setup

Good Read LED

The green LED can be programmed to be On or Off to indicate good read.



@GRLENA1
**** On**



@GRLENA0
Off



@SETUPE0
**** Exit Setup**



@SETUPE1
Enter Setup

Good Read LED Duration

This parameter sets the amount of time that the Good Read LED to remain on following a good read. It is programmable in 1ms increments from 1ms to 2,500ms.



@GRLDUR20
**** Short (20ms)**



@GRLDUR120
Medium (120ms)



@GRLDUR220
Long (220ms)



@GRLDUR320
Prolonged (320ms)



@GRLDUR
Custom (1 - 2,500ms)

E
example

Set the Good Read LED duration to 800ms:

1. Scan the **Enter Setup** barcode.
2. Scan the **Custom** barcode.
3. Scan the numeric barcodes "8", "0" and "0" from the "Digit Barcodes" section in Appendix.
4. Scan the **Save** barcode from the "Save/Cancel Barcodes" section in Appendix.
5. Scan the **Exit Setup** barcode.

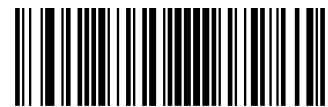

@SETUPE0
**** Exit Setup**



@SETUPE1
Enter Setup

Power On Beep

The scanner can be programmed to beep when it is powered on. Scan the **Off** barcode if you do not want a power on beep.



@PWBENA1
**** On**



@PWBENA0
Off

Good Read Beep

Scanning the **Off** barcode can turn off the beep that indicates successful decode; scanning the **On** barcode can turn it back on.



@GRBENA1
**** On**



@GRBENA0
Off



@SETUPE0
**** Exit Setup**



@SETUPE1
Enter Setup

Good Read Beep Volume



@GRBVOL0
**** Loud**



@GRBVOL1
Medium



@GRBVOL2
Low

Good Read Vibration



@GRVENA1
**** On**



@GRVENA0
Off

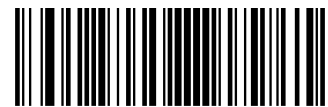

@SETUPE0
**** Exit Setup**



@SETUPE1
Enter Setup

Good Read Vibration Duration

This parameter sets the length of the vibration the engine emits on a good read. It is programmable in 1ms increments from 100ms to 2000ms. The default setting is 300ms.



@GRVDUR
Good Read Vibration Duration

E
sample

Set the Good Read Vibration duration to 800ms:

1. Scan the **Enter Setup** barcode.
2. Scan the **Good Read Vibration Duration** barcode.
3. Scan the numeric barcodes “8”, “0” and “0” from the “Digit Barcodes” section in Appendix.
4. Scan the **Save** barcode from the “Save/Cancel Barcodes” section in Appendix.
5. Scan the **Exit Setup** barcode.

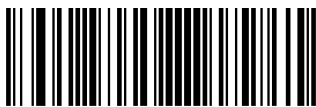

@SETUPE0
**** Exit Setup**



@SETUPE1
Enter Setup

Scan Mode

- ✧ **Level Mode:** A trigger pull activates a decode session. The decode session continues until a barcode is decoded or you release the trigger.
- ✧ **Sense Mode:** The scanner waits for the image stabilization timeout to expire before activating a decode session every time it detects a change in ambient illumination. Decode session continues until a barcode is decoded or the decode session timeout expires. In this mode, a trigger pull can also activate a decode session. The decode session continues until a barcode is decoded or the trigger is released. When the session ends, the scanner continues to monitor ambient illumination. **Timeout between Decodes (Same Barcode)** can avoid undesired rereading of same barcode in a given period of time. **Sensitivity** can change the Sense Mode's sensibility to changes in ambient illumination.
- ✧ **Continuous Mode:** The scanner automatically starts one decode session after another. To suspend/resume barcode reading, simply press the trigger. **Timeout between Decodes (Same Barcode)** can avoid undesired rereading of same barcode in a given period of time.



@SCNMOD0
** Level Mode



@SCNMOD2
Sense Mode



@SCNMOD3
Continuous Mode

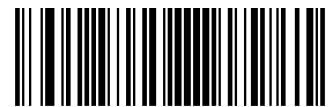

@SETUPE0
** Exit Setup



@SETUPE1
Enter Setup

Decode Session Timeout

This parameter sets the maximum time decode session continues during a scan attempt. It is programmable in 1ms increments from 1ms to 3,600,000ms. When it is set to 0, the timeout is infinite. The default setting is 3,000ms.

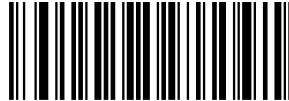

@ORTSET
Decode Session Timeout

E
example

Set the decode session timeout to 1,500ms:

1. Scan the **Enter Setup** barcode.
2. Scan the **Decode Session Timeout** barcode.
3. Scan the numeric barcodes “1”, “5”, “0” and “0” from the “Digit Barcodes” section in Appendix.
4. Scan the **Save** barcode from the “Save/Cancel Barcodes” section in Appendix.
5. Scan the **Exit Setup** barcode.



@SETUPE0
**** Exit Setup**



@SETUPE1
Enter Setup

Image Stabilization Timeout (Sense Mode)

This parameter defines the amount of time the scanner will spend adapting to ambient environment after it decodes a barcode and “looks” for another. It is programmable in 1ms increments from 1ms to 3,000ms. The default setting is 200ms.



@SENIST
Image Stabilization Timeout

E
xample

Set the image stabilization timeout to 800ms:

1. Scan the **Enter Setup** barcode.
2. Scan the **Image Stabilization Timeout** barcode.
3. Scan the numeric barcodes “8”, “0” and “0” from the “Digit Barcodes” section in Appendix.
4. Scan the **Save** barcode from the “Save/Cancel Barcodes” section in Appendix.
5. Scan the **Exit Setup** barcode.

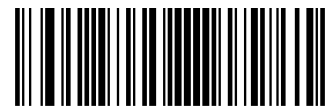

@SETUPE0
**** Exit Setup**



@SETUPE1
Enter Setup

Timeout between Decodes (Same Barcode)

Timeout between Decodes (Same Barcode) can avoid undesired rereading of same barcode in a given period of time. This feature is only applicable to the Sense and Continuous modes.

To enable/disable the Timeout between Decodes (Same Barcode), scan the appropriate barcode below.

Enable Timeout between Decodes (Same Barcode): Do not allow the scanner to re-read same barcode before the timeout between decodes (same barcode) expires.

Disable Timeout between Decodes (Same Barcode): Allow the scanner to re-read same barcode.



@RRDENA1

Enable Timeout between Decodes (Same Barcode)



@RRDENA0

**** Disable Timeout between Decodes (Same Barcode)**

The following parameter sets the timeout between decodes for same barcode. It is programmable in 1ms increments from 1ms to 3,600,000ms. When it is set to a value greater than 3,000, the timeout for rereading same programming barcode is limited to 3,000ms. The default setting is 1,500ms.



@RRDDUR

Timeout between Decodes (Same Barcode)

E
xample

Set the timeout between decodes (same barcode) to 1,000ms:

1. Scan the **Enter Setup** barcode.
2. Scan the **Timeout between Decodes (Same Barcode)** barcode.
3. Scan the numeric barcodes “1”, “0”, “0” and “0” from the “Digit Barcodes” section in Appendix.
4. Scan the **Save** barcode from the “Save/Cancel Barcodes” section in Appendix.
5. Scan the **Exit Setup** barcode.



@SETUPE0
**** Exit Setup**



@SETUPE1
Enter Setup

Reread Timeout Reset



@RRDREN1
On



@RRDREN0
** Off

Image Decoding Timeout

Image Decoding Timeout specifies the maximum time the scanner will spend decoding an image. This parameter is programmable in 1ms increments from 1ms to 3,000ms. The default timeout is 500ms.



@DETSET
Image Decoding Timeout

E
xample

Set the image decoding timeout to 1,000ms:

1. Scan the **Enter Setup** barcode.
2. Scan the **Image Decoding Timeout** barcode.
3. Scan the numeric barcodes “1”, “0”, “0” and “0” from the “Digit Barcodes” section in Appendix.
4. Scan the **Save** barcode from the “Save/Cancel Barcodes” section in Appendix.
5. Scan the **Exit Setup** barcode.

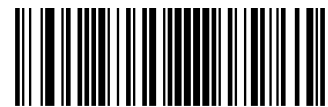

@SETUPE0
** Exit Setup



@SETUPE1
Enter Setup

Sensitivity

Sensitivity specifies the degree of acuteness of the scanner's response to changes in images captured. The higher the sensitivity, the lower requirement in image change to trigger the scanner. You can select an appropriate degree of sensitivity that fits the application environment. The feature is only applicable to the Sense mode.



@SENLVL14
Low Sensitivity



@SENLVL11
Medium Sensitivity



@SENLVL8
High Sensitivity



@SENLVL5
** Enhanced Sensitivity



@SENLVL
Custom Sensitivity (Level 1-20)

E
sample

Set the sensitivity to Level 10:

1. Scan the **Enter Setup** barcode.
2. Scan the **Custom Sensitivity** barcode.
3. Scan the numeric barcodes "1" and "0" from the "Digit Barcodes" section in Appendix.
4. Scan the **Save** barcode from the "Save/Cancel Barcodes" section in Appendix.
5. Scan the **Exit Setup** barcode.



@SETUPE0
** Exit Setup



@SETUPE1
Enter Setup

Trigger Commands

When **Enable Trigger Commands** is selected, you can activate and deactivate the scanner in the Level mode with serial trigger commands. Sending the **Start Scanning** command (default: <SOH> T <EOT>, user-programmable) to the scanner in the Level mode activates a decode session. The decode session continues until a barcode is decoded or the decode session timeout expires or the scanner receives the **Stop Scanning** command (default: <SOH> P <EOT>, user-programmable).



@SCNTCE0
**** Disable Trigger Commands**



@SCNTCE1
Enable Trigger Commands

Modify Start Scanning Command

The **Start Scanning** command can consist of 1-10 characters (HEX values from 0x01 to 0xFF). In this command, the character “?” (HEX: 0x3F) cannot be the first character. The default **Start Scanning** command is <SOH> T <EOT>.



@SCNTCT
Modify Start Scanning Command

E
xample

Set the Start Scanning command to “*T”:

1. Scan the **Enter Setup** barcode.
2. Scan the **Modify Start Scanning Command** barcode.
3. Scan the numeric barcodes “2”, “A”, “5” and “4” from the “Digit Barcodes” section in Appendix.
4. Scan the **Save** barcode from the “Save/Cancel Barcodes” section in Appendix.
5. Scan the **Exit Setup** barcode.



@SETUPE0
**** Exit Setup**



@SETUPE1
Enter Setup

Modify Stop Scanning Command

The **Stop Scanning** command can consist of 1-10 characters (HEX values from 0x01 to 0xFF). In this command, the character “?” (HEX: 0x3F) cannot be the first character. The default **Stop Scanning** command is **<SOH> P <EOT>**.



@SCNTCP
Modify Stop Scanning Command

E
xample

Set the **Stop Scanning** command to “*P”:

1. Scan the **Enter Setup** barcode.
2. Scan the **Modify Stop Scanning Command** barcode.
3. Scan the numeric barcodes “2”, “A”, “5” and “0” from the “Digit Barcodes” section in Appendix.
4. Scan the **Save** barcode from the “Save/Cancel Barcodes” section in Appendix.
5. Scan the **Exit Setup** barcode.



@SETUPE0
**** Exit Setup**



@SETUPE1
Enter Setup

Scanning Preference

Normal Mode: Select this mode when reading barcodes on paper.

Screen Mode: Select this mode when reading barcodes on the screen.

Barcode Pay Mode: Select this mode for barcode pay.



@EXPLVL0
**** Normal Mode**



@EXPLVL2
Screen Mode



@EXPLVL5
Barcode Pay Mode

Read Barcode On/Off

Sending the Read Barcode Off command `~<SOH>0000#SCNENA0;<ETX>` to the scanner can disable it from reading barcode, and the scanner is unable to scan barcode unless you send the Read Barcode On command `~<SOH>0000#SCNENA1;<ETX>` to it or power cycle it. By default, Read Barcode is On.

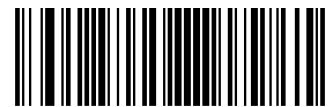

@SETUPE0
**** Exit Setup**



@SETUPE1
Enter Setup

Decode Area

Whole Area Decoding: The scanner attempts to decode barcode(s) within its field of view, from the center to the periphery, and transmits the barcode that has been first decoded.

Specific Area Decoding: The scanner attempts to read barcode(s) within a specified decoding area and transmits the barcode that has been first decoded. This option allows the scanner to narrow its field of view to make sure it reads only those barcodes intended by the user. For instance, if multiple barcodes are placed closely together, specific area decoding in conjunction with appropriate pre-defined decoding area will insure that only the desired barcode is read.



** Whole Area Decoding



Specific Area Decoding

If **Specific Area Decoding** is enabled, the scanner only reads barcodes that intersect the predefined decoding area. The default decoding area is an area of 40% top, 60% bottom, 40% left and 60% right of the scanner's field of view

You can define the decoding area using the **Top of Decoding Area**, **Bottom of Decoding Area**, **Left of Decoding Area** and **Right of Decoding Area** barcodes as well as numeric barcode(s) that represent(s) a desired percentage (0-100). The value of Bottom must be greater than that of Top; the value of Right must be greater than that of Left.



Top of Decoding Area



Bottom of Decoding Area



Left of Decoding Area



Right of Decoding Area



@SETUPE0
** Exit Setup



@SETUPE1
Enter Setup



Example

Program the scanner to only read Barcode 1 in the figure above by setting the decoding area to 10% top, 45% bottom, 15% left and 30% right:

1. Scan the **Enter Setup** barcode.
2. Scan the **Top of Decoding Area** barcode.
3. Scan the numeric barcode "0" from the "Digit Barcodes" section in Appendix.
4. Scan the **Save** barcode from the "Save/Cancel Barcodes" section in Appendix.
5. Scan the **Bottom of Decoding Area** barcode.
6. Scan the numeric barcodes "4" and "5" from the "Digit Barcodes" section in Appendix.
7. Scan the **Save** barcode from the "Save/Cancel Barcodes" section in Appendix.
8. Scan the **Top of Decoding Area** barcode.
9. Scan the numeric barcodes "1" and "0" from the "Digit Barcodes" section in Appendix.
10. Scan the **Save** barcode from the "Save/Cancel Barcodes" section in Appendix.
11. Scan the **Left of Decoding Area** barcode.
12. Scan the numeric barcode "0" from the "Digit Barcodes" section in Appendix.
13. Scan the **Save** barcode from the "Save/Cancel Barcodes" section in Appendix.
14. Scan the **Right of Decoding Area** barcode.
15. Scan the numeric barcodes "3" and "0" from the "Digit Barcodes" section in Appendix.
16. Scan the **Save** barcode from the "Save/Cancel Barcodes" section in Appendix.
17. Scan the **Left of Decoding Area** barcode.
18. Scan the numeric barcodes "1" and "5" from the "Digit Barcodes" section in Appendix.
19. Scan the **Save** barcode from the "Save/Cancel Barcodes" section in Appendix.
20. Scan the **Exit Setup** barcode.

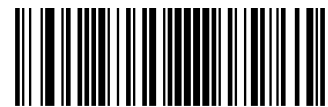

@SETUPE0
** Exit Setup



@SETUPE1
Enter Setup

Image Flipping



@MIRROR0
** Do Not Flip



@MIRROR1
Flip Horizontally



@MIRROR2
Flip Vertically



@MIRROR3
Flip Horizontally & Vertically

Example of image not flipped



Example of image flipped vertically

Example of image flipped horizontally



Example of image flipped horizontally & vertically



@SETUPE0
** Exit Setup



@SETUPE1
Enter Setup



Bad Read Message

Scan the appropriate barcode below to select whether or not to send a bad read message (user-programmable) when a good read does not occur before trigger release, or the decode session timeout expires, or the scanner receives the **Stop Scanning** command (For more information, see the “Serial Trigger Command” section in this chapter).



** Bad Read Message OFF



Bad Read Message ON

Set Bad Read Message

A bad read message can contain up to 7 characters (HEX values from 0x00 to 0xFF). To set a bad read message, scan the **Set Bad Read Message** barcode, the numeric barcodes representing the hexadecimal values of desired character(s) and the **Save** barcode. The default setting is “NG”.



Set Bad Read Message

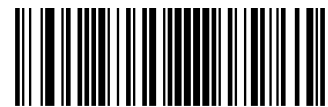

@SETUPE0
** Exit Setup



@SETUPE1
Enter Setup

E
example

Set the bad read message to “F” (HEX: 0x46):

1. Scan the **Enter Setup** barcode.
2. Scan the **Set Bad Read Message** barcode.
3. Scan the numeric barcodes “4” and “6” from the “Digit Barcodes” section in Appendix.
4. Scan the **Save** barcode from the “Save/Cancel Barcodes” section in Appendix.
5. Scan the **Exit Setup** barcode.

Default Settings

Factory Defaults

Scanning the following barcode can restore the scanner to the factory defaults.

You may need to reset all parameters to the factory defaults when:

6. scanner is not properly configured so that it fails to decode barcodes.
7. you forget previous configuration and want to avoid its impact.



@FACDEF
Restore All Factory Defaults

Custom Defaults

Scanning the **Restore All Custom Defaults** barcode can reset all parameters to the custom defaults. Scanning the **Save as Custom Defaults** barcode can set the current settings as custom defaults.

Custom defaults are stored in the non-volatile memory.



@CUSSAV
Save as Custom Defaults



@SETUPE0
**** Exit Setup**



@SETUPE1

Enter Setup



@CUSDEF

Restore All Custom Defaults



Restoring the scanner to the factory defaults will not remove the custom defaults from the scanner.



@SETUPE0

**** Exit Setup**



@SETUPE1
Enter Setup

Query Product Information

After scanning the barcode below, the product information (including product name, firmware version, decoder version, hardware version, product serial number, OEM serial number and manufacturing date) will be sent to the host device.



@QRYSYS
Query Product Information

Query Product Name



@QRYPDN
Query Product Name

Query Firmware Version



@QRYFWW
Query Firmware Version



@SETUPE0
** Exit Setup



@SETUPE1
Enter Setup

Query Decoder Version



@QRYDCV
Query Decoder Version

Query Hardware Version



@QRYHWW
Query Hardware Version

Query Product Serial Number



@QRYPSN
Query Product Serial Number



@SETUPE0
**** Exit Setup**



@SETUPE1
Enter Setup

Query Manufacturing Date



@QRYDAT
Query Manufacturing Date

Query OEM Serial Number



@QRYESN
Query OEM Serial Number

Query Data Formatter Version



@QRYDFM
Query Data Formatter Version



@SETUPE0
** Exit Setup



@SETUPE1
Enter Setup

Chapter 3 USB Interface

Introduction

There are four options for USB connection:

- ✧ USB HID Keyboard: The scanner's transmission is simulated as USB keyboard input with no need for command configuration or a driver. Barcode data could be entered by the virtual keyboard directly and it is also convenient for the host device to receive data.
- ✧ USB CDC: It is compliant with the standard USB CDC class specifications defined by the USB-IF and allows the host device to receive data in the way as a serial port does. A driver is needed when using this feature.
- ✧ HID POS (POS HID Barcode Scanner): It is based on the HID interface, with no need for a custom driver. It excels virtual keyboard and traditional RS-232 interface in transmission speed.

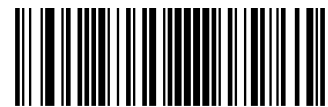

@SETUPE0
** Exit Setup



@SETUPE1
Enter Setup

USB HID Keyboard

When the scanner is connected to the USB port on a host device, you can enable the USB HID Keyboard feature by scanning the barcode below. Then scanner's transmission will be simulated as USB keyboard input. The Host receives keystrokes on the virtual keyboard. It works on a Plug and Play basis and no driver is required.



@INTERF3
USB HID Keyboard



If the host device allows keyboard input, then no extra software is needed for HID Keyboard input.



@SETUPE0
** Exit Setup



@SETUPE1
Enter Setup

USB Country Keyboard Types

Keyboard layouts vary from country to country. The default setting is U.S. keyboard.



@KBWCTY0
**** U.S. (English)**



@KBWCTY1
Belgium



@KBWCTY2
Brazil



@KBWCTY3
Canada (French)



@KBWCTY4
Czechoslovakia



@KBWCTY5
Denmark



@KBWCTY6
Finland (Swedish)

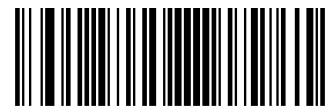

@SETUPE0
**** Exit Setup**



@SETUPE1
Enter Setup



@KBWCTY8
Germany/ Austria

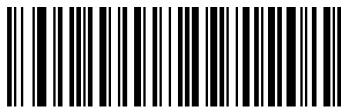

@KBWCTY10
Hungary



@KBWCTY12
Italy

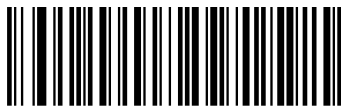

@KBWCTY14
Netherlands (Dutch)



@KBWCTY7
France



@KBWCTY9
Greece



@KBWCTY11
Israel (Hebrew)



@KBWCTY13
Latin America/ South America



@SETUPE0
**** Exit Setup**



@SETUPE1
Enter Setup



@KBWCTY15
Norway



@KBWCTY16
Poland



@KBWCTY17
Portugal



@KBWCTY18
Romania



@KBWCTY19
Russia



@KBWCTY21
Slovakia



@KBWCTY22
Spain



@KBWCTY23
Sweden

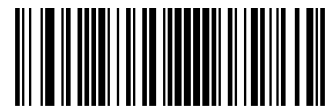

@SETUPE0
**** Exit Setup**



@SETUPE1
Enter Setup



@KBWCTY24
Switzerland (German)



@KBWCTY25
Turkey_F

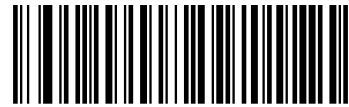

@KBWCTY26
Turkey_Q



@KBWCTY27
UK



@KBWCTY28
Japan



@SETUPE0
**** Exit Setup**



@SETUPE1
Enter Setup

Beep on Unknown Character

Due to the differences in keyboard layouts, some characters contained in barcode data may be unavailable on the selected keyboard. As a result, the scanner fails to transmit the unknown characters.

Scan the appropriate barcode below to enable or disable the emission of beep when an unknown character is detected.



@KBWBUC0

**** Do Not Beep on Unknown Character**



@KBWBUC1

Beep on Unknown Character

E *sample*

Supposing French keyboard (Country Code: 7) is selected and barcode data "AÐF" is being dealt with, the keyboard will fail to locate the "Ð" (0xD0) character and the scanner will ignore the character and continue to process the next one.

Do Not Beep on Unknown Character: The scanner does not beep and the Host receives "AF".

Beep on Unknown Character: The scanner beeps and the Host still receives "AF".



If **Emulate ALT+Keypad ON** is selected, **Beep on Unknown Character** does not function.



@SETUPE0
**** Exit Setup**



@SETUPE1
Enter Setup

Emulate ALT+Keypad

When **Emulate ALT+Keypad** is turned on, any character whose ASCII value is greater than or equal to 0x20 is sent over the numeric keypad no matter which keyboard type is selected.

1. ALT Make
2. Enter the number corresponding to a desired character on the keypad.
3. ALT Break

After **Emulate ALT+Keypad ON** is selected, you need to choose the code page with which the barcodes were created and to turn **Unicode Encoding** On or Off depending on the encoding used by the application software.



@KBWALTO
**** Emulate ALT+Keypad OFF**



Emulate ALT+Keypad ON



Since sending a character involves multiple keystroke emulations, this method appears less efficient.



Supposing **Emulate ALT+Keypad** is ON, **Unicode Encoding** is Off, **Code Page 1252 (West European Latin)** is selected, and **Emulate Keypad with Leading Zero** is Off, barcode data "ADF" (65/208/70) is sent as below:

"A" -- "ALT Make" + "065" + "ALT Break"

"D" -- "ALT Make" + "208" + "ALT Break"

"F" -- "ALT Make" + "070" + "ALT Break"



@SETUPE0
**** Exit Setup**



@SETUPE1
Enter Setup

Code Page

Code pages define the mapping of character codes to characters. If the data received does not display with the proper characters, it may be because the barcode being scanned was created using a code page that is different from the one the host program is expecting. If this is the case, select the code page with which the barcodes were created by scanning the appropriate barcode below. For PDF417, QR Code, Aztec and Data Matrix, besides setting the code page, you also need to set the character encoding in the “Character Encoding” section in Chapter 7. This feature is only effective when **Emulate ALT+Keypad** is turned on.



@KBWCPG0

**** Code Page 1252 (West European Latin)**

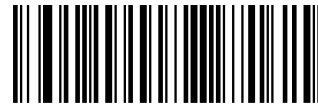

@KBWCPG1

Code Page 1251 (Cyrillic)



@KBWCPG2

Code Page 1250 (Central and East European Latin)



@KBWCPG3

Code Page 1253 (Greek)



@KBWCPG4

Code Page 1254 (Turkish)



@KBWCPG5

Code Page 1255 (Hebrew)

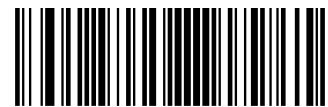

@SETUPE0
**** Exit Setup**



@SETUPE1
Enter Setup



@KBWCPG6
Code Page 1256 (Arabic)



@KBWCPG7
Code Page 1257 (Baltic)



@KBWCPG8
Code Page 1258 (Vietnamese)



@SETUPE0
**** Exit Setup**



@SETUPE1
Enter Setup

Unicode Encoding

Different host program may use different character encodings for handling incoming barcode data. For instance, Microsoft Office Word uses Unicode encoding and therefore you should turn **Unicode Encoding** on, whereas Microsoft Office Excel or Notepad uses Code Page encoding and therefore you should turn **Unicode Encoding** off. This feature is only effective when **Emulate ALT+Keypad** is turned on.



@KBWCPU0
** Off



@KBWCPU1
On

Emulate Keypad with Leading Zero

You may turn this feature on to send character sequences sent over the numeric keypad as ISO characters which have a leading zero. For example, ASCII A transmits as "ALT MAKE" 0065 "ALT BREAK". This feature is only effective when **Emulate ALT+Keypad** is enabled.



@KBWALZ1
** On



@KBWALZ0
Off

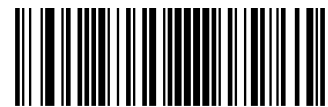

@SETUPE0
** Exit Setup



@SETUPE1
Enter Setup

Function Key Mapping

When **Ctrl+ASCII Mode** is selected, function characters (0x00 - 0x1F) are sent as ASCII sequences.



@KBWFKM0
**** Disable**



@KBWFKM1
Ctrl+ASCII Mode



@KBWFKM2
Alt+Keypad Mode

Example

If **Ctrl+ASCII Mode** is selected and other parameters of USB HID Keyboard adopt factory defaults, barcode data “A<HT>(i.e. Horizontal Tab)F” (0x41/0x09/0x46) is sent as below:

“A” - Keystroke “A”.

<HT> - “Ctrl Make” + Keystroke “I” + “Ctrl Break”

“F” - Keystroke “F”

For some text editors, “Ctrl I” means italic convert. So the output may be “A*F*”.

If **Alt+Keypad Mode** is selected and other parameters of USB HID Keyboard adopt factory defaults, the data above is sent as below:

“A” - Keystroke “A”.

<HT> - “Alt Make” + Keystrokes “009” + “Alt Break”

“F” - Keystroke “F”



@SETUPE0
**** Exit Setup**



@SETUPE1
Enter Setup

ASCII Function Key Mapping Table

ASCII Function	ASCII Value (HEX)	Function Key Mapping Disabled	Ctrl+ASCII
NUL	00	Null	Ctrl+@
SOH	01	Keypad Enter	Ctrl+A
STX	02	Caps Lock	Ctrl+B
ETX	03	ALT	Ctrl+C
EOT	04	Null	Ctrl+D
ENQ	05	CTRL	Ctrl+E
ACK	06	Null	Ctrl+F
BEL	07	Enter	Ctrl+G
BS	08	Left Arrow	Ctrl+H
HT	09	Horizontal Tab	Ctrl+I
LF	0A	Down Arrow	Ctrl+J
VT	0B	Vertical Tab	Ctrl+K
FF	0C	Delete	Ctrl+L
CR	0D	Enter	Ctrl+M
SO	0E	Insert	Ctrl+N
SI	0F	Esc	Ctrl+O
DLE	10	F11	Ctrl+P
DC1	11	Home	Ctrl+Q
DC2	12	PrintScreen	Ctrl+R
DC3	13	Backspace	Ctrl+S
DC4	14	tab+shift	Ctrl+T
NAK	15	F12	Ctrl+U
SYN	16	F1	Ctrl+V
ETB	17	F2	Ctrl+W
CAN	18	F3	Ctrl+X
EM	19	F4	Ctrl+Y
SUB	1A	F5	Ctrl+Z
ESC	11	F6	Ctrl+[
FS	1C	F7	Ctrl+\
GS	1D	F8	Ctrl+]
RS	1E	F9	Ctrl+6
US	1F	F10	Ctrl+-

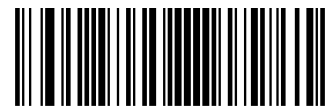

@SETUPE0
** Exit Setup



@SETUPE1
Enter Setup

ASCII Function Key Mapping Table (Continued)

The last five characters (0x1B~0x1F) in the table above apply to US keyboard layout only. The following chart provides the equivalents of these five characters for other countries.

Country	Ctrl+ASCII					
United States	Ctrl+[Ctrl+\	Ctrl+]	Ctrl+6	Ctrl+-	
Belgium	Ctrl+[Ctrl+<	Ctrl+]	Ctrl+6	Ctrl+-	
Scandinavia	Ctrl+8	Ctrl+<	Ctrl+9	Ctrl+6	Ctrl+-	
France	Ctrl+^	Ctrl+8	Ctrl+\$	Ctrl+6	Ctrl+=	
Germany		Ctrl+Ã	Ctrl++	Ctrl+6	Ctrl+-	
Italy		Ctrl+\	Ctrl++	Ctrl+6	Ctrl+-	
Switzerland		Ctrl+<	Ctrl+..	Ctrl+6	Ctrl+-	
United Kingdom	Ctrl+[Ctrl+∅	Ctrl+]	Ctrl+6	Ctrl+-	
Denmark	Ctrl+8	Ctrl+\	Ctrl+9	Ctrl+6	Ctrl+-	
Norway	Ctrl+8	Ctrl+\	Ctrl+9	Ctrl+6	Ctrl+-	
Spain	Ctrl+[Ctrl+\	Ctrl+]	Ctrl+6	Ctrl+-	



@SETUPE0
** Exit Setup



@SETUPE1
Enter Setup

Inter-Keystroke Delay

This parameter specifies the delay between emulated keystrokes.



@KBWDLY0
**** No Delay**



@KBWDLY40
Long Delay (40ms)



@KBWDLY20
Short Delay (20ms)

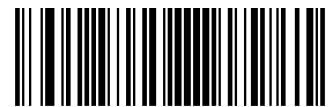

@SETUPE0
**** Exit Setup**



@SETUPE1
Enter Setup

Caps Lock

The **Caps Lock On** options can invert upper and lower case characters contained in barcode data. This inversion occurs regardless of the state of Caps Lock key on the host device's keyboard. To disable this feature, scan the appropriate **Caps Lock OFF** barcode below based on your keyboard.



@KBWCAP0

** Caps Lock Off, Non-Japanese Keyboard



@KBWCAP1

Caps Lock On, Non-Japanese Keyboard



Emulate ALT+Keypad ON/ Convert All to Upper Case/ Convert All to Lower Case prevails over Caps Lock ON.



When the **Caps Lock ON** feature is selected, barcode data "AbC" is transmitted as "aBc".

Convert Case

Scan the appropriate barcode below to convert all bar code data to your desired case.



@KBWCAS0

** No Case Conversion



@KBWCAS1

Convert All to Upper Case



@SETUPE0

** Exit Setup



@SETUPE1

Enter Setup



@KBWCAS2

Convert All to Lower Case

E
xample

When the **Convert All to Lower Case** feature is enabled, barcode data “AbC” is transmitted as “abc”.



If **Emulate ALT+Keypad ON** is selected, **Convert All to Lower Case** and **Convert All to Upper Case** do not function.

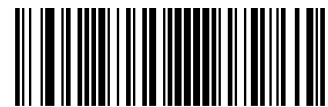

@SETUPE0

**** Exit Setup**



@SETUPE1
Enter Setup

Emulate Numeric Keypad



Do Not Emulate Numeric Keypad 1: Sending a number (0-9) is emulated as keystroke(s) on main keyboard.

Emulate Numeric Keypad 1: Sending a number (0-9) is emulated as keystroke(s) on numeric keypad. The state of Num Lock on the simulated numeric keypad is determined by its equivalent on the host device. If Num Lock on the host device is turned off, the output of simulated numeric keypad is function key instead of number.

Do Not Emulate Numeric Keypad 2: Sending “+”, “-”, “*” and “/” is emulated as keystroke(s) on main keyboard.

Emulate Numeric Keypad 2: Sending “+”, “-”, “*” and “/” is emulated as keystroke(s) on numeric keypad.



@KBWNUM0

**** Do Not Emulate Numeric Keypad 1**



@KBWNUM1

Emulate Numeric Keypad 1



@SETUPE0
**** Exit Setup**



@SETUPE1
Enter Setup



@KBWNCH0

**** Do Not Emulate Numeric Keypad 2**



@KBWNCH1

Emulate Numeric Keypad 2



Emulate ALT+Keypad ON prevails over **Emulate Numeric Keypad**.

E
example

Supposing the **Emulate Numeric Keypad 1** and **Emulate Numeric Keypad 2** features are enabled:

if Num Lock on the host device is ON, "A4.5" is transmitted as "A4.5";

if Num Lock on the host device is OFF, "A4.5" is transmitted as follows:

1. "A" is sent as is because it is not included in numeric keypad;
2. "4" is sent as the function key "Cursor Move to Left";
3. "." is sent as the function key "Delete After the Cursor";
4. "5" is not sent as it does not correspond to any function key.



@SETUPE0
**** Exit Setup**



@SETUPE1
Enter Setup

Fast Mode

When **Fast Mode On** is selected, the scanner sends characters to the Host faster. If the Host drops characters, turn the Fast Mode off or change the polling rate to a bigger value.



@KBWFAS0
**** Fast Mode Off**



@KBWFAS1
Fast Mode On



@SETUPE0
**** Exit Setup**



@SETUPE1
Enter Setup

Polling Rate

This parameter specifies the polling rate for a USB keyboard. If the Host drops characters, change the polling rate to a bigger value.



@KBWPOR0
1ms



@KBWPOR1
2ms



@KBWPOR2
3ms



@KBWPOR3
**** 4ms**



@KBWPOR4
5ms



@KBWPOR5
6ms



@KBWPOR6
7ms

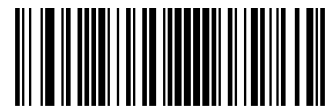

@SETUPE0
**** Exit Setup**



@SETUPE1
Enter Setup



@KBWPOR7
8ms



@KBWPOR8
9ms



@KBWPOR9
10ms



@SETUPE0
**** Exit Setup**



@SETUPE1
Enter Setup

USB CDC

If your scanner is connected to the USB port on a host device, the USB CDC feature allows the host device to receive data in the way as a serial port does. A driver is needed when using this feature.



@INTERF8
**** USB CDC**

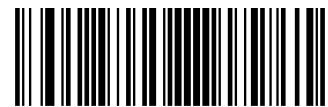

@SETUPE0
**** Exit Setup**



@SETUPE1
Enter Setup

HID POS (POS HID Barcode Scanner)

Introduction

The HID-POS interface is recommended for new application programs. It can send up to 56 characters in a single USB report and appears more efficient than keyboard emulation.

Features:

1. HID based, no custom driver required.
2. Way more efficient in communication than keyboard emulation and traditional RS-232 interface.



@INTERF5
USB HID-POS

Access the Scanner with Your Program

Use CreateFile to access the scanner as a HID device and then use ReadFile to deliver the scanned data to the application program. Use WriteFile to send data to the scanner.

For detailed information about USB and HID interfaces, go to www.USB.org.



@SETUPE0
** Exit Setup



@SETUPE1
Enter Setup

Acquire Scanned Data

After a barcode is decoded, the scanner sends an input report as below:

Byte	Bit							
	7	6	5	4	3	2	1	0
0	Report ID = 0x02							
1	Barcode Length							
2-57	Decoded Data (1-56)							
58-61	Reserved							
62	Symbology Identifier or N/C: 0x00							
63	-	-	-	-	-	-	-	Decoded data continued

Send Command to the Scanner

This output report is used to send commands to the scanner. All programming commands can be used.

Byte	Bit							
	7	6	5	4	3	2	1	0
0	Report ID = 0x04							
1	Length of command							
2-63	Command (1-62)							

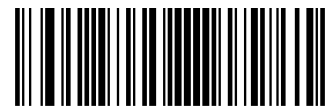

@SETUPE0
** Exit Setup



@SETUPE1
Enter Setup

VID/PID

USB uses VID (Vendor ID) and PID (Product ID) to identify and locate a device. The VID is assigned by USB Implementers Forum. The vendor ID is 1EAB (Hex). A range of PIDs are used for each product family. Every PID contains a base number and interface type (keyboard, COM port, etc.).

Product	Interface	PID (Hex)	PID (Dec)
The scanner	USB HID Keyboard	1A03	6659
	USB CDC	1A06	6662
	HID POS	1A10	6672



@SETUPE0
** Exit Setup



Chapter 4 Symbologies

Introduction

Every symbology (barcode type) has its own unique attributes. This chapter provides programming barcodes for configuring the scanner so that it can identify various symbologies. It is recommended to disable those that are rarely used to increase the efficiency of the scanner.

Global Settings

Enable/Disable All Symbologies

If the **Disable All Symbologies** feature is enabled, the scanner will not be able to read any non-programming barcodes except the programming barcodes.



Enable/Disable 1D Symbologies





@SETUPE1
Enter Setup



@ALL1DC0
Disable 1D Symbologies

Enable/Disable 2D Symbologies



@ALL2DC1
Enable 2D Symbologies



@ALL2DC0
Disable 2D Symbologies

1D Twin Code

1D twin code is two 1D barcodes of a symbology or of different symbologies paralleled vertically. Both barcodes must have similar specifications and be placed closely together.

There are 3 options for reading 1D twin code:

Single 1D Code Only: Read either 1D code.

Twin 1D Code Only: Read both 1D codes. Transmission sequence: upper 1D code followed by lower 1D code.

Both Single & Twin: Read both 1D codes. If successful, transmit as twin 1D code only. Otherwise, try single 1D code only.



@A1DDOU0
**** Single 1D Code Only**



@SETUPE0
**** Exit Setup**



@SETUPE1

Enter Setup



@A1DDOU2

Twin 1D Code Only



@A1DDOU1

Both Single & Twin

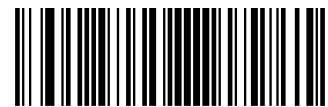

@SETUPE0

**** Exit Setup**



@SETUPE1
Enter Setup

Code 128

Restore Factory Defaults



@128DEF
Restore the Factory Defaults of Code 128

Enable/Disable Code 128



@128ENA1
**** Enable Code 128**



@128ENA0
Disable Code 128



If the scanner fails to identify Code 128 barcodes, you may first try this solution by scanning the **Enter Setup** barcode and then **Enable Code 128** barcode.



@SETUPE0
**** Exit Setup**



@SETUPE1
Enter Setup

Set Length Range for Code 128

The scanner can be configured to only decode Code 128 barcodes with lengths that fall between (inclusive) the minimum and maximum lengths. To accomplish it, you need to set the minimum and maximum lengths.



@128MIN

Set the Minimum Length (Default: 1)



@128MAX

Set the Maximum Length (Default: 48)



If minimum length is set to be greater than maximum length, the scanner only decodes Code 128 barcodes with either the minimum or maximum length. If minimum length is same as maximum length, only Code 128 barcodes with that length are to be decoded.



Set the scanner to decode Code 128 barcodes containing between 8 and 12 characters:

1. Scan the **Enter Setup** barcode.
2. Scan the **Set the Minimum Length** barcode.
3. Scan the numeric barcode "8" from the "Digit Barcodes" section in Appendix.
4. Scan the **Save** barcode from the "Save/Cancel Barcodes" section in Appendix.
5. Scan the **Set the Maximum Length** barcode.
6. Scan the numeric barcodes "1" and "2" from the "Digit Barcodes" section in Appendix.
7. Scan the **Save** barcode from the "Save/Cancel Barcodes" section in Appendix.
8. Scan the **Exit Setup** barcode.

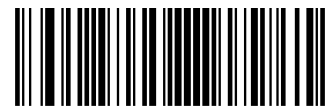

@SETUPE0
**** Exit Setup**



@SETUPE1
Enter Setup

EAN-8

Restore Factory Defaults



@EA8DEF

Restore the Factory Defaults of EAN-8

Enable/Disable EAN-8



@EA8ENA1

** Enable EAN-8



@EA8ENA0

Disable EAN-8



If the scanner fails to identify EAN-8 barcodes, you may first try this solution by scanning the **Enter Setup** barcode and then **Enable EAN-8** barcode.

Transmit Check Character

EAN-8 is 8 digits in length with the last one as its check character used to verify the integrity of the data.



@EA8CHK2

** Transmit EAN-8 Check Character



@EA8CHK1

Do Not Transmit EAN-8 Check Character



@SETUPE0

** Exit Setup



@SETUPE1

Enter Setup

2-Digit Add-On Code

An EAN-8 barcode can be augmented with a two-digit add-on code to form a new one. In the example below, the part surrounded by blue dotted line is an EAN-8 barcode while the part circled by red dotted line is a two-digit add-on code.



@EA8AD20

** Disable 2-Digit Add-On Code



@EA8AD21

Enable 2-Digit Add-On Code



Disable 2-Digit Add-On Code: The scanner decodes EAN-8 and ignores the add-on code when presented with an EAN-8 plus 2-digit add-on barcode. It can also decode EAN-8 barcodes without 2-digit add-on codes.

Enable 2-Digit Add-On Code: The scanner decodes a mix of EAN-8 barcodes with and without 2-digit add-on codes.

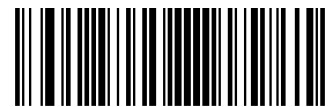

@SETUPE0

** Exit Setup



@SETUPE1
Enter Setup

5-Digit Add-On Code

An EAN-8 barcode can be augmented with a five-digit add-on code to form a new one. In the example below, the part surrounded by blue dotted line is an EAN-8 barcode while the part circled by red dotted line is a five-digit add-on code.



@EA8AD50

**** Disable 5-Digit Add-On Code**



@EA8AD51

Enable 5-Digit Add-On Code



Disable 5-Digit Add-On Code: The scanner decodes EAN-8 and ignores the add-on code when presented with an EAN-8 plus 5-digit add-on barcode. It can also decode EAN-8 barcodes without 5-digit add-on codes.

Enable 5-Digit Add-On Code: The scanner decodes a mix of EAN-8 barcodes with and without 5-digit add-on codes.



@SETUPE0
**** Exit Setup**



@SETUPE1
Enter Setup

Convert EAN-8 to EAN-13

Convert EAN-8 to EAN-13: Convert EAN-8 decoded data to EAN-13 format before transmission. After conversion, the data follows EAN-13 format and is affected by EAN-13 programming selections (e.g., Check Character).

Do Not Convert EAN-8 to EAN-13: EAN-8 decoded data is transmitted as EAN-8 data, without conversion.



@EA8EXP0

**** Do Not Convert EAN-8 to EAN-13**



@EA8EXP1

Convert EAN-8 to EAN-13



@SETUPE0
**** Exit Setup**



@SETUPE1
Enter Setup

EAN-13

Restore Factory Defaults



@E13DEF
Restore the Factory Defaults of EAN-13

Enable/Disable EAN-13



@E13ENA1
** Enable EAN-13



@E13ENA0
Disable EAN-13



If the scanner fails to identify EAN-13 barcodes, you may first try this solution by scanning the **Enter Setup** barcode and then **Enable EAN-13** barcode.



@SETUPE0
** Exit Setup



@SETUPE1
Enter Setup

Transmit Check Character



@E13CHK2

**** Transmit EAN-13 Check Character**



@E13CHK1

Do Not Transmit EAN-13 Check Character

2-Digit Add-On Code

An EAN-13 barcode can be augmented with a two-digit add-on code to form a new one. In the example below, the part surrounded by blue dotted line is an EAN-13 barcode while the part circled by red dotted line is a two-digit add-on code.



@E13AD20

**** Disable 2-Digit Add-On Code**



@E13AD21

Enable 2-Digit Add-On Code



Disable 2-Digit Add-On Code: The scanner decodes EAN-13 and ignores the add-on code when presented with an EAN-13 plus 2-digit add-on barcode. It can also decode EAN-13 barcodes without 2-digit add-on codes.

Enable 2-Digit Add-On Code: The scanner decodes a mix of EAN-13 barcodes with and without 2-digit add-on codes.

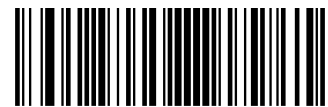

@SETUPE0
**** Exit Setup**



@SETUPE1
Enter Setup

5-Digit Add-On Code

An EAN-13 barcode can be augmented with a five-digit add-on code to form a new one. In the example below, the part surrounded by blue dotted line is an EAN-13 barcode while the part circled by red dotted line is a five-digit add-on code.



**** Disable 5-Digit Add-On Code**



Enable 5-Digit Add-On Code



Disable 5-Digit Add-On Code: The scanner decodes EAN-13 and ignores the add-on code when presented with an EAN-13 plus 5-digit add-on barcode. It can also decode EAN-13 barcodes without 5-digit add-on codes.

Enable 5-Digit Add-On Code: The scanner decodes a mix of EAN-13 barcodes with and without 5-digit add-on codes.

UPC-E

Restore Factory Defaults



Restore the Factory Defaults of UPC-E



@SETUPE0
**** Exit Setup**



@SETUPE1
Enter Setup

Enable/Disable UPC-E



@UPEEN01
**** Enable UPC-E0**



@UPEEN00
Disable UPC-E0



@UPEEN11
Enable UPC-E1



@UPEEN10
**** Disable UPC-E1**



If the scanner fails to identify UPC-E0/UPC-E1 barcodes, you may first try this solution by scanning the **Enter Setup** barcode and then **Enable UPC-E0/UPC-E1** barcode.



@SETUPE0
**** Exit Setup**



@SETUPE1
Enter Setup

Transmit Check Character

UPC-E is 8 digits in length with the last one as its check character used to verify the integrity of the data.



@UPECHK2

**** Transmit UPC-E Check Character**



@UPECHK1

Do Not Transmit UPC-E Check Character

2-Digit Add-On Code

A UPC-E barcode can be augmented with a two-digit add-on code to form a new one. In the example below, the part surrounded by blue dotted line is a UPC-E barcode while the part circled by red dotted line is a two-digit add-on code.



@UPEAD20

**** Disable 2-Digit Add-On Code**



@UPEAD21

Enable 2-Digit Add-On Code



Disable 2-Digit Add-On Code: The scanner decodes UPC-E and ignores the add-on code when presented with a UPC-E plus 2-digit add-on barcode. It can also decode UPC-E barcodes without 2-digit add-on codes.

Enable 2-Digit Add-On Code: The scanner decodes a mix of UPC-E barcodes with and without 2-digit add-on codes.



@SETUPE0

**** Exit Setup**



@SETUPE1
Enter Setup

5-Digit Add-On Code

A UPC-E barcode can be augmented with a five-digit add-on code to form a new one. In the example below, the part surrounded by blue dotted line is a UPC-E barcode while the part circled by red dotted line is a five-digit add-on code.

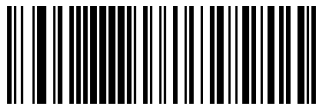

@UPEAD50

**** Disable 5-Digit Add-On Code**



@UPEAD51

Enable 5-Digit Add-On Code



Disable 5-Digit Add-On Code: The scanner decodes UPC-E and ignores the add-on code when presented with a UPC-E plus 5-digit add-on barcode. It can also decode UPC-E barcodes without 5-digit add-on codes.

Enable 5-Digit Add-On Code: The scanner decodes a mix of UPC-E barcodes with and without 5-digit add-on codes.

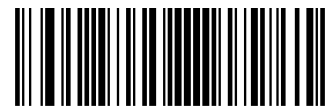

@SETUPE0
**** Exit Setup**



@SETUPE1
Enter Setup

Transmit Preamble Character

Preamble characters (Country Code and System Character) can be transmitted as part of a UPC-E barcode. Select one of the following options for transmitting UPC-E preamble to the host device: transmit system character only, transmit system character and country code ("0" for USA), or transmit no preamble.



@UPEPRE1
**** System Character**



@UPEPRE0
No Preamble



@UPEPRE2
System Character & Country Code

Convert UPC-E to UPC-A

Convert UPC-E to UPC-A: Convert UPC-E (zero suppressed) decoded data to UPC-A format before transmission. After conversion, the data follows UPC-A format and is affected by UPC-A programming selections (e.g., Preamble, Check Character).

Do Not Convert UPC-E to UPC-A: UPC-E decoded data is transmitted as UPC-E data, without conversion.



@UPEEXP0
**** Do Not Convert UPC-E to UPC-A**



@UPEEXP1
Convert UPC-E to UPC-A



@SETUPE0
**** Exit Setup**



@SETUPE1
Enter Setup

UPC-A

Restore Factory Defaults

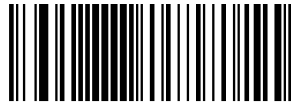

@UPADEF

Restore the Factory Defaults of UPC-A

Enable/Disable UPC-A



@UPAENA1

**** Enable UPC-A**



@UPAENA0

Disable UPC-A



If the scanner fails to identify UPC-A barcodes, you may first try this solution by scanning the **Enter Setup** barcode and then **Enable UPC-A** barcode.

Transmit Check Character

UPC-A is 13 digits in length with the last one as its check character used to verify the integrity of the data.

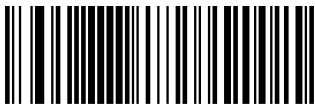

@UPACHK2

**** Transmit UPC-A Check Character**



@UPACHK1

Do Not Transmit UPC-A Check Character

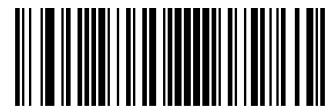

@SETUPE0

**** Exit Setup**



@SETUPE1
Enter Setup

2-Digit Add-On Code

A UPC-A barcode can be augmented with a two-digit add-on code to form a new one. In the example below, the part surrounded by blue dotted line is a UPC-A barcode while the part circled by red dotted line is a two-digit add-on code.



@UPAAD20
**** Disable 2-Digit Add-On Code**



@UPAAD21
Enable 2-Digit Add-On Code



Disable 2-Digit Add-On Code: The scanner decodes UPC-A and ignores the add-on code when presented with a UPC-A plus 2-digit add-on barcode. It can also decode UPC-A barcodes without 2-digit add-on codes.

Enable 2-Digit Add-On Code: The scanner decodes a mix of UPC-A barcodes with and without 2-digit add-on codes.



@SETUPE0
**** Exit Setup**



@SETUPE1
Enter Setup

5-Digit Add-On Code

A UPC-A barcode can be augmented with a five-digit add-on code to form a new one. In the example below, the part surrounded by blue dotted line is a UPC-A barcode while the part circled by red dotted line is a five-digit add-on code.



**** Disable 5-Digit Add-On Code**



Enable 5-Digit Add-On Code



Disable 5-Digit Add-On Code: The scanner decodes UPC-A and ignores the add-on code when presented with a UPC-A plus 5-digit add-on barcode. It can also decode UPC-A barcodes without 5-digit add-on codes.

Enable 5-Digit Add-On Code: The scanner decodes a mix of UPC-A barcodes with and without 5-digit add-on codes.



@SETUPE0
**** Exit Setup**



@SETUPE1
Enter Setup

Transmit Preamble Character

Preamble characters (Country Code and System Character) can be transmitted as part of a UPC-A barcode. Select one of the following options for transmitting UPC-A preamble to the host device: transmit system character only, transmit system character and country code ("0" for USA), or transmit no preamble.



@UPAPRE0
**** No Preamble**



@UPAPRE1
System Character



@UPAPRE2
System Character & Country Code



@SETUPE0
**** Exit Setup**



@SETUPE1

Enter Setup

Coupon

UPC-A/EAN-13 with Extended Coupon Code

The following three types of coupon code + extended coupon code are supported:

1. UPC-A (starting with "5") + GS1-128
2. UPC-A (starting with "5") + GS1 Databar
3. EAN-13 (starting with "99") + GS1-128

Use the appropriate barcode below to enable or disable UPC-A/EAN-13 with Extended Coupon Code. When left on the default setting (**Off**), the scanner treats Coupon Codes and Extended Coupon Codes as single bar codes.

If you scan the **Allow Concatenation** code, when the scanner sees the coupon code and the extended coupon code in a single scan, it transmits both as separate symbologies. Otherwise, it transmits the first coupon code it reads.

If you scan the **Require Concatenation** code, the scanner must see and read the coupon code and extended coupon code in a single read to transmit the data. No data is output unless both codes are read.

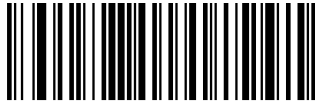

@CPNENA0

**** Off**



@CPNENA1

Allow Concatenation

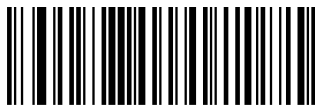

@CPNENA2

Require Concatenation



When using the UPC-A Coupon feature, please ensure that **System Character** or **System Character & Country Code** is selected for the "Transmit UPC-A Preamble Character" feature.



@SETUPE0

**** Exit Setup**



@SETUPE1
Enter Setup

Coupon GS1 Databar Output

If you scan coupons that have both UPC and GS1 Databar codes, you may wish to scan and output only the data from the GS1 Databar code. Scan the **GS1 Output On** barcode below to scan and output only the GS1 Databar code data.

When **GS1 Output Off** is selected, coupons that have both UPC and GS1 Databar codes are transmitted depending on your selection for the "UPC-A/EAN-13 with Extended Coupon Code" feature.



@CPNGS10
**** GS1 Output Off**



@CPNGS11
GS1 Output On



When using the UPC-A Coupon feature, please ensure that **System Character** or **System Character & Country Code** is selected for the "Transmit UPC-A Preamble Character" feature.



@SETUPE0
**** Exit Setup**



@SETUPE1
Enter Setup

Interleaved 2 of 5

Restore Factory Defaults



@I25DEF

Restore the Factory Defaults of Interleaved 2 of 5

Enable/Disable Interleaved 2 of 5



@I25ENA1

Enable Interleaved 2 of 5



@I25ENA0

**** Disable Interleaved 2 of 5**



If the scanner fails to identify Interleaved 2 of 5 barcodes, you may first try this solution by scanning the **Enter Setup** barcode and then **Enable Interleaved 2 of 5** barcode.



@SETUPE0
**** Exit Setup**



@SETUPE1
Enter Setup

Set Length Range for Interleaved 2 of 5

The scanner can be configured to only decode Interleaved 2 of 5 barcodes with lengths that fall between (inclusive) the minimum and maximum lengths. To accomplish it, you need to set the minimum and maximum lengths.



@I25MIN

Set the Minimum Length (Default: 6)



@I25MAX

Set the Maximum Length (Default: 80)



If minimum length is set to be greater than maximum length, the scanner only decodes Interleaved 2 of 5 barcodes with either the minimum or maximum length. If minimum length is same as maximum length, only Interleaved 2 of 5 barcodes with that length are to be decoded.



Set the scanner to decode Interleaved 2 of 5 barcodes containing between 8 and 12 characters:

1. Scan the **Enter Setup** barcode.
2. Scan the **Set the Minimum Length** barcode.
3. Scan the numeric barcode "8" from the "Digit Barcodes" section in Appendix.
4. Scan the **Save** barcode from the "Save/Cancel Barcodes" section in Appendix.
5. Scan the **Set the Maximum Length** barcode.
6. Scan the numeric barcodes "1" and "2" from the "Digit Barcodes" section in Appendix.
7. Scan the **Save** barcode from the "Save/Cancel Barcodes" section in Appendix.
8. Scan the **Exit Setup** barcode.



@SETUPE0
**** Exit Setup**



@SETUPE1
Enter Setup

Check Character Verification

A check character is optional for Interleaved 2 of 5 and can be added as the last character. It is a calculated value used to verify the integrity of the data.

Disable: The scanner transmits Interleaved 2 of 5 barcodes as is.

Do Not Transmit Check Character After Verification: The scanner checks the integrity of all Interleaved 2 of 5 barcodes to verify that the data complies with the check character algorithm. Barcodes passing the check will be transmitted except the last digit, whereas those failing it will not be transmitted.

Transmit Check Character After Verification: The scanner checks the integrity of all Interleaved 2 of 5 barcodes to verify that the data complies with the check character algorithm. Barcodes passing the check will be transmitted, whereas those failing it will not be transmitted.

Since Interleaved 2 of 5 must always have an even number of digits, a zero may need to be added as the first digit when the check character is added. The check character is automatically generated when making Interleaved 2 of 5 barcodes.



@I25CHK0
**** Disable**



@I25CHK1

Do Not Transmit Check Character After Verification



@I25CHK2

Transmit Check Character After Verification



If the **Do Not Transmit Check Character After Verification** option is enabled, Interleaved 2 of 5 barcodes with a length that is less than the configured minimum length after having the check character excluded will not be decoded. (For example, when the **Do Not Transmit Check Character After Verification** option is enabled and the minimum length is set to 4, Interleaved 2 of 5 barcodes with a total length of 4 characters including the check character cannot be read.)

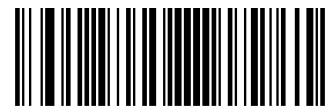

@SETUPE0
**** Exit Setup**



@SETUPE1
Enter Setup

ITF-14

ITF-14 is a special kind of Interleaved 2 of 5 with a length of 14 characters and the last character as the check character.

ITF-14 priority principle: For the Interleaved 2 of 5 barcodes with a length of 14 characters and the last character as the check character, the ITF-14 configurations shall take precedence over the Interleaved 2 of 5 settings.

Restore Factory Defaults



@I14DEF

Restore the Factory Defaults of ITF-14

Enable/Disable ITF-14



@I14ENA0

** Disable ITF-14



@I14ENA1

Enable ITF-14 But Do Not Transmit Check Character



@I14ENA2

Enable ITF-14 and Transmit Check Character



An example of the ITF-14 priority principle: when ITF-14 is enabled and Interleaved 2 of 5 is disabled, the scanner only decodes Interleaved 2 of 5 barcodes with a length of 14 characters and the last character as the check character.



@SETUPE0
** Exit Setup



@SETUPE1

Enter Setup



@SETUPE0

**** Exit Setup**



@SETUPE1
Enter Setup

ITF-6

ITF-6 is a special kind of Interleaved 2 of 5 with a length of 6 characters and the last character as the check character.

ITF-6 priority principle: For the Interleaved 2 of 5 barcodes with a length of 6 characters and the last character as the check character, the ITF-6 configurations shall take precedence over the Interleaved 2 of 5 settings.

Restore Factory Defaults



@IT6DEF

Restore the Factory Defaults of ITF-6

Enable/Disable ITF-6



@IT6ENA0

** Disable ITF-6



@IT6ENA1

Enable ITF-6 But Do Not Transmit Check Character



@IT6ENA2

Enable ITF-6 and Transmit Check Character



An example of the ITF-6 priority principle: when ITF-6 is enabled and Interleaved 2 of 5 is disabled, the scanner only decodes Interleaved 2 of 5 barcodes with a length of 6 characters and the last character as the check character.



@SETUPE0
** Exit Setup



@SETUPE1
Enter Setup

Matrix 2 of 5

Restore Factory Defaults



@M25DEF

Restore the Factory Defaults of Matrix 2 of 5

Enable/Disable Matrix 2 of 5



@M25ENA1

Enable Matrix 2 of 5



@M25ENA0

**** Disable Matrix 2 of 5**



If the scanner fails to identify Matrix 2 of 5 barcodes, you may first try this solution by scanning the **Enter Setup** barcode and then **Enable Matrix 2 of 5** barcode.

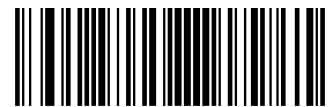

@SETUPE0
**** Exit Setup**



@SETUPE1
Enter Setup

Set Length Range for Matrix 2 of 5

The scanner can be configured to only decode Matrix 2 of 5 barcodes with lengths that fall between (inclusive) the minimum and maximum lengths. To accomplish it, you need to set the minimum and maximum lengths.



@M25MIN

Set the Minimum Length (Default: 4)



@M25MAX

Set the Maximum Length (Default: 80)



If minimum length is set to be greater than maximum length, the scanner only decodes Matrix 2 of 5 barcodes with either the minimum or maximum length. If minimum length is same as maximum length, only Matrix 2 of 5 barcodes with that length are to be decoded.



Set the scanner to decode Matrix 2 of 5 barcodes containing between 8 and 12 characters:

1. Scan the **Enter Setup** barcode.
2. Scan the **Set the Minimum Length** barcode.
3. Scan the numeric barcode "8" from the "Digit Barcodes" section in Appendix.
4. Scan the **Save** barcode from the "Save/Cancel Barcodes" section in Appendix.
5. Scan the **Set the Maximum Length** barcode.
6. Scan the numeric barcodes "1" and "2" from the "Digit Barcodes" section in Appendix.
7. Scan the **Save** barcode from the "Save/Cancel Barcodes" section in Appendix.
8. Scan the **Exit Setup** barcode.



@SETUPE0
**** Exit Setup**



@SETUPE1

Enter Setup

Check Character Verification

A check character is optional for Matrix 2 of 5 and can be added as the last character. It is a calculated value used to verify the integrity of the data.

Disable: The scanner transmits Matrix 2 of 5 barcodes as is.

Do Not Transmit Check Character After Verification: The scanner checks the integrity of all Matrix 2 of 5 barcodes to verify that the data complies with the check character algorithm. Barcodes passing the check will be transmitted except the last digit, whereas those failing it will not be transmitted.

Transmit Check Character After Verification: The scanner checks the integrity of all Matrix 2 of 5 barcodes to verify that the data complies with the check character algorithm. Barcodes passing the check will be transmitted, whereas those failing it will not be transmitted.

Since Matrix 2 of 5 must always have an even number of digits, a zero may need to be added as the first digit when the check character is added. The check character is automatically generated when making Matrix 2 of 5 barcodes.



@M25CHK0

** Disable

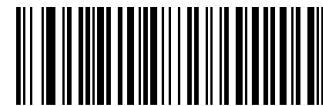

@M25CHK1

Do Not Transmit Check Character After Verification



@M25CHK2

Transmit Check Character After Verification



If the **Do Not Transmit Check Character After Verification** option is enabled, Matrix 2 of 5 barcodes with a length that is less than the configured minimum length after having the check character excluded will not be decoded. (For example, when the **Do Not Transmit Check Character After Verification** option is enabled and the minimum length is set to 4, Matrix 2 of 5 barcodes with a total length of 4 characters including the check character cannot be read.)



@SETUPE0

** Exit Setup



@SETUPE1
Enter Setup

Code 39

Restore Factory Defaults



@C39DEF
Restore the Factory Defaults of Code 39

Enable/Disable Code 39



@C39ENA1
** Enable Code 39



@C39ENA0
Disable Code 39



If the scanner fails to identify Code 39 barcodes, you may first try this solution by scanning the **Enter Setup** barcode and then **Enable Code 39** barcode.



@SETUPE0
** Exit Setup



@SETUPE1
Enter Setup

Set Length Range for Code 39

The scanner can be configured to only decode Code 39 barcodes with lengths that fall between (inclusive) the minimum and maximum lengths. To accomplish it, you need to set the minimum and maximum lengths.



@C39MIN

Set the Minimum Length (Default: 1)



@C39MAX

Set the Maximum Length (Default: 48)



If minimum length is set to be greater than maximum length, the scanner only decodes Code 39 barcodes with either the minimum or maximum length. If minimum length is same as maximum length, only Code 39 barcodes with that length are to be decoded.



Set the scanner to decode Code 39 barcodes containing between 8 and 12 characters:

1. Scan the **Enter Setup** barcode.
2. Scan the **Set the Minimum Length** barcode.
3. Scan the numeric barcode "8" from the "Digit Barcodes" section in Appendix.
4. Scan the **Save** barcode from the "Save/Cancel Barcodes" section in Appendix.
5. Scan the **Set the Maximum Length** barcode.
6. Scan the numeric barcodes "1" and "2" from the "Digit Barcodes" section in Appendix.
7. Scan the **Save** barcode from the "Save/Cancel Barcodes" section in Appendix.
8. Scan the **Exit Setup** barcode.



@SETUPE0
**** Exit Setup**



@SETUPE1
Enter Setup

Check Character Verification

A check character is optional for Code 39 and can be added as the last character. It is a calculated value used to verify the integrity of the data.

Disable: The scanner transmits Code 39 barcodes as is.

Do Not Transmit Check Character After Verification: The scanner checks the integrity of all Code 39 barcodes to verify that the data complies with the check character algorithm. Barcodes passing the check will be transmitted except the last digit, whereas those failing it will not be transmitted.

Transmit Check Character After Verification: The scanner checks the integrity of all Code 39 barcodes to verify that the data complies with the check character algorithm. Barcodes passing the check will be transmitted, whereas those failing it will not be transmitted.



@C39CHK0
** Disable



@C39CHK1
Do Not Transmit Check Character After Verification



@C39CHK2
Transmit Check Character After Verification



If the **Do Not Transmit Check Character After Verification** option is enabled, Code 39 barcodes with a length that is less than the configured minimum length after having the check character excluded will not be decoded. (For example, when the **Do Not Transmit Check Character After Verification** option is enabled and the minimum length is set to 4, Code 39 barcodes with a total length of 4 characters including the check character cannot be read.)



@SETUPE0
** Exit Setup



@SETUPE1
Enter Setup

Transmit Start/Stop Character

Code 39 uses an asterisk (*) for both the start and the stop characters. You can choose whether or not to transmit the start/stop characters by scanning the appropriate barcode below.



@C39TSC0

**** Do Not Transmit Start/Stop Character**



@C39TSC1

Transmit Start/Stop Character

Enable/Disable Code 39 Full ASCII

The scanner can be configured to identify all ASCII characters by scanning the appropriate barcode below.



@C39ASC0

**** Disable Code 39 Full ASCII**



@C39ASC1

Enable Code 39 Full ASCII

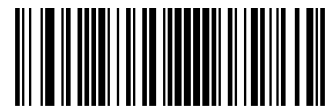

@SETUPE0
**** Exit Setup**



@SETUPE1
Enter Setup

Enable/Disable Code 32 (Italian Pharma Code)

Code 32 is a variant of Code 39 used by the Italian pharmaceutical industry. Scan the appropriate bar code below to enable or disable Code 32. Code 39 must be enabled and Code 39 check character verification must be disabled for this parameter to function.



@C39E320
**** Disable Code 32**



@C39E321
Enable Code 32

Code 32 Prefix

Scan the appropriate barcode below to enable or disable adding the prefix character "A" to all Code 32 barcodes. Code 32 must be enabled for this parameter to function.



@C39S320
**** Disable Code 32 Prefix**



@C39S321
Enable Code 32 Prefix



@SETUPE0
**** Exit Setup**



@SETUPE1
Enter Setup

Transmit Code 32 Start/Stop Character

Code 32 must be enabled for this parameter to function.



@C39T320

**** Do Not Transmit Code 32 Start/Stop Character**



@C39T321

Transmit Code 32 Start/Stop Character

Transmit Code 32 Check Character

Code 32 must be enabled for this parameter to function.



@C39C320

**** Do Not Transmit Code 32 Check Character**



@C39C321

Transmit Code 32 Check Character

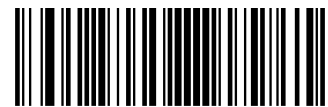

@SETUPE0
**** Exit Setup**



@SETUPE1
Enter Setup

Codabar

Restore Factory Defaults



@CBADEF
Restore the Factory Defaults of Codabar

Enable/Disable Codabar



@CBAENA1
Enable Codabar



**** Disable Codabar**



If the scanner fails to identify Codabar barcodes, you may first try this solution by scanning the **Enter Setup** barcode and then **Enable Codabar** barcode.



@SETUPE0
**** Exit Setup**



@SETUPE1
Enter Setup

Set Length Range for Codabar

The scanner can be configured to only decode Codabar barcodes with lengths that fall between (inclusive) the minimum and maximum lengths. To accomplish it, you need to set the minimum and maximum lengths.



Set the Minimum Length (Default: 2)



Set the Maximum Length (Default: 60)



If minimum length is set to be greater than maximum length, the scanner only decodes Codabar barcodes with either the minimum or maximum length. If minimum length is same as maximum length, only Codabar barcodes with that length are to be decoded.



Set the scanner to decode Codabar barcodes containing between 8 and 12 characters:

1. Scan the **Enter Setup** barcode.
2. Scan the **Set the Minimum Length** barcode.
3. Scan the numeric barcode “8” from the “Digit Barcodes” section in Appendix.
4. Scan the **Save** barcode from the “Save/Cancel Barcodes” section in Appendix.
5. Scan the **Set the Maximum Length** barcode.
6. Scan the numeric barcodes “1” and “2” from the “Digit Barcodes” section in Appendix.
7. Scan the **Save** barcode from the “Save/Cancel Barcodes” section in Appendix.
8. Scan the **Exit Setup** barcode.



@SETUPE0
**** Exit Setup**



@SETUPE1
Enter Setup

Check Character Verification

A check character is optional for Codabar and can be added as the last character. It is a calculated value used to verify the integrity of the data.

Disable: The scanner transmits Codabar barcodes as is.

Do Not Transmit Check Character After Verification: The scanner checks the integrity of all Codabar barcodes to verify that the data complies with the check character algorithm. Barcodes passing the check will be transmitted except the last digit, whereas those failing it will not be transmitted.

Transmit Check Character After Verification: The scanner checks the integrity of all Codabar barcodes to verify that the data complies with the check character algorithm. Barcodes passing the check will be transmitted, whereas those failing it will not be transmitted.



@CBACHK0
**** Disable**



@CBACHK1

Do Not Transmit Check Character After Verification

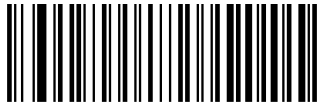

@CBACHK2

Transmit Check Character After Verification



If the **Do Not Transmit Check Character After Verification** option is enabled, Codabar barcodes with a length that is less than the configured minimum length after having the check character excluded will not be decoded. (For example, when the **Do Not Transmit Check Character After Verification** option is enabled and the minimum length is set to 4, Codabar barcodes with a total length of 4 characters including the check character cannot be read.)



@SETUPE0
**** Exit Setup**



@SETUPE1
Enter Setup

Start/Stop Character

You can set the start/stop characters and choose whether or not to transmit the start/stop characters by scanning the appropriate barcode below.



@CBATSC0

**** Do Not Transmit Start/Stop Character**



@CBATSC1

Transmit Start/Stop Character



@CBASCF0

**** ABCD/ABCD as the Start/Stop Character**



@CBASCF1

ABCD/TN*E as the Start/Stop Character



@CBASCF2

abcd/abcd as the Start/Stop Character



@CBASCF3

abcd/tn*e as the Start/Stop Character

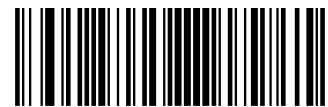

@SETUPE0
**** Exit Setup**



@SETUPE1
Enter Setup

Code 93

Restore Factory Defaults



@C93DEF
Restore the Factory Defaults of Code 93

Enable/Disable Code 93



@C93ENA1
Enable Code 93



@C93ENA0
**** Disable Code 93**



If the scanner fails to identify Code 93 barcodes, you may first try this solution by scanning the **Enter Setup** barcode and then **Enable Code 93** barcode.



@SETUPE0
**** Exit Setup**



@SETUPE1
Enter Setup

Set Length Range for Code 93

The scanner can be configured to only decode Code 93 barcodes with lengths that fall between (inclusive) the minimum and maximum lengths. To accomplish it, you need to set the minimum and maximum lengths.



@C93MIN

Set the Minimum Length (Default: 1)



@C93MAX

Set the Maximum Length (Default: 48)



If minimum length is set to be greater than maximum length, the scanner only decodes Code 93 barcodes with either the minimum or maximum length. If minimum length is same as maximum length, only Code 93 barcodes with that length are to be decoded.



Set the scanner to decode Code 93 barcodes containing between 8 and 12 characters:

1. Scan the **Enter Setup** barcode.
2. Scan the **Set the Minimum Length** barcode.
3. Scan the numeric barcode “8” from the “Digit Barcodes” section in Appendix.
4. Scan the **Save** barcode from the “Save/Cancel Barcodes” section in Appendix.
5. Scan the **Set the Maximum Length** barcode.
6. Scan the numeric barcodes “1” and “2” from the “Digit Barcodes” section in Appendix.
7. Scan the **Save** barcode from the “Save/Cancel Barcodes” section in Appendix.
8. Scan the **Exit Setup** barcode.



@SETUPE0
**** Exit Setup**



@SETUPE1
Enter Setup

Check Character Verification

Check characters are optional for Code 93 and can be added as the last two characters, which are calculated values used to verify the integrity of the data.

Disable: The scanner transmits Code 93 barcodes as is.

Do Not Transmit Check Character After Verification: The scanner checks the integrity of all Code 93 barcodes to verify that the data complies with the check character algorithm. Barcodes passing the checks will be transmitted except the last two digits, whereas those failing them will not be transmitted.

Transmit Check Character After Verification: The scanner checks the integrity of all Code 93 barcodes to verify that the data complies with the check character algorithm. Barcodes passing the checks will be transmitted, whereas those failing them will not be transmitted.



@C93CHK0
Disable

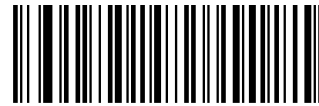

@C93CHK1

**** Do Not Transmit Check Character After Verification**



@C93CHK2

Transmit Check Character After Verification



If the **Do Not Transmit Check Character After Verification** option is enabled, Code 93 barcodes with a length that is less than the configured minimum length after having the two check characters excluded will not be decoded. (For example, when the **Do Not Transmit Check Character After Verification** option is enabled and the minimum length is set to 4, Code 93 barcodes with a total length of 4 characters including the two check characters cannot be read.)



@SETUPE0
**** Exit Setup**



@SETUPE1
Enter Setup

China Post 25

Restore Factory Defaults

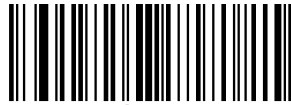

@CHPDEF

Restore the Factory Defaults of China Post 25

Enable/Disable China Post 25



@CHPEN A1

Enable China Post 25



@CHPEN A0

**** Disable China Post 25**



If the scanner fails to identify China Post 25 barcodes, you may first try this solution by scanning the **Enter Setup** barcode and then **Enable China Post 25** barcode.

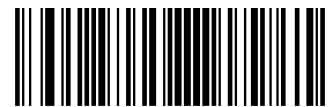

@SETUPE0
**** Exit Setup**



@SETUPE1
Enter Setup

Set Length Range for China Post 25

The scanner can be configured to only decode China Post 25 barcodes with lengths that fall between (inclusive) the minimum and maximum lengths. To accomplish it, you need to set the minimum and maximum lengths.



@CHPMIN

Set the Minimum Length (Default: 1)



@CHPMAX

Set the Maximum Length (Default: 48)



If minimum length is set to be greater than maximum length, the scanner only decodes China Post 25 barcodes with either the minimum or maximum length. If minimum length is same as maximum length, only China Post 25 barcodes with that length are to be decoded.



Set the scanner to decode China Post 25 barcodes containing between 8 and 12 characters:

1. Scan the **Enter Setup** barcode.
2. Scan the **Set the Minimum Length** barcode.
3. Scan the numeric barcode “8” from the “Digit Barcodes” section in Appendix.
4. Scan the **Save** barcode from the “Save/Cancel Barcodes” section in Appendix.
5. Scan the **Set the Maximum Length** barcode.
6. Scan the numeric barcodes “1” and “2” from the “Digit Barcodes” section in Appendix.
7. Scan the **Save** barcode from the “Save/Cancel Barcodes” section in Appendix.
8. Scan the **Exit Setup** barcode.



@SETUPE0
**** Exit Setup**



@SETUPE1
Enter Setup

Check Character Verification

A check character is optional for China Post 25 and can be added as the last character. It is a calculated value used to verify the integrity of the data.

Disable: The scanner transmits China Post 25 barcodes as is.

Do Not Transmit Check Character After Verification: The scanner checks the integrity of all China Post 25 barcodes to verify that the data complies with the check character algorithm. Barcodes passing the check will be transmitted except the last digit, whereas those failing it will not be transmitted.

Transmit Check Character After Verification: The scanner checks the integrity of all China Post 25 barcodes to verify that the data complies with the check character algorithm. Barcodes passing the check will be transmitted, whereas those failing it will not be transmitted.



@CHPCHK0
** Disable



@CHPCHK1

Do Not Transmit Check Character After Verification



@CHPCHK2

Transmit Check Character After Verification



If the **Do Not Transmit Check Character After Verification** option is enabled, China Post 25 barcodes with a length that is less than the configured minimum length after having the check character excluded will not be decoded. (For example, when the **Do Not Transmit Check Character After Verification** option is enabled and the minimum length is set to 4, China Post 25 barcodes with a total length of 4 characters including the check character cannot be read.)



@SETUPE0
** Exit Setup



@SETUPE1
Enter Setup

GS1-128 (UCC/EAN-128)

Restore Factory Defaults



@GS1DEF

Restore the Factory Defaults of GS1-128

Enable/Disable GS1-128



@GS1ENA1

** Enable GS1-128



@GS1ENA0

Disable GS1-128



If the scanner fails to identify GS1-128 barcodes, you may first try this solution by scanning the **EnterSetup** barcode and then **Enable GS1-128** barcode.



@SETUPE0
** Exit Setup



@SETUPE1
Enter Setup

Set Length Range for GS1-128

The scanner can be configured to only decode GS1-128 barcodes with lengths that fall between (inclusive) the minimum and maximum lengths. To accomplish it, you need to set the minimum and maximum lengths.



@GS1MIN

Set the Minimum Length (Default: 1)



@GS1MAX

Set the Maximum Length (Default: 48)



If minimum length is set to be greater than maximum length, the scanner only decodes GS1-128 barcodes with either the minimum or maximum length. If minimum length is same as maximum length, only GS1-128 barcodes with that length are to be decoded.



Set the scanner to decode GS1-128 barcodes containing between 8 and 12 characters:

1. Scan the **Enter Setup** barcode.
2. Scan the **Set the Minimum Length** barcode.
3. Scan the numeric barcode "8" from the "Digit Barcodes" section in Appendix.
4. Scan the **Save** barcode from the "Save/Cancel Barcodes" section in Appendix.
5. Scan the **Set the Maximum Length** barcode.
6. Scan the numeric barcodes "1" and "2" from the "Digit Barcodes" section in Appendix.
7. Scan the **Save** barcode from the "Save/Cancel Barcodes" section in Appendix.
8. Scan the **Exit Setup** barcode.



@SETUPE0
**** Exit Setup**



@SETUPE1
Enter Setup

GS1 Databar (RSS)

Restore Factory Defaults



@RSSDEF
Restore the Factory Defaults of GS1 Databar

Enable/Disable GS1 Databar



@RSSENA1
Enable GS1 Databar



@RSSENA0
** Disable GS1 Databar



If the scanner fails to identify GS1 Databar barcodes, you may first try this solution by scanning the **Enter Setup** barcode and then **Enable GS1 Databar** barcode.

Transmit Application Identifier "01"



@RSSTA1
** Transmit Application Identifier "01"



@SETUPE0
** Exit Setup



@SETUPE1

Enter Setup



@RSSTAI0

Do Not Transmit Application Identifier "01"

GS1 Composite (EAN-UCC Composite)

Restore Factory Defaults



@CPTDEF

Restore the Factory Defaults of GS1 Composite

Enable/Disable GS1 Composite



@CPTENA1

Enable GS1 Composite



@CPTENA0

**** Disable GS1 Composite**



If the scanner fails to identify GS1 Composite barcodes, you may first try this solution by scanning the **Enter Setup** barcode and then **Enable GS1 Composite** barcode.

Enable/Disable UPC/EAN Composite



@CPTUPC1

Enable UPC/EAN Composite



@SETUPE0

**** Exit Setup**



@SETUPE1
Enter Setup



@CPTUPC0
** Disable UPC/EAN Composite

Code 11

Restore Factory Defaults



@C11DEF
Restore the Factory Defaults of Code 11

Enable/Disable Code 11



@C11ENA1
Enable Code 11



@C11ENA0
** Disable Code 11



If the scanner fails to identify Code 11 barcodes, you may first try this solution by scanning the **Enter Setup** barcode and then **Enable Code 11** barcode.



@SETUPE0
** Exit Setup



@SETUPE1

Enter Setup

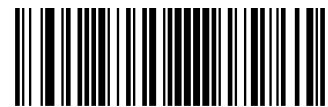

@SETUPE0

**** Exit Setup**



@SETUPE1
Enter Setup

Set Length Range for Code 11

The scanner can be configured to only decode Code 11 barcodes with lengths that fall between (inclusive) the minimum and maximum lengths. To accomplish it, you need to set the minimum and maximum lengths.



@C11MIN

Set the Minimum Length (Default: 4)



@C11MAX

Set the Maximum Length (Default: 48)



If minimum length is set to be greater than maximum length, the scanner only decodes Code 11 barcodes with either the minimum or maximum length. If minimum length is same as maximum length, only Code 11 barcodes with that length are to be decoded.



Set the scanner to decode Code 11 barcodes containing between 8 and 12 characters:

1. Scan the **Enter Setup** barcode.
2. Scan the **Set the Minimum Length** barcode.
3. Scan the numeric barcode "8" from the "Digit Barcodes" section in Appendix.
4. Scan the **Save** barcode from the "Save/Cancel Barcodes" section in Appendix.
5. Scan the **Set the Maximum Length** barcode.
6. Scan the numeric barcodes "1" and "2" from the "Digit Barcodes" section in Appendix.
7. Scan the **Save** barcode from the "Save/Cancel Barcodes" section in Appendix.
8. Scan the **Exit Setup** barcode.



@SETUPE0
**** Exit Setup**



@SETUPE1
Enter Setup

Check Character Verification

Check characters are optional for Code 11 and can be added as the last one or two characters, which are calculated values used to verify the integrity of the data.

If the **Disable** option is enabled, the scanner transmits Code 11 barcodes as is.



@C11CHK0
Disable



@C11CHK1
** One Check Character, MOD11



@C11CHK2
Two Check Characters, MOD11/MOD11



@C11CHK3
Two Check Characters, MOD11/MOD9



@C11CHK4
One Check Character, MOD11 (Len<=10)
Two Check Characters, MOD11/MOD11(Len>10)



@C11CHK5
One Check Character, MOD11 (Len<=10)
Two Check Characters, MOD11/MOD9 (Len>10)



@SETUPE0
** Exit Setup



@SETUPE1
Enter Setup

Transmit Check Character



@C11TCK0

Do Not Transmit Code 11 Check Character



@C11TCK1

** Transmit Code 11 Check Character



If you select a check character algorithm and the **Do Not Transmit Check Character** option, Code 11 barcodes with a length that is less than the configured minimum length after having the check character(s) excluded will not be decoded. (For example, when the **One Check Character, MOD11** and **Do Not Transmit Check Character** options are enabled and the minimum length is set to 4, Code 11 barcodes with a total length of 4 characters including the check character cannot be read.)



@SETUPE0
** Exit Setup



@SETUPE1
Enter Setup

ISBN

Restore Factory Defaults

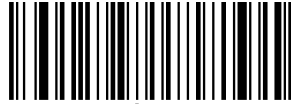

@ISBDEF

Restore the Factory Defaults of ISBN

Enable/Disable ISBN

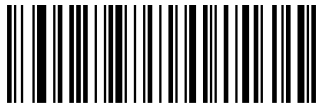

@ISBENA1

**** Enable ISBN**



@ISBENA0

Disable ISBN



If the scanner fails to identify ISBN barcodes, you may first try this solution by scanning the **Enter Setup** barcode and then **Enable ISBN** barcode.

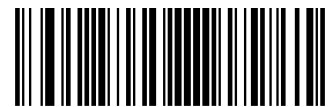

@SETUPE0
**** Exit Setup**



@SETUPE1
Enter Setup

Set ISBN Format



@ISBT101
** ISBN-10



@ISBT100
ISBN-13



@SETUPE0
** Exit Setup



@SETUPE1
Enter Setup

ISSN

Restore Factory Defaults



@ISSDEF

Restore the Factory Defaults of ISSN

Enable/Disable ISSN



@ISSENA1

**** Enable ISSN**



@ISSENA0

Disable ISSN



If the scanner fails to identify ISSN barcodes, you may first try this solution by scanning the **Enter Setup** barcode and then **Enable ISSN** barcode.

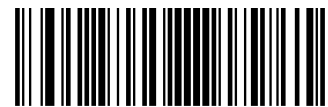

@SETUPE0
**** Exit Setup**



@SETUPE1
Enter Setup

Industrial 25

Restore Factory Defaults



@L25DEF
Restore the Factory Defaults of Industrial 25

Enable/Disable Industrial 25



@L25ENA1
Enable Industrial 25



@L25ENA0
** Disable Industrial 25



If the scanner fails to identify Industrial 25 barcodes, you may first try this solution by scanning the **Enter Setup** barcode and then **Enable Industrial 25** barcode.



@SETUPE0
** Exit Setup



@SETUPE1
Enter Setup

Set Length Range for Industrial 25

The scanner can be configured to only decode Industrial 25 barcodes with lengths that fall between (inclusive) the minimum and maximum lengths. To accomplish it, you need to set the minimum and maximum lengths.



@L25MIN

Set the Minimum Length (Default: 6)



@L25MAX

Set the Maximum Length (Default: 48)



If minimum length is set to be greater than maximum length, the scanner only decodes Industrial 25 barcodes with either the minimum or maximum length. If minimum length is same as maximum length, only Industrial 25 barcodes with that length are to be decoded.



Set the scanner to decode Industrial 25 barcodes containing between 8 and 12 characters:

1. Scan the **Enter Setup** barcode.
2. Scan the **Set the Minimum Length** barcode.
3. Scan the numeric barcode “8” from the “Digit Barcodes” section in Appendix.
4. Scan the **Save** barcode from the “Save/Cancel Barcodes” section in Appendix.
5. Scan the **Set the Maximum Length** barcode.
6. Scan the numeric barcodes “1” and “2” from the “Digit Barcodes” section in Appendix.
7. Scan the **Save** barcode from the “Save/Cancel Barcodes” section in Appendix.
8. Scan the **Exit Setup** barcode.

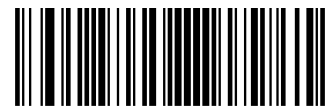

@SETUPE0
**** Exit Setup**



@SETUPE1
Enter Setup

Check Character Verification

A check character is optional for Industrial 25 and can be added as the last character. It is a calculated value used to verify the integrity of the data.

Disable: The scanner transmits Industrial 25 barcodes as is.

Do Not Transmit Check Character After Verification: The scanner checks the integrity of all Industrial 25 barcodes to verify that the data complies with the check character algorithm. Barcodes passing the check will be transmitted except the last digit, whereas those failing it will not be transmitted.

Transmit Check Character After Verification: The scanner checks the integrity of all Industrial 25 barcodes to verify that the data complies with the check character algorithm. Barcodes passing the check will be transmitted, whereas those failing it will not be transmitted.



@L25CHK0
** Disable



Do Not Transmit Check Character After Verification

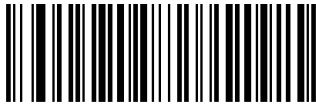

Transmit Check Character After Verification



If the **Do Not Transmit Check Character After Verification** option is enabled, Industrial 25 barcodes with a length that is less than the configured minimum length after having the check character excluded will not be decoded. (For example, when the **Do Not Transmit Check Character After Verification** option is enabled and the minimum length is set to 4, Industrial 25 barcodes with a total length of 4 characters including the check character cannot be read.)



@SETUPE0
** Exit Setup



@SETUPE1
Enter Setup

Standard 25

Restore Factory Defaults



@S25DEF

Restore the Factory Defaults of Standard 25

Enable/Disable Standard 25



@S25ENA1

Enable Standard 25



@S25ENA0

**** Disable Standard 25**



If the scanner fails to identify Standard 25 barcodes, you may first try this solution by scanning the **Enter Setup** barcode and then **Enable Standard 25** barcode.



@SETUPE0
**** Exit Setup**



@SETUPE1
Enter Setup

Set Length Range for Standard 25

The scanner can be configured to only decode Standard 25 barcodes with lengths that fall between (inclusive) the minimum and maximum lengths. To accomplish it, you need to set the minimum and maximum lengths.



@S25MIN

Set the Minimum Length (Default: 6)



@S25MAX

Set the Maximum Length (Default: 48)



If minimum length is set to be greater than maximum length, the scanner only decodes Standard 25 barcodes with either the minimum or maximum length. If minimum length is same as maximum length, only Standard 25 barcodes with that length are to be decoded.

E
xample

Set the scanner to decode Standard 25 barcodes containing between 8 and 12 characters:

1. Scan the **Enter Setup** barcode.
2. Scan the **Set the Minimum Length** barcode.
3. Scan the numeric barcode "8" from the "Digit Barcodes" section in Appendix.
4. Scan the **Save** barcode from the "Save/Cancel Barcodes" section in Appendix.
5. Scan the **Set the Maximum Length** barcode.
6. Scan the numeric barcodes "1" and "2" from the "Digit Barcodes" section in Appendix.
7. Scan the **Save** barcode from the "Save/Cancel Barcodes" section in Appendix.
8. Scan the **Exit Setup** barcode.



@SETUPE0
**** Exit Setup**



@SETUPE1
Enter Setup

Check Character Verification

A check character is optional for Standard 25 and can be added as the last character. It is a calculated value used to verify the integrity of the data.

Disable: The scanner transmits Standard 25 barcodes as is.

Do Not Transmit Check Character After Verification: The scanner checks the integrity of all Standard 25 barcodes to verify that the data complies with the check character algorithm. Barcodes passing the check will be transmitted except the last digit, whereas those failing it will not be transmitted.

Transmit Check Character After Verification: The scanner checks the integrity of all Standard 25 barcodes to verify that the data complies with the check character algorithm. Barcodes passing the check will be transmitted, whereas those failing it will not be transmitted.



@S25CHK0
** Disable



@S25CHK1

Do Not Transmit Check Character After Verification



@S25CHK2

Transmit Check Character After Verification



If the **Do Not Transmit Check Character After Verification** option is enabled, Standard 25 barcodes with a length that is less than the configured minimum length after having the check character excluded will not be decoded. (For example, when the **Do Not Transmit Check Character After Verification** option is enabled and the minimum length is set to 4, Standard 25 barcodes with a total length of 4 characters including the check character cannot be read.)

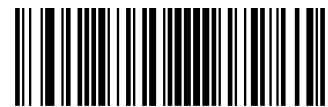

@SETUPE0
** Exit Setup



@SETUPE1
Enter Setup

Plessey

Restore Factory Defaults



@PLYDEF
Restore the Factory Defaults of Plessey

Enable/Disable Plessey



@PLYENA1
Enable Plessey



@PLYENA0
** Disable Plessey



If the scanner fails to identify Plessey barcodes, you may first try this solution by scanning the **Enter Setup** barcode and then **Enable Plessey** barcode.



@SETUPE0
** Exit Setup



@SETUPE1
Enter Setup

Set Length Range for Plessey

The scanner can be configured to only decode Plessey barcodes with lengths that fall between (inclusive) the minimum and maximum lengths. To accomplish it, you need to set the minimum and maximum lengths.



Set the Minimum Length (Default: 4)



Set the Maximum Length (Default: 48)



If minimum length is set to be greater than maximum length, the scanner only decodes Plessey barcodes with either the minimum or maximum length. If minimum length is same as maximum length, only Plessey barcodes with that length are to be decoded.



Set the scanner to decode Plessey barcodes containing between 8 and 12 characters:

1. Scan the **Enter Setup** barcode.
2. Scan the **Set the Minimum Length** barcode.
3. Scan the numeric barcode “8” from the “Digit Barcodes” section in Appendix.
4. Scan the **Save** barcode from the “Save/Cancel Barcodes” section in Appendix.
5. Scan the **Set the Maximum Length** barcode.
6. Scan the numeric barcodes “1” and “2” from the “Digit Barcodes” section in Appendix.
7. Scan the **Save** barcode from the “Save/Cancel Barcodes” section in Appendix.
8. Scan the **Exit Setup** barcode.

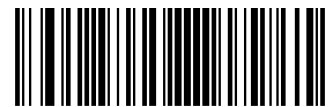

@SETUPE0
**** Exit Setup**



@SETUPE1
Enter Setup

Check Character Verification

Check characters are optional for Plessey and can be added as the last two characters, which are calculated values used to verify the integrity of the data.

Disable: The scanner transmits Plessey barcodes as is.

Do Not Transmit Check Character After Verification: The scanner checks the integrity of all Plessey barcodes to verify that the data complies with the check character algorithm. Barcodes passing the checks will be transmitted except the last two digits, whereas those failing them will not be transmitted.

Transmit Check Character After Verification: The scanner checks the integrity of all Plessey barcodes to verify that the data complies with the check character algorithm. Barcodes passing the checks will be transmitted, whereas those failing them will not be transmitted.



@PLYCHK0
** Disable

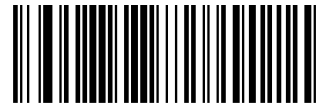

@PLYCHK1

Do Not Transmit Check Character After Verification



@PLYCHK2

Transmit Check Character After Verification



If the **Do Not Transmit Check Character After Verification** option is enabled, Plessey barcodes with a length that is less than the configured minimum length after having the check characters excluded will not be decoded. (For example, when the **Do Not Transmit Check Character After Verification** option is enabled and the minimum length is set to 4, Plessey barcodes with a total length of 4 characters including the check characters cannot be read.)



@SETUPE0
** Exit Setup



@SETUPE1
Enter Setup

MSI-Plessey

Restore Factory Defaults



@MSIDF

Restore the Factory Defaults of MSI-Plessey

Enable/Disable MSI-Plessey



@MSIENA1

Enable MSI-Plessey



@MSIENA0

**** Disable MSI-Plessey**



If the scanner fails to identify MSI-Plessey barcodes, you may first try this solution by scanning the **Enter Setup** barcode and then **Enable MSI-Plessey** barcode.



@SETUPE0
**** Exit Setup**



@SETUPE1
Enter Setup

Set Length Range for MSI-Plessey

The scanner can be configured to only decode MSI-Plessey barcodes with lengths that fall between (inclusive) the minimum and maximum lengths. To accomplish it, you need to set the minimum and maximum lengths.



@MSIMIN

Set the Minimum Length (Default: 4)



@MSIMAX

Set the Maximum Length (Default: 48)



If minimum length is set to be greater than maximum length, the scanner only decodes MSI-Plessey barcodes with either the minimum or maximum length. If minimum length is same as maximum length, only MSI-Plessey barcodes with that length are to be decoded.



Set the scanner to decode MSI-Plessey barcodes containing between 8 and 12 characters:

1. Scan the **Enter Setup** barcode.
2. Scan the **Set the Minimum Length** barcode.
3. Scan the numeric barcode “8” from the “Digit Barcodes” section in Appendix.
4. Scan the **Save** barcode from the “Save/Cancel Barcodes” section in Appendix.
5. Scan the **Set the Maximum Length** barcode.
6. Scan the numeric barcodes “1” and “2” from the “Digit Barcodes” section in Appendix.
7. Scan the **Save** barcode from the “Save/Cancel Barcodes” section in Appendix.
8. Scan the **Exit Setup** barcode.



@SETUPE0
**** Exit Setup**



@SETUPE1
Enter Setup

Check Character Verification

Check characters are optional for MSI-Plessey and can be added as the last one or two characters, which are calculated values used to verify the integrity of the data.

If the **Disable** option is enabled, the scanner transmits MSI-Plessey barcodes as is.

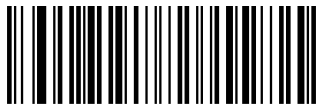

@MSICLK0
Disable



@MSICLK1
**** One Check Character, MOD10**

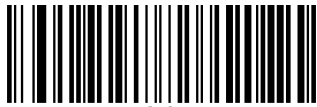

@MSICLK2
Two Check Characters, MOD10/MOD10



@MSICLK3
Two Check Characters, MOD10/MOD11



@SETUPE0
**** Exit Setup**



@SETUPE1
Enter Setup

Transmit Check Character



@MSITCK1

** Transmit MSI-Plessey Check Character



@MSITCK0

Do Not Transmit MSI-Plessey Check Character



If you select a check character algorithm and the **Do Not Transmit Check Character** option, MSI-Plessey barcodes with a length that is less than the configured minimum length after having the check character(s) excluded will not be decoded. (For example, when the **One Check Character, MOD10** and **Do Not Transmit Check Character** options are enabled and the minimum length is set to 4, MSI-Plessey barcodes with a total length of 4 characters including the check character cannot be read.)



@SETUPE0
** Exit Setup



@SETUPE1
Enter Setup

AIM 128

Restore Factory Defaults



@AIMDEF
Restore the Factory Defaults of AIM 128

Enable/Disable AIM 128



@AIMENA1
**** Enable AIM 128**



@AIMENA0
Disable AIM 128



If the scanner fails to identify AIM 128 barcodes, you may first try this solution by scanning the **Enter Setup** barcode and then **Enable AIM 128** barcode.



@SETUPE0
**** Exit Setup**



@SETUPE1
Enter Setup

Set Length Range for AIM 128

The scanner can be configured to only decode AIM 128 barcodes with lengths that fall between (inclusive) the minimum and maximum lengths. To accomplish it, you need to set the minimum and maximum lengths.

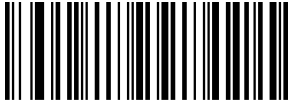

@AIMMIN

Set the Minimum Length (Default: 1)

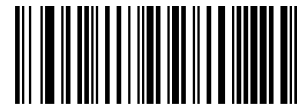

@AIMMAX

Set the Maximum Length (Default: 48)



If minimum length is set to be greater than maximum length, the scanner only decodes AIM 128 barcodes with either the minimum or maximum length. If minimum length is same as maximum length, only AIM 128 barcodes with that length are to be decoded.



Set the scanner to decode AIM 128 barcodes containing between 8 and 12 characters:

1. Scan the **Enter Setup** barcode.
2. Scan the **Set the Minimum Length** barcode.
3. Scan the numeric barcode "8" from the "Digit Barcodes" section in Appendix.
4. Scan the **Save** barcode from the "Save/Cancel Barcodes" section in Appendix.
5. Scan the **Set the Maximum Length** barcode.
6. Scan the numeric barcodes "1" and "2" from the "Digit Barcodes" section in Appendix.
7. Scan the **Save** barcode from the "Save/Cancel Barcodes" section in Appendix.
8. Scan the **Exit Setup** barcode.



@SETUPE0
**** Exit Setup**



@SETUPE1
Enter Setup

ISBT 128

Restore Factory Defaults

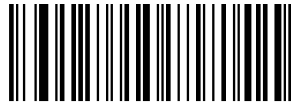

@IBTDEF

Restore the Factory Defaults of ISBT 128

Enable/Disable ISBT 128



@IBTENA1

Enable ISBT 128



@IBTENA0

**** Disable ISBT 128**



If the scanner fails to identify ISBT 128 barcodes, you may first try this solution by scanning the **Enter Setup** barcode and then **Enable ISBT 128** barcode.

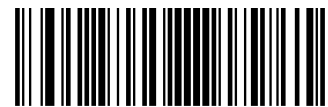

@SETUPE0
**** Exit Setup**



@SETUPE1
Enter Setup

PDF417

Restore Factory Defaults



@PDFDEF
Restore the Factory Defaults of PDF417

Enable/Disable PDF417

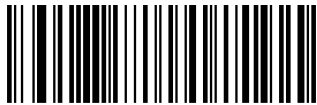

@PDFENA1
** Enable PDF417



@PDFENA0
Disable PDF417



If the scanner fails to identify PDF417 barcodes, you may first try this solution by scanning the **Enter Setup** barcode and then **Enable PDF417** barcode.



@SETUPE0
** Exit Setup



@SETUPE1

Enter Setup

Set Length Range for PDF417

The scanner can be configured to only decode PDF417 barcodes with lengths that fall between (inclusive) the minimum and maximum lengths. To accomplish it, you need to set the minimum and maximum lengths.



@PDFMIN

Set the Minimum Length (Default: 1)

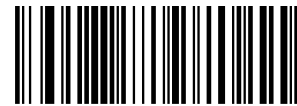

@PDFMAX

Set the Maximum Length (Default: 2710)



Minimum length is not allowed to be greater than maximum length. If you only want to read PDF417 barcodes with a specific length, set both minimum and maximum lengths to be that desired length.

E
sample

Set the scanner to decode PDF417 barcodes containing between 8 and 12 characters:

1. Scan the **Enter Setup** barcode.
2. Scan the **Set the Minimum Length** barcode.
3. Scan the numeric barcode "8" from the "Digit Barcodes" section in Appendix.
4. Scan the **Save** barcode from the "Save/Cancel Barcodes" section in Appendix.
5. Scan the **Set the Maximum Length** barcode.
6. Scan the numeric barcodes "1" and "2" from the "Digit Barcodes" section in Appendix.
7. Scan the **Save** barcode from the "Save/Cancel Barcodes" section in Appendix.
8. Scan the **Exit Setup** barcode.



@SETUPE0

**** Exit Setup**



@SETUPE1
Enter Setup

PDF417 Twin Code

PDF417 twin code is 2 PDF417 barcodes paralleled vertically or horizontally. They must both be either regular or inverse barcodes. They must have similar specifications and be placed closely together.

There are 3 options for reading PDF417 twin codes:

- ◇ **Single PDF417 Only:** Read either PDF417 code.
- ◇ **Twin PDF417 Only:** Read both PDF417 codes.
- ◇ **Both Single & Twin:** Read both PDF417 codes. If successful, transmit as twin PDF417 only. Otherwise, try single PDF417 only.



@PDFDOU0
**** Single PDF417 Only**



@PDFDOU1
Twin PDF417 Only



@PDFDOU2
Both Single & Twin



@SETUPE0
**** Exit Setup**



@SETUPE1
Enter Setup

PDF417 Inverse

Regular barcode: Dark bars on a bright background.

Inverse barcode: Bright bars on a dark background.



@PDFINV0

Decode Regular PDF417 Barcodes Only



@PDFINV1

Decode Inverse PDF417 Barcodes Only



@PDFINV2

**** Decode Both**

Character Encoding



@PDFENC0

**** Default Character Encoding**



@PDFENC1

UTF-8



@SETUPE0
**** Exit Setup**



@SETUPE1
Enter Setup

PDF417 ECI Output



@PDFECI0
Disable PDF417 ECI Output



@PDFECI1
**** Enable PDF417 ECI Output**



@SETUPE0
**** Exit Setup**



@SETUPE1
Enter Setup

QR Code

Restore Factory Defaults



@QRCDEF

Restore the Factory Defaults of QR Code

Enable/Disable QR Code



@QRCENA1

**** Enable QR Code**



@QRCENA0

Disable QR Code



If the scanner fails to identify QR Code barcodes, you may first try this solution by scanning the **Enter Setup** barcode and then **Enable QR Code** barcode.

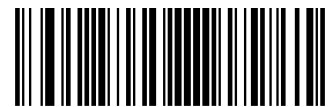

@SETUPE0
**** Exit Setup**



@SETUPE1
Enter Setup

Set Length Range for QR Code

The scanner can be configured to only decode QR Code barcodes with lengths that fall between (inclusive) the minimum and maximum lengths. To accomplish it, you need to set the minimum and maximum lengths.



@QRCEMIN

Set the Minimum Length (Default: 1)



@QRCEMAX

Set the Maximum Length (Default: 7089)



Minimum length is not allowed to be greater than maximum length. If you only want to read QR Code barcodes with a specific length, set both minimum and maximum lengths to be that desired length.

E
example

Set the scanner to decode QR Code barcodes containing between 8 and 12 characters:

1. Scan the **Enter Setup** barcode.
2. Scan the **Set the Minimum Length** barcode.
3. Scan the numeric barcode "8" from the "Digit Barcodes" section in Appendix.
4. Scan the **Save** barcode from the "Save/Cancel Barcodes" section in Appendix.
5. Scan the **Set the Maximum Length** barcode.
6. Scan the numeric barcodes "1" and "2" from the "Digit Barcodes" section in Appendix.
7. Scan the **Save** barcode from the "Save/Cancel Barcodes" section in Appendix.
8. Scan the **Exit Setup** barcode.

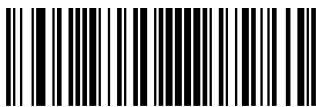

@SETUPE0
**** Exit Setup**



@SETUPE1
Enter Setup

QR Twin Code

QR twin code is 2 QR barcodes paralleled vertically or horizontally. They must both be either regular or inverse barcodes. They must have similar specifications and be placed closely together.

There are 3 options for reading QR twin codes:

Single QR Only: Read either QR code.

Twin QR Only: Read both QR codes. Transmission sequence: left (upper) QR code followed by right (lower) QR code.

Both Single & Twin: Read both QR codes. If successful, transmit as twin QR only. Otherwise, try single QR only.



@QRCDU0
**** Single QR Only**



@QRCDU1
Twin QR Only



@QRCDU2
Both Single & Twin

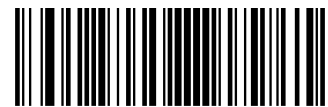

@SETUPE0
**** Exit Setup**



@SETUPE1
Enter Setup

QR Inverse

Regular barcode: Dark bars on a bright background.

Inverse barcode: Bright bars on a dark background.



@QRCINV0
Decode Regular QR Barcodes Only



@QRCINV1
Decode Inverse QR Barcodes Only



@QRCINV2
** Decode Both

Character Encoding



@QRCENC0
** Default Character Encoding



@QRCENC1
UTF-8



@SETUPE0
** Exit Setup



@SETUPE1
Enter Setup

QR ECI Output



@QRCECI0
Disable QR ECI Output



@QRCECI1
**** Enable QR ECI Output**

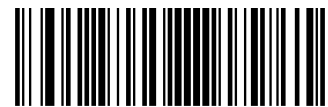

@SETUPE0
**** Exit Setup**



@SETUPE1
Enter Setup

Aztec

Restore Factory Defaults



@AZTDEF
Restore the Factory Defaults of Aztec Code

Enable/Disable Aztec Code



@AZTENA1
Enable Aztec Code



@AZTENA0
** Disable Aztec Code



If the scanner fails to identify Aztec Code barcodes, you may first try this solution by scanning the **Enter Setup** barcode and then **Enable Aztec Code** barcode.



@SETUPE0
** Exit Setup



@SETUPE1
Enter Setup

Set Length Range for Aztec Code

The scanner can be configured to only decode Aztec barcodes with lengths that fall between (inclusive) the minimum and maximum lengths. To accomplish it, you need to set the minimum and maximum lengths.



Set the Minimum Length (Default: 1)



Set the Maximum Length (Default: 3832)



Minimum length is not allowed to be greater than maximum length. If you only want to read Aztec barcodes with a specific length, set both minimum and maximum lengths to be that desired length.

E
sample

Set the scanner to decode Aztec barcodes containing between 8 and 12 characters:

1. Scan the **Enter Setup** barcode.
2. Scan the **Set the Minimum Length** barcode.
3. Scan the numeric barcode “8” from the “Digit Barcodes” section in Appendix.
4. Scan the **Save** barcode from the “Save/Cancel Barcodes” section in Appendix.
5. Scan the **Set the Maximum Length** barcode.
6. Scan the numeric barcodes “1” and “2” from the “Digit Barcodes” section in Appendix.
7. Scan the **Save** barcode from the “Save/Cancel Barcodes” section in Appendix.
8. Scan the **Exit Setup** barcode.



@SETUPE0
**** Exit Setup**



@SETUPE1
Enter Setup

Read Multi-barcodes on an Image

There are three options:

Mode 1: Read one barcode only.

Mode 2: Read fixed number of barcodes only.

Mode 3: Composite Reading. Read fixed number of barcodes first. If unsuccessful, read one barcode only.

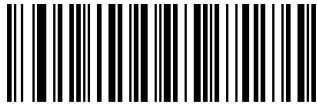

@AZTMOD1
**** Mode 1**



@AZTMOD2
Mode 2

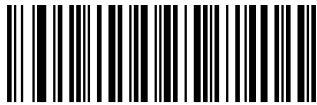

@AZTMOD3
Mode 3



@SETUPE0
**** Exit Setup**



@SETUPE1
Enter Setup

Set the Number of Barcodes



@AZTMUL1
** 1



@AZTMUL2
2

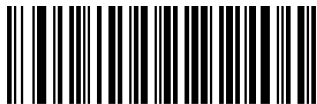

@AZTMUL3
3



@AZTMUL4
4

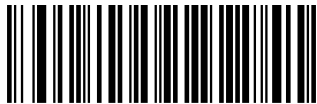

@AZTMUL5
5



@AZTMUL6
6

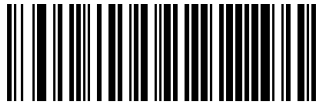

@AZTMUL7
7



@AZTMUL8
8



@SETUPE0
** Exit Setup



@SETUPE1
Enter Setup

Character Encoding



@AZTENC0
** Default Character Encoding



@AZTENC1
UTF-8

Aztec ECI Output



@AZTECI0
Disable Aztec ECI Output



@AZTECI1
** Enable Aztec ECI Output



@SETUPE0
** Exit Setup



@SETUPE1
Enter Setup

Data Matrix

Restore Factory Defaults



@DMCDEF

Restore the Factory Defaults of Data Matrix

Enable/Disable Data Matrix



@DMCENA1

**** Enable Data Matrix**



@DMCENA0

Disable Data Matrix



If the scanner fails to identify Data Matrix barcodes, you may first try this solution by scanning the **Enter Setup** barcode and then **Enable Data Matrix** barcode.

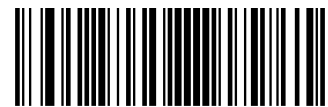

@SETUPE0
**** Exit Setup**



@SETUPE1
Enter Setup

Set Length Range for Data Matrix

The scanner can be configured to only decode Data Matrix barcodes with lengths that fall between (inclusive) the minimum and maximum lengths. To accomplish it, you need to set the minimum and maximum lengths.



@DMCMIN

Set the Minimum Length (Default: 1)



@DMCMAX

Set the Maximum Length (Default: 3116)



Minimum length is not allowed to be greater than maximum length. If you only want to read Data Matrix barcodes with a specific length, set both minimum and maximum lengths to be that desired length.



Set the scanner to decode Data Matrix barcodes containing between 8 and 12 characters:

1. Scan the **Enter Setup** barcode.
2. Scan the **Set the Minimum Length** barcode.
3. Scan the numeric barcode "8" from the "Digit Barcodes" section in Appendix.
4. Scan the **Save** barcode from the "Save/Cancel Barcodes" section in Appendix.
5. Scan the **Set the Maximum Length** barcode.
6. Scan the numeric barcodes "1" and "2" from the "Digit Barcodes" section in Appendix.
7. Scan the **Save** barcode from the "Save/Cancel Barcodes" section in Appendix.
8. Scan the **Exit Setup** barcode.



@SETUPE0
**** Exit Setup**



@SETUPE1

Enter Setup

Data Matrix Twin Code

Data Matrix twin code is 2 Data Matrix barcodes paralleled vertically or horizontally. They must both be either regular or inverse barcodes. They must have similar specifications and be placed closely together.

There are 3 options for reading Data Matrix twin codes:

Single Data Matrix Only: Read either Data Matrix code.

Twin Data Matrix Only: Read both Data Matrix codes. Transmission sequence: left (upper) Data Matrix code followed by right (lower) Data Matrix code.

Both Single & Twin: Read both Data Matrix codes. If successful, transmit as twin Data Matrix only. Otherwise, try single Data Matrix only.



@DMCDOU0

**** Single Data Matrix Only**

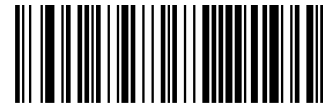

@DMCDOU1

Twin Data Matrix Only



@DMCDOU2

Both Single & Twin

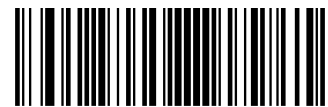

@SETUPE0

**** Exit Setup**



@SETUPE1
Enter Setup

Rectangular Barcode

Data Matrix has two formats:

Square barcodes having the same amount of modules in length and width: 10*10, 12*12.... 144*144.

Rectangular barcodes having different amounts of models in length and width: 6*16, 6*14...14*22.



@DMCREC1
**** Enable Rectangular Barcode**



@DMCREC0
Disable Rectangular Barcode

Data Matrix Inverse

Regular barcode: Dark bars on a bright background.

Inverse barcode: Bright bars on a dark background.



@DMCINV0
**** Decode Regular Data Matrix Barcodes Only**



@DMCINV1
Decode Inverse Data Matrix Barcodes Only



@DMCINV2
Decode Both



@SETUPE0
**** Exit Setup**



@SETUPE1
Enter Setup

Character Encoding



@DMCENC0

**** Default Character Encoding**



@DMCENC1

UTF-8

Data Matrix ECI Output



@DMCEC0

Disable Data Matrix ECI Output



@DMCEC1

**** Enable Data Matrix ECI Output**



@SETUPE0
**** Exit Setup**



@SETUPE1
Enter Setup

Chapter 5 Data Formatter

Introduction

You may use the Data Formatter to modify the scanner's output. For example, you can use the Data Formatter to insert characters at certain points in barcode data or to suppress/ replace/ send certain characters in barcode data as it is scanned.

Normally, when you scan a barcode, it gets outputted automatically; however, when you create a format, you must use a "send" command (see the "Send Commands" section in this chapter) within the format programming to output data. The maximum size of all data formats (up to four data formats) created is 2048 characters. By default, the data formatter is disabled. Enable it when required. If you have changed data format settings, and wish to clear all formats and return to the factory defaults, scan the **Default Data Format** code below.



@DFMDEF
Default Data Format

Add a Data Format

Data format is used to edit barcode data only. You can program up to four data formats, i.e. Format_0, Format_1, Format_2 and Format_3. When you create a data format, you must specify the application scope of your data format (such as barcode type and data length) and include formatter commands. When scanned data does not match your data format requirements, you will hear the non-match error beep (if the non-match error beep is ON).

There are two methods to program a data format: Programming with barcodes and programming with serial commands.

Programming with Barcodes

The following explains how to program a data format by scanning the specific barcodes. Scanning any irrelevant barcode or failing to follow the setting procedure will result in programming failure. To find the alphanumeric barcodes needed to create a data format, see the "Digit Barcodes" section in Appendix.

Step 1: Scan the **Enter Setup** barcode.



@SETUPE0
**** Exit Setup**



@SETUPE1
Enter Setup

Step 2: Scan the **Add Data Format** barcode.



Add Data Format

Step 3: Select data format.

Scan a numeric barcode **0** or **1** or **2** or **3** to set this to Format_0 or Format_1 or Format_2 or Format_3.

Step 4: Select formatter command type.

Specify what type of formatter commands will be used. Scan a numeric barcode “6” to select formatter command type 6. (See the “Formatter Command Type 6” section in this chapter for more information)

Step 5: Set interface type

Scan **999** for any interface type.

Step 6: Set Symbology ID Number

Refer to the “Symbology ID Number” section in Appendix and find the ID number of the symbology to which you want to apply the data format. Scan three numeric barcodes for the symbology ID number. If you wish to create a data format for all symbologies, scan **999**.

Step 7: Set barcode data length

Specify what length of data will be acceptable for this symbology. Scan the four numeric barcodes that represent the data length. 9999 is a universal number, indicating all lengths. For example, 32 characters should be entered as 0032.

Step 8: Enter formatter command

Refer to the “Formatter Command Type 6” section in this chapter. Scan the alphanumeric barcodes that represent the command you need to edit data. For example, when a command is F141, you should scan F141.

Step 9: Scan the **Save** barcode from the “Save/Cancel Barcodes” section in Appendix to save your data format.

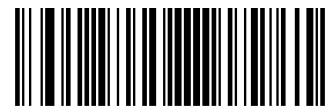

@SETUPE0
**** Exit Setup**



@SETUPE1
Enter Setup

Example: Program format_0 using formatter command type 6, Code 128 containing 10 characters applicable, send all characters followed by “A”.

- | | |
|---|---|
| 1. Scan the Enter Setup barcode | Enter the Setup mode |
| 2. Scan the Add Data Format barcode | Add a data format |
| 3. Scan the 0 barcode | Select format_0 |
| 4. Scan the 6 barcode | Select formatter command type 6 |
| 5. Scan the 9 barcode three times | All interface types applicable |
| 6. Scan the barcodes 002 | Only Code 128 applicable |
| 7. Scan the barcodes 0010 | Only a length of 10 characters applicable |
| 8. Scan the alphanumeric barcodes F141 | Send all characters followed by “A” (HEX: 41) |
| 9. Scan the Save barcode | Save the data format |

To streamline the programming process, you may as well generate a batch barcode by inputting the batch command (e.g. **@DFMADD069990020010F141**;) used to create a data format. See the “**Use Batch Barcode**” section in Chapter 10 to learn how to put a batch barcode into use.

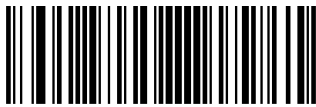

@SETUPE0
**** Exit Setup**



@SETUPE1
Enter Setup

Programming with Serial Commands

A data format can also be created by serial commands (HEX) sent from the host device. **All commands must be entered in uppercase letters.**

The syntax consists of the following elements:

Prefix: “~<SOH>0000” (HEX: **7E 01 30 30 30 30**), 6 characters.

Storage type: “@” (HEX: **40**) or “#” (HEX: **23**), 1 character. “@” means permanent setting which will not be lost by removing power from the scanner or rebooting it; “#” means temporary setting which will be lost by removing power from the scanner or rebooting it.

Add Data Format Command: “DFMADD” (HEX: **44 46 4D 41 44 44**), 6 characters.

Data format: “0” (HEX: **30**) or “1” (HEX: **31**) or “2” (HEX: **32**) or “3” (HEX: **33**), 1 character. “0”, “1”, “2” and “3” represent Format_0, Format_1, Format_2 and Format_3 respectively.

Formatter command type: “6” (HEX: **36**), 1 character.

Interface type: “999” (HEX: **39 39 39**), 3 characters.

Symbology ID Number: The ID number of the symbology to which you want to apply the data format, 3 characters. 999 indicates all symbologies.

Data length: The length of data that will be acceptable for this symbology, 4 characters. 9999 indicates all lengths. For example, 32 characters should be entered as 0032.

Formatter commands: The command string used to edit data. For more information, see the “Formatter Command Type 6” section in this chapter.

Suffix: “;<ETX>” (HEX: **3B 03**), 2 characters.

Example: Program format_0 using formatter command type 6, Code 128 containing 10 characters applicable, send all characters followed by “A”.

Enter: **7E 01 30 30 30 30 40 44 46 4D 41 44 44 30 36 39 39 39 30 30 33 39 39 39 39 46 31 34 31 3B 03**

(~<SOH>0000@DFMADD069990020010F141;<ETX>)

Response: **02 01 30 30 30 30 40 44 46 4D 41 44 44 30 36 39 39 39 30 30 33 39 39 39 39 46 31 34 31 06 3B 03**

(<STX><SOH>0000@DFMADD069990020010F141<ACK>;<ETX>)

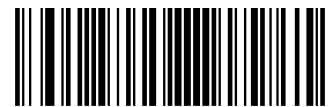

@SETUPE0
** Exit Setup



@SETUPE1
Enter Setup

Enable/Disable Data Formatter

When Data Formatter is disabled, the barcode data is outputted to the host as read, including prefixes and suffixes.



** Disable Data Formatter

You may wish to require the data to conform to a data format you have created. The following settings can be applied to your data format:

Enable Data Formatter, Required, Keep Prefix/Suffix: Scanned data that meets your data format requirements is modified accordingly and gets outputted along with prefixes and suffixes (if prefix and suffix are enabled). Any data that does not match your data format requirements generates an error beep (if Non-Match Error Beep is turned ON) and the data in that barcode is not transmitted.

Enable Data Formatter, Required, Drop Prefix/Suffix: Scanned data that meets your data format requirements is modified accordingly and gets outputted without prefixes and suffixes (even if prefix and suffix are enabled). Any data that does not match your data format requirements generates an error beep (if Non-Match Error Beep is turned ON) and the data in that barcode is not transmitted.

Enable Data Formatter, Not Required, Keep Prefix/Suffix: Scanned data that meets your data format requirements is modified accordingly and gets outputted along with prefixes and suffixes (if prefix and suffix are enabled). Barcode data that does not match your data format requirements is transmitted as read along with prefixes and suffixes (if prefix and suffix are enabled).

Enable Data Formatter, Not Required, Drop Prefix/Suffix: Scanned data that meets your data format requirements is modified accordingly and gets outputted without prefixes and suffixes (even if prefix and suffix are enabled). Barcode data that does not match your data format requirements is transmitted as read along with prefixes and suffixes (if prefix and suffix are enabled).



@SETUPE0
** Exit Setup



@SETUPE1
Enter Setup



@DFMENA1

Enable Data Formatter, Required, Keep Prefix/Suffix



@DFMENA2

Enable Data Formatter, Required, Drop Prefix/Suffix

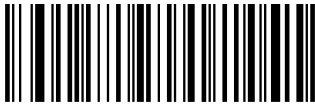

@DFMENA3

Enable Data Formatter, Not Required, Keep Prefix/Suffix



@DFMENA4

Enable Data Formatter, Not Required, Drop Prefix/Suffix

Non-Match Error Beep

If Non-Match Error Beep is turned ON, the scanner generates an error beep when a barcode is encountered that does not match your required data format.



@DFMTON0

Non-Match Error Beep Off

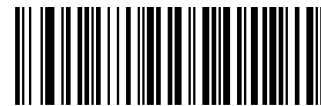

@DFMTON1

** Non-Match Error Beep On

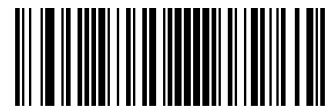

@SETUPE0
** Exit Setup



@SETUPE1
Enter Setup

Data Format Selection

After enabling the Data Formatter, you can select a data format you want to use by scanning the appropriate barcode below.



@DFMUSE0
**** Format_0**



@DFMUSE2
Format_2



@DFMUSE1
Format_1



@DFMUSE3
Format_3



@SETUPE0
**** Exit Setup**



@SETUPE1
Enter Setup

Change Data Format for a Single Scan

You can switch between data formats for a single scan. The next barcode is scanned using the data format selected here, then reverts to the format you have selected above.

For example, you may have set your scanner to use the data format you saved as Format_3. You can switch to Format_1 for a single trigger pull by scanning the **Single Scan – Format_1** barcode below. The next barcode that is scanned uses Format_1, then reverts back to Format_3.

Note: This setting will be lost by removing power from the scanner, or turning off/ rebooting the device.



@DFMSIN0
Single Scan – Format_0



@DFMSIN2
Single Scan – Format_2



@DFMSIN1
Single Scan – Format_1



@DFMSIN3
Single Scan – Format_3

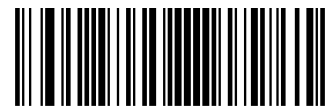

@SETUPE0
**** Exit Setup**



@SETUPE1
Enter Setup

Clear Data Format

There are two methods to remove data format created from your scanner:

Delete one data format: Scan the **Clear One** barcode, a numeric barcode (0-3) and the **Save** barcode. For example, to delete Format_2, you should scan the **Clear One** barcode, the **2** barcode and the **Save** barcode

Delete all data formats: Scan the **Clear All** barcode.

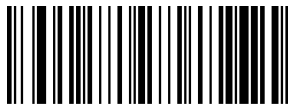

@DFMCAL
Clear All



@DFMCLR
Clear One

Query Data Formats

You may scan the appropriate barcode below to get the information of data format(s) created by you or preset by manufacturer. For instance, if you have added Format_0 as per the example in the “Add a Data Format” section in this chapter, scanning the **Query Current Data Formats** barcode, you will get the result: **Data Format0:069990020010F141;**

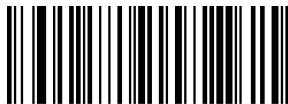

@DFMQCU
Query Current Data Formats



@DFMQFA
Query Preset Data Formats



@SETUPE0
** Exit Setup



@SETUPE1
Enter Setup

Formatter Command Type 6

When working with the Data Formatter, a virtual cursor is moved along your input data string. The following commands are used to both move this cursor to different positions, and to select, replace, and insert data into the final output. For the hex value of ASCII characters involved in the commands, refer to the “ASCII Table” in Appendix.

Send Commands

F1 Send all characters

Syntax=F1xx (xx: The insert character’s hex value)

Include in the output message all of the characters from the input message, starting from current cursor position, followed by an insert character.

F2 Send a number of characters

Syntax=F2nxx (nn: The numeric value (00-99) for the number of characters; xx: The insert character’s hex value)

Include in the output message a number of characters followed by an insert character. Start from the current cursor position and continue for “nn” characters or through the last character in the input message, followed by character “xx.”

F2 Example: Send a number of characters



Send the first 10 characters from the barcode above, followed by a carriage return.

Command string: **F2100D**

F2 is the “Send a number of characters” command

10 is the number of characters to send

0D is the hex value for a CR

The data is output as: **1234567890**

<CR>



@SETUPE0
** Exit Setup



@SETUPE1
Enter Setup

F3 Send all characters up to a particular character

Syntax=F3ssxx (ss: The particular character's hex value; xx: The insert character's hex value)

Include in the output message all characters from the input message, starting with the character at the current cursor position and continuing to, but not including, the particular character "ss," followed by character "xx." The cursor is moved forward to the "ss" character.

F3 Example: Send all characters up to a particular character



Using the barcode above, send all characters up to but not including "D," followed by a carriage return.

Command string: **F3440D**

F3 is the "Send all characters up to a particular character" command

44 is the hex value for a "D"

0D is the hex value for a CR

The data is output as: **1234567890ABC**
<CR>

B9 Send all characters up to a string

Syntax=B9nnnns...s (nnnn: the length of the string; s...s: the string to be matched)

Include in the output message all characters from the input message, starting with the character at the current cursor position and continuing to, but not including, the string "s...s." The cursor is moved forward to the beginning of the "s...s" string.

B9 Example: Send all characters up to a defined string



@SETUPE0
**** Exit Setup**



@SETUPE1
Enter Setup

Using the barcode above, send all characters up to but not including "AB".

Command string: **B900024142**

B9 is the "Send all characters up to a string" command

0002 is the length of the string (2 characters)

41 is the hex value for "A"

42 is the hex value for "B"

The data is output as: **1234567890**

E9 Send all but the last characters

Syntax=E9nn (nn: The numeric value (00-99) for the number of characters that will not be sent at the end of the message)

Include in the output message all but the last "nn" characters, starting from the current cursor position. The cursor is moved forward to one position past the last input message character included.

F4 Insert a character multiple times

Syntax=F4xxnn (xx: The insert character's hex value; nn: The numeric value (00-99) for the number of times it should be sent)

Send "xx" character "nn" times in the output message, leaving the cursor in the current position.

E9 and F4 Example: Send all but the last characters, followed by 2 tabs



Send all characters except for the last 8 from the barcode above, followed by 2 tabs.

Command string: **E908F40902**

E9 is the "Send all but the last characters" command

08 is the number of characters at the end to ignore



@SETUPE0
** Exit Setup



@SETUPE1

Enter Setup

F4 is the "Insert a character multiple times" command

09 is the hex value for a horizontal tab

02 is the number of time the tab character is sent

The data is output as: **1234567890AB<tab><tab>**

B3 Insert symbology name

Insert the name of the barcode's symbology in the output message, without moving the cursor.

B4 Insert barcode length

Insert the barcode's length in the output message, without moving the cursor. The length is expressed as a numeric string and does not include leading zeros.



@SETUPE0

**** Exit Setup**



@SETUPE1
Enter Setup

B3 and B4 Example: Insert the symbology name and length



Send the symbology name and length before the barcode data from the barcode above. Break up these insertions with spaces. End with a carriage return.

Command string: **B3F42001B4F42001F10D**

B3 is the “Insert symbology name” command

F4 is the “Insert a character multiple times” command

20 is the hex value for a space

01 is the number of time the space character is sent

B4 is the “Insert barcode length” command

F4 is the “Insert a character multiple times” command

20 is the hex value for a space

01 is the number of time the space character is sent

F1 is the “Send all characters” command

0D is the hex value for a CR

The data is output as: **Code128 20 1234567890ABCDEFGHIJ**

<CR>

Move Commands

F5 Move the cursor forward a number of characters

Syntax=F5nn (nn: The numeric value (00-99) for the number of characters the cursor should be moved ahead)

Move the cursor ahead “nn” characters from current cursor position.



@SETUPE0
** Exit Setup



@SETUPE1
Enter Setup

F5 Example: Move the cursor forward and send the data



Move the cursor forward 3 characters, then send the rest of the barcode data from the barcode above. End with a carriage return.

Command string: **F503F10D**

F5 is the "Move the cursor forward a number of characters" command

03 is the number of characters to move the cursor

F1 is the "Send all characters" command

0D is the hex value for a CR

The data is output as: **4567890ABCDEFGHIJ**

<CR>

F6 Move the cursor backward a number of characters

Syntax=F6nn (nn: The numeric value (00-99) for the number of characters the cursor should be moved back)

Move the cursor back "nn" characters from current cursor position.

F7 Move the cursor to the beginning

Syntax=F7

Move the cursor to the first character in the input message.

EA Move the cursor to the end

Syntax=EA

Move the cursor to the last character in the input message.



@SETUPE0
** Exit Setup



@SETUPE1
Enter Setup

Search Commands

F8 Search forward for a character

Syntax=F8xx (xx: The search character's hex value)

Search the input message forward for "xx" character from the current cursor position, leaving the cursor pointing to the "xx" character.

F8 Example: Send barcode data that starts after a particular character



Search for the letter "D" in barcodes and send all the data that follows, including the "D". Using the barcode above:

Command string: **F844F10D**

F8 is the "Search forward for a character" command

44 is the hex value for "D"

F1 is the "Send all characters" command

0D is the hex value for a CR

The data is output as: **DEFGHIJ**

<CR>

F9 Search backward for a character

Syntax=F9xx(xx: The search character's hex value)

Search the input message backward for "xx" character from the current cursor position, leaving the cursor pointing to the "xx" character.



@SETUPE0
** Exit Setup



@SETUPE1
Enter Setup

B0 Search forward for a string

Syntax=B0nnnnS (nnnn: The string length (up to 9999); S: The ASCII hex value of each character in the string)

Search forward for "S" string from the current cursor position, leaving cursor pointing to "S" string. For example, B0000454657374 will search forward for the first occurrence of the 4-character string "Test."

B0 Example: Send barcode data that starts after a string of characters



Search for the letters "FGH" in barcodes and send all the data that follows, including "FGH." Using the barcode above:

Command string: **B00003464748F10D**

B0 is the "Search forward for a string" command

0003 is the string length (3 characters)

46 is the hex value for "F"

47 is the hex value for "G"

48 is the hex value for "H"

F1 is the "Send all characters" command

0D is the hex value for a CR

The data is output as: **FGHIJ**

<CR>

B1 Search backward for a string

Syntax=B1nnnnS (nnnn: The string length (up to 9999); S: The ASCII hex value of each character in the string)

Search backward for "S" string from the current cursor position, leaving cursor pointing to "S" string. For example, B1000454657374 will search backward for the first occurrence of the 4-character string "Test."



@SETUPE0
** Exit Setup



@SETUPE1
Enter Setup

E6 Search forward for a non-matching character

Syntax=E6xx (xx: The search character's hex value)

Search the input message forward for the first non-"xx" character from the current cursor position, leaving the cursor pointing to the non-"xx" character.

E6 Example: Remove zeros at the beginning of barcode data



This example shows a barcode that has been zero filled. You may want to ignore the zeros and send all the data that follows. E6 searches forward for the first character that is not zero, then sends all the data after, followed by a carriage return. Using the barcode above:

Command string: **E630F10D**

E6 is the "Search forward for a non-matching character" command

30 is the hex value for 0

F1 is the "Send all characters" command

0D is the hex value for a CR

The data is output as: **37692**

<CR>

E7 Search backward for a non-matching character

Syntax=E7xx(xx: The search character's hex value)

Search the input message backward for the first non-"xx" character from the current cursor position, leaving the cursor pointing to the non-"xx" character.



@SETUPE0
** Exit Setup



@SETUPE1
Enter Setup

Miscellaneous Commands

FB Suppress characters

Syntax=FBnnxxyy..zz (nn: The numeric value (00-15) for the number of suppressed characters; xxyy..zz: The hex value of the characters to be suppressed)

Suppress all occurrences of up to 15 different characters, starting at the current cursor position, as the cursor is advanced by other commands.

FB Example: Remove spaces in barcode data



This example shows a barcode that has spaces in the data. You may want to remove the spaces before sending the data. Using the barcode above:

Command string: **FB0120F10D**

FB is the "Suppress characters" command

01 is the number of the characters to be suppressed

20 is the hex value for a space

F1 is the "Send all characters" command

0D is the hex value for a CR

The data is output as: **34567890**

<CR>

E4 Replace characters

Syntax=E4nnxx₁xx₂yy₁yy₂...zz₁zz₂(nn: The total count of the number of characters (characters to be replaced plus replacement characters; xx₁: The characters to be replaced, xx₂: The replacement characters, continuing through zz₁ and zz₂)

Replace up to 15 characters in the output message, without moving the cursor.



@SETUPE0
**** Exit Setup**



@SETUPE1
Enter Setup

E4 Example: Replace zeros with CRs in barcode data



If the barcode has characters that the host application does not want included, you can use the E4 command to replace those characters with something else. In this example, you will replace the zeros in the barcode above with carriage returns.

Command string: **E402300DF10D**

E4 is the "Replace characters" command

02 is the total count of characters to be replaced, plus the replacement characters (0 is replaced by CR, so total characters=2)

30 is the hex value for 0

0D is the hex value for a CR (the character that will replace the 0)

F1 is the "Send all characters" command

0D is the hex value for a CR

The data is output as: **1234**

5678

ABC

<CR>

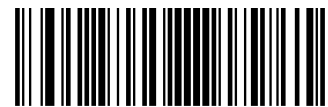

@SETUPE0
** Exit Setup



@SETUPE1
Enter Setup

BA Replace a string with another

Syntax = BAnnNN₁SS₁NN₂SS₂

nn: The count of replacements to be made, if nn=00 or nn>=the number of occurrences of a string to be replaced, then replace all occurrences of that string.

NN₁: The length of the string to be replaced, NN₁>0.

SS₁: The ASCII hex value of each character in the string to be replaced.

NN₂: The length of replacement string, NN₂>=0. To replace string "SS₁" with NUL (i.e. delete string "SS₁"), you should set NN₂ to 00 and leave out SS₂.

SS₂: The ASCII hex value of each character in the replacement string.

From the current cursor position, search forward for the occurrence of "SS₁" string (of length "NN₁") and replace the string with "SS₂" string (of length "NN₂") in the output message until every "SS₁" string is replaced or the count of replacements made reaches "nn" times, without moving the cursor.

BA Example: Replace "23"s with "ABC"s in barcode data



cd123abc23bc12ab232

If the barcode has a string of characters that the host application does not want included, you can use the BA command to replace the string with something else. In this example, you will replace the "23"s in the barcode above with "ABC"s.

Command string: **BA0002323303414243F100**

BA is the "Replace a string with another" command

00 is the count of replacements to be made, 00 means to replace all occurrences of that string

02 is the length of the string to be replaced



@SETUPE0
** Exit Setup



@SETUPE1
Enter Setup

32 is the hex value for 2 (character in the string to be replaced)

33 is the hex value for 3 (character in the string to be replaced)

03 is the length of the replacement string

41 is the hex value for A (character in the replacement string)

42 is the hex value for B (character in the replacement string)

43 is the hex value for C (character in the replacement string)

F1 is the "Send all characters" command

00 is the hex value for a NUL

The data is output as: **cd1ABCabcABCbc12abABC2**

BA Example: Remove only the first occurrence of "23"s in barcode data

If the barcode has a string of characters that the host application wants removed, you can use the BA command to replace the string with NUL. In this example, you will remove the first occurrence of "23" in the barcode above.

Command string: **BA0102323300F100**

BA is the "Replace a string with another" command

01 is the count of replacements to be made

02 is the length of the string to be replaced

32 is the hex value for 2 (character in the string to be replaced)

33 is the hex value for 3 (character in the string to be replaced)

00 is the length of the replacement string, 00 means to replace the string to be replaced with NUL

F1 is the "Send all characters" command

00 is the hex value for a NUL

The data is output as: **cd1abc23bc12ab232**



@SETUPE0
** Exit Setup



@SETUPE1
Enter Setup

EF Insert a delay

Syntax=EFnnnn (nnnn: The delay in 5ms increments, up to 9999)

Inserts a delay of up to 49,995 milliseconds (in multiples of 5), starting from the current cursor position. This command can only be used with USB HID Keyboard.

EF Example: Insert a delay of 1s between the 5th and 6th character

Send the first 5 characters in a barcode, wait for 1s, then send the rest of the barcode data.

Command string: **F20500EF0200E900**

F2 is the "Send a number of characters" command

05 is the number of characters to send

00 is the hex value for a Null character

EF is the "Insert a delay" command

0200 is the delay value (5msX200=1000ms=1s)

E9 is the "Send all but the last characters" command

00 is the number of characters that will not be sent at the end of the message

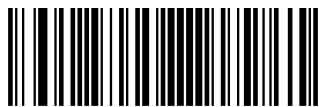

@SETUPE0
**** Exit Setup**



@SETUPE1
Enter Setup

B5 Insert key strokes

Syntax=B5nnssxx (nn: The number of keys pressed (without key modifiers); ss: the key modifier from the table below; xx: the key number from the “Unicode Key Maps” in Appendix.)

Insert a key stroke or combination of key strokes. Key strokes are dependent on your keyboard (see the “Unicode Key Maps” in Appendix). This command can only be used with USB HID Keyboard.

Key Modifiers	
No Key Modifier	00
Shift Left	01
Shift Right	02
Alt Left	04
Alt Right	08
Control Left	10
Control Right	20

For example, B501001F inserts an “a” on a U.S. style keyboard. B5 = the command, 01 = number of keys pressed (without the key modifier), 00 is No Key Modifier, and 1F is the “a” key. If an “A” were to be inserted, B501011F or B501021F would be entered.

If there are two keystrokes, the syntax would change from Syntax=B5nnssxx for one keystroke to Syntax=B5nnssxxssxx. An example that would insert “aA” is as follows: B502001F011F.

Note: Key modifiers can be added together when needed. Example: Shift Left + Alt Left + Control Left =15.

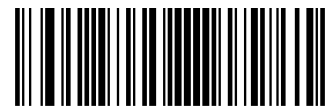

@SETUPE0
** Exit Setup



@SETUPE1
Enter Setup

Chapter 6 Prefix & Suffix

Introduction

A 1D barcode could contain digits, letters, symbols, etc. A 2D barcode could contain more data, such as Chinese characters and other multi-byte characters. However, in real applications, they do not and should not have all information we need, such as barcode type, data acquisition time and delimiter, in order to keep the barcodes short and flexible.

Prefix and suffix are how to fulfill the needs mentioned above. They can be added, removed and modified while the original barcode data remains intact.



Barcode processing procedure:

1. Edit data with Data Formatter
2. Append prefix/suffix
3. Pack data
4. Append terminating character



@SETUPE0
** Exit Setup



@SETUPE1
Enter Setup

Global Settings

Enable/Disable All Prefixes/Suffixes

Disable All Prefixes/Suffixes: Transmit barcode data with no prefix/suffix.

Enable All Prefixes/Suffixes: Allow to append Code ID prefix, AIM ID prefix, custom prefix/suffix and terminating character to the barcode data before the transmission.



@APSENA0

**** Disable All Prefixes/Suffixes**



@APSENA1

Enable All Prefixes/Suffixes

Prefix Sequence



@PRESEQ0

**** Code ID+ Custom +AIM ID**



@PRESEQ1

Custom + Code ID + AIM ID



@SETUPE0
**** Exit Setup**



@SETUPE1
Enter Setup

Custom Prefix

Enable/Disable Custom Prefix

If custom prefix is enabled, you are allowed to append to the data a user-defined prefix that cannot exceed 10 characters. For example, if the custom prefix is “AB” and the barcode data is “123”, the Host will receive “AB123”.



@CPRENA0
**** Disable Custom Prefix**



@CPRENA1
Enable Custom Prefix

Set Custom Prefix

To set a custom prefix, scan the **Set Custom Prefix** barcode then the numeric barcodes corresponding to the hexadecimal value of a desired prefix then the **Save** barcode.

Note: A custom prefix cannot exceed 10 characters.



@CPRSET
Set Custom Prefix

E
xample

Set the custom prefix to “CODE” (HEX: 0x43/0x4F/0x44/0x45):

1. Scan the **Enter Setup** barcode.
2. Scan the **Set Custom Prefix** barcode.
3. Scan the numeric barcodes “4”, “3”, “4”, “F”, “4”, “4”, “4” and “5” from the “Digit Barcodes” section in Appendix.
4. Scan the **Save** barcode from the “Save/Cancel Barcodes” section in Appendix.
5. Scan the **Enable Custom Prefix** barcode.
6. Scan the **Exit Setup** barcode.



@SETUPE0
**** Exit Setup**



@SETUPE1
Enter Setup

AIM ID Prefix

AIM (Automatic Identification Manufacturers) ID defines symbology identifier (For the details, see the “AIM ID Table” section in Appendix). If AIM ID prefix is enabled, the scanner will add the symbology identifier before the scanned data after decoding.



@AIDENA0
**** Disable AIM ID Prefix**



@AIDENA1
Enable AIM ID Prefix



AIM ID is not user programmable.

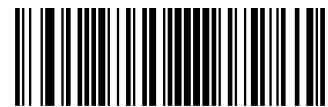

@SETUPE0
**** Exit Setup**



@SETUPE1
Enter Setup

Code ID Prefix

Code ID can also be used to identify barcode type. Unlike AIM ID, Code ID is user programmable. Code ID can only consist of one or two English letters.



@CIDENA0
**** Disable Code ID Prefix**



@CIDENA1
Enable Code ID Prefix

Restore All Default Code IDs

For the information of default Code IDs, see the “Code ID Table” section in Appendix.



@CIDDEF
Restore All Default Code IDs

Modify Code ID

See the examples below to learn how to modify a Code ID and restore the default Code IDs of all symbologies.



@SETUPE0
**** Exit Setup**



@SETUPE1
Enter Setup

E
sample

Modify PDF417 Code ID to be “p” (HEX: 0x70):

1. Scan the **Enter Setup** barcode.
2. Scan the **Modify PDF417 Code ID** barcode.
3. Scan the numeric barcodes “7” and “0” from the “Digit Barcodes” section in Appendix.
4. Scan the **Save** barcode from the “Save/Cancel Barcodes” section in Appendix.
5. Scan the **Exit Setup** barcode.

Restore the default Code IDs of all symbologies:

1. Scan the **Enter Setup** barcode.
2. Scan the **Restore All Default Code IDs** barcode.
3. Scan the **Exit Setup** barcode.

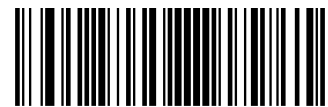

@SETUPE0
**** Exit Setup**



@SETUPE1
Enter Setup

1D symbologies:



@CID002
Modify Code 128 Code ID



@CID003
Modify GS1-128 Code ID



@CID004
Modify EAN-8 Code ID



@CID005
Modify EAN-13 Code ID



@CID006
Modify UPC-E Code ID



@CID007
Modify UPC-A Code ID



@CID008
Modify Interleaved 2 of 5 Code ID



@SETUPE0
**** Exit Setup**



@SETUPE1

Enter Setup



@CID009

Modify ITF-14 Code ID



@CID010

Modify ITF-6 Code ID



@CID011

Modify Matrix 2 of 5 Code ID



@CID013

Modify Code 39 Code ID



@CID015

Modify Codabar Code ID



@CID017

Modify Code 93 Code ID



@CID019

Modify China Post 25 Code ID



@CID020

Modify AIM 128 Code ID

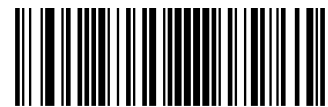

@SETUPE0

**** Exit Setup**



@SETUPE1
Enter Setup



@CID021
Modify ISBT 128 Code ID



@CID023
Modify ISSN Code ID



@CID024
Modify ISBN Code ID



@CID025
Modify Industrial 25 Code ID



@CID026
Modify Standard 25 Code ID



@CID027
Modify Plessey Code ID



@CID028
Modify Code 11 Code ID



@CID029
Modify MSI-Plessey Code ID



@SETUPE0
**** Exit Setup**



@SETUPE1

Enter Setup



@CID030

Modify GS1 Composite Code ID



@CID031

Modify GS1 Databar Code ID

2D symbologies:



@CID032

Modify PDF417 Code ID



@CID033

Modify QR Code ID



@CID034

Modify Aztec Code ID



@CID035

Modify Data Matrix Code ID

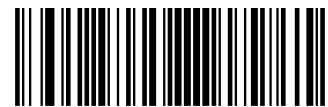

@SETUPE0

**** Exit Setup**



@SETUPE1
Enter Setup

Custom Suffix

Enable/Disable Custom Suffix

If custom suffix is enabled, you are allowed to append to the data a user-defined suffix that cannot exceed 10 characters. For example, if the custom suffix is “AB” and the barcode data is “123”, the Host will receive “123AB”.



@CSUENA0
** Disable Custom Suffix



@CSUENA1
Enable Custom Suffix

Set Custom Suffix

To set a custom suffix, scan the **Set Custom Suffix** barcode then the numeric barcodes corresponding to the hexadecimal value of a desired suffix then the **Save** barcode.

Note: A custom suffix cannot exceed 10 characters.



@CSUSET
Set Custom Suffix

E
sample

Set the custom suffix to “CODE” (HEX: 0x43/0x4F/0x44/0x45):

1. Scan the **Enter Setup** barcode.
2. Scan the **Set Custom Suffix** barcode.
3. Scan the numeric barcodes “4”, “3”, “4”, “F”, “4”, “4”, “4” and “5” from the “Digit Barcodes” section in Appendix.
4. Scan the **Save** barcode from the “Save/Cancel Barcodes” section in Appendix.
5. Scan the **Enable Custom Suffix** barcode.
6. Scan the **Exit Setup** barcode.



@SETUPE0
** Exit Setup



@SETUPE1
Enter Setup

Data Packing

Introduction

Data packing is designed for a specific group of users who want to have the data packed before transmission. Data packing influences data format, so it is advised to disable this feature when it is not required.

Data Packing Options

Disable Data Packing: Transmit decoded data in raw format (unpacked).

Enable Data Packing, Format 1: Transmit decoded data with the packet format 1 defined below.

Packet format 1: [STX + ATTR + LEN] + [AL_TYPE + DATA] + [LRC]

STX: 0x02

ATTR: 0x00

LEN: Barcode data length is expressed in 2 bytes ranging from 0x0000 (0) to 0xFFFF (65535).

AL_TYPE: 0x36

DATA: Raw barcode data.

LRC: Check digit.

LRC calculation algorithm: computation sequence: 0xFF+LEN+AL_TYPE+DATA; computation method is XOR, byte by byte.

Enable Data Packing, Format 2: Transmit decoded data with the packet format 2 defined below.

Packet format 2: [STX + ATTR + LEN] + [AL_TYPE] + [Symbology_ID + DATA] + [LRC]

STX: 0x02

ATTR: 0x00

LEN: Barcode data length is expressed in 2 bytes ranging from 0x0000 (0) to 0xFFFF (65535).

AL_TYPE: 0x3B

Symbology_ID: The ID number of symbology, 1 byte.

DATA: Raw barcode data.

LRC: Check digit.

LRC calculation algorithm: computation sequence: 0xFF+LEN+AL_TYPE+Symbology_ID+DATA; computation method is XOR, byte by byte.



@SETUPE0
** Exit Setup



@SETUPE1

Enter Setup



@PACKAG0

**** Disable Data Packing**



@PACKAG1

Enable Data Packing, Format 1

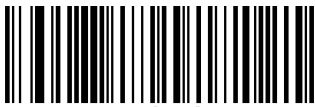

@PACKAG2

Enable Data Packing, Format 2



@SETUPE0

**** Exit Setup**



@SETUPE1
Enter Setup

Terminating Character Suffix

Enable/Disable Terminating Character Suffix

A terminating character such as carriage return (CR) or carriage return/line feed pair (CRLF) can only be used to mark the end of data, which means nothing can be added after it.



@TSUENA0

Disable Terminating Character Suffix



@TSUENA1

**** Enable Terminating Character Suffix**

Set Terminating Character Suffix

To set a terminating character suffix, scan the **Set Terminating Character Suffix** barcode then the numeric barcodes corresponding to the hexadecimal value of a desired terminating character then the **Save** barcode.

Note: A terminating character suffix cannot exceed 2 characters.



@TSUSET

Set Terminating Character Suffix



@TSUSET0D

Set Terminating Character to CR (0x0D)



@TSUSET0D0A

Set Terminating Character to CRLF (0x0D,0x0A)

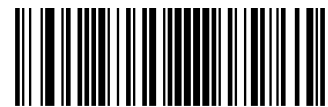

@SETUPE0

**** Exit Setup**



@SETUPE1
Enter Setup

E
sample

Set the terminating character suffix to 0x0A:

1. Scan the **Enter Setup** barcode.
2. Scan the **Set Terminating Character Suffix** barcode.
3. Scan the numeric barcodes “0” and “A” from the “Digit Barcodes” section in Appendix.
4. Scan the **Save** barcode from the “Save/Cancel Barcodes” section in Appendix.
5. Scan the **Enable Terminating Character Suffix** barcode.
6. Scan the **Exit Setup** barcode.



@SETUPE0
**** Exit Setup**



@SETUPE1
Enter Setup

Chapter 7 Batch Programming

Introduction

Batch programming enables users to integrate a batch of commands into a single batch barcode.

Listed below are batch programming rules:

1. Command format: Command + Parameter Value.
2. Each command is terminated by a semicolon (;). Note that there is no space between a command and its terminator semicolon.
3. Use the barcode generator software to generate a 2D batch barcode.

Example: Create a batch barcode for **Illumination On, Sense Mode, Decode Session Timeout = 2s**:

1. Input the commands:

@ILLSCN1;SCNMOD2;ORTSET2000;

2. Generate a batch barcode.

When setting up a scanner with the above configuration, scan the **Enable Batch Barcode** barcode and then the batch barcode generated.



@BATCHS
Enable Batch Barcode

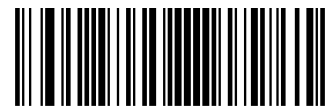

@SETUPE0
** Exit Setup



@SETUPE1
Enter Setup

Create a Batch Command

A batch command may contain a number of individual commands each of which is terminated by a semicolon (;).

For more information, refer to the “Use of Programming Command” section in Chapter 3.

Create a Batch Barcode

Batch barcodes can be produced in the format of PDF417, QR Code or Data Matrix.

Example: Create a batch barcode for **Illumination On, Sense Mode, Decode Session Timeout = 2s**:

1. Input the following commands:

```
@ILLSCN1;SCNMOD2;ORTSET2000;
```

2. Generate a PDF417 batch barcode.

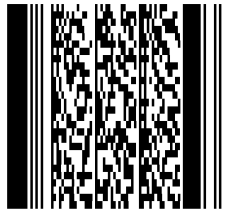

@SETUPE0
** Exit Setup



@SETUPE1
Enter Setup

Use Batch Barcode

To put a batch barcode into use, scan the following barcodes. (Use the example above.)

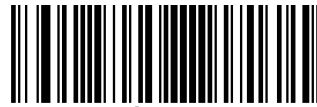

@SETUPE1
Enter Setup



@BATCHS
Enable Batch Barcode

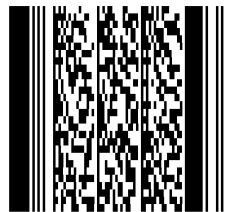
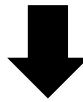

Batch Barcode



@SETUPE0
Exit Setup



@SETUPE0
** Exit Setup

Appendix

Digit Barcodes

0~9



@DIGIT0

0



@DIGIT2

2



@DIGIT4

4



@DIGIT1

1



@DIGIT3

3



@DIGIT5

5



@DIGIT6

6



@DIGIT7

7



@DIGIT8

8



@DIGIT9

9

A~F



@DIGITA

A



@DIGITB

B

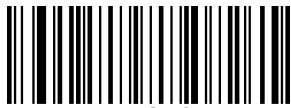

@DIGITC

C



@DIGITD

D



@DIGITE

E



@DIGITF

F

Save/Cancel Barcodes

After reading numeric barcode(s), you need to scan the **Save** barcode to save the data. If you scan the wrong digit(s), you can either scan the **Cancel** barcode and then start the configuration all over again, or scan the **Delete the Last Digit** barcode and then the correct digit, or scan the **Delete All Digits** barcode and then the digits you want.

For instance, after reading the **Maximum Length** barcode and numeric barcodes “1”, “2” and “3”, you scan:

- ✧ **Delete the Last Digit:** The last digit “3” will be removed.
- ✧ **Delete All Digits:** All digits “123” will be removed.
- ✧ **Cancel:** The maximum length configuration will be cancelled. And the scanner is still in the setup mode.



@DIGSAV

Save



@DIGCAN

Cancel



@DIGDEL

Delete the Last Digit



@DIGDAL

Delete All Digits

Factory Defaults Table

Parameter	Factory Default	Remark
System Settings		
Barcode Programming	Disabled (Exit Setup)	
Programming Barcode Data	Do not transmit	
Illumination	On	
Aiming	On	
Good Read LED	On	
Good Read LED Duration	Short (20ms)	
Power On Beep	On	
Good Read Beep	On	
Good Read Beep Volume	Loud	
Good Read Vibration	On	
Good Read Vibration Duration	300ms	100-2000ms
Scan Mode	Level Mode	
Decode Session Timeout	3,000ms.	1-3,600,000ms; 0: Infinite
Image Stabilization Timeout (Sense Mode)	200ms	1-3,000ms
Timeout between Decodes (Same Barcode)	Disabled	
	1,500ms	1-3,600,000ms
Reread Timeout Reset	Off	
Image Decoding Timeout	500ms	1-3,000ms
Sensitivity	Enhanced Sensitivity	
Trigger Commands	Disabled	
Scanning Preference	Normal Mode	
Read Barcode	On	
Decode Area	Whole Area Decoding	
Specify Decoding Area	40% top, 60% bottom, 40% left, 60% right	
Image Flipping	Do Not Flip	
Bad Read Message	Off	
	NG	1-7 characters
Default Interface	USB KBW	
USB Interface		
USB Country Keyboard	US keyboard	USB HID Keyboard
Beep on Unknown Character	Off	USB HID Keyboard
Emulate ALT+Keypad	Off	USB HID Keyboard
Code Page	Code Page 1252 (West European Latin)	USB HID Keyboard

Unicode Encoding	Off	USB HID Keyboard
Emulate Keypad with Leading Zero	On	USB HID Keyboard
Function Key Mapping	Disable	USB HID Keyboard
Inter-Keystroke Delay	No Delay	USB HID Keyboard
Caps Lock	Caps Lock Off, Non-Japanese Keyboard	USB HID Keyboard
Convert Case	No Case Conversion	USB HID Keyboard
Emulate Numeric Keypad 1	Off	USB HID Keyboard
Emulate Numeric Keypad 2	Off	USB HID Keyboard
Fast Mode	Off	USB HID Keyboard
Polling Rate	4ms	USB HID Keyboard
Symbologies		
Global Settings		
1D Twin Code	Single 1D Code Only	
Code 128		
Code 128	Enabled	
Maximum Length	48	
Minimum Length	1	
EAN-8		
EAN-8	Enabled	
Check Character	Transmit	
2-Digit Add-On Code	Disabled	
5-Digit Add-On Code	Disabled	
Convert EAN-8 to EAN-13	Disabled	
EAN-13		
EAN-13	Enabled	
Check Character	Transmit	
2-Digit Add-On Code	Disabled	
5-Digit Add-On Code	Disabled	
UPC-E		
UPC-E0	Enabled	
UPC-E1	Disabled	
Check Character	Transmit	
2-Digit Add-On Code	Disabled	
5-Digit Add-On Code	Disabled	
Transmit Preamble Character	System Character	
Convert UPC-E to UPC-A	Disabled	
UPC-A		
UPC-A	Enabled	

Check Character	Transmit	
2-Digit Add-On Code	Disabled	
5-Digit Add-On Code	Disabled	
Transmit Preamble Character	No Preamble	
Coupon		
UPC-A/EAN-13 with Extended Coupon Code	Off	
Coupon GS1 DataBar Output	Off	
Interleaved 2 of 5		
Interleaved 2 of 5	Disabled	
Maximum Length	80	
Minimum Length	6	No less than 4
Check Character Verification	Disabled	
ITF-14		
ITF-14	Disabled	
ITF-6		
ITF-6	Disabled	
Matrix 2 of 5		
Matrix 2 of 5	Disabled	
Maximum Length	80	
Minimum Length	4	No less than 4
Check Character Verification	Disabled	
Code 39		
Code 39	Enabled	
Maximum Length	48	
Minimum Length	1	
Check Character Verification	Disabled	
Start/Stop Character	Do not transmit	
Code 39 Full ASCII	Disabled	
Code 32 Pharmaceutical (PARAF)	Disabled	
Code 32 Prefix	Disabled	
Code 32 Start/Stop Character	Do not transmit	
Code 32 Check Character	Do not transmit	
Codabar		
Codabar	Disabled	
Maximum Length	60	
Minimum Length	2	
Check Character Verification	Disabled	

Start/Stop Character	Do not transmit ABCD/ABCD	
Code 93		
Code 93	Disabled	
Maximum Length	48	
Minimum Length	1	
Check Character Verification	Do Not Transmit Check Character After Verification	
China Post 25		
China Post 25	Disabled	
Maximum Length	48	
Minimum Length	1	
Check Character Verification	Disabled	
GS1-128 (UCC/EAN-128)		
GS1-128	Enabled	
Maximum Length	48	
Minimum Length	1	
GS1 Databar		
GS1 Databar	Disabled	
Application Identifier "01"	Transmit	
EAN-UCC Composite		
GS1 Composite	Disabled	
UPC/EAN Composite	Disabled	
Code 11		
Code 11	Disabled	
Maximum Length	48	
Minimum Length	4	No less than 4
Check Character Verification	One Check Character, MOD11	
Check Character	Transmit	
ISBN		
ISBN	Enabled	
Set ISBN Format	ISBN-10	
ISSN		
ISSN	Enabled	
Industrial 25		
Industrial 25	Disabled	
Maximum Length	48	
Minimum Length	6	No less than 4
Check Character Verification	Disabled	

Standard 25		
Standard 25	Disabled	
Maximum Length	48	
Minimum Length	6	No less than 4
Check Character Verification	Disabled	
Plessey		
Plessey	Disabled	
Maximum Length	48	
Minimum Length	4	No less than 4
Check Character Verification	Disabled	
MSI-Plessey		
MSI-Plessey	Disabled	
Maximum Length	48	
Minimum Length	4	No less than 4
Check Character Verification	One Check Character, MOD10	
Check Character	Transmit	
AIM 128		
AIM 128	Enabled	
Maximum Length	48	
Minimum Length	1	
ISBT 128		
ISBT 128	Disabled	
PDF417		
PDF417	Enabled	
Maximum Length	2710	
Minimum Length	1	
PDF417 Twin Code	Single PDF417 Only	
PDF417 Inverse	Decode Both	
Character Encoding	Default Character Encoding	
PDF417 ECI Output	Enabled	
QR Code		
QR Code	Enabled	
Maximum Length	7089	
Minimum Length	1	
QR Twin Code	Single QR Only	
QR Inverse	Decode Both	
Character Encoding	Default Character Encoding	
QR ECI Output	Enabled	

Aztec		
Aztec Code	Disabled	
Maximum Length	3832	
Minimum Length	1	
Read Multi-barcodes on an Image	Mode 1	
Character Encoding	Default Character Encoding	
Aztec ECI Output	Enabled	
Data Matrix		
Data Matrix	Enabled	
Maximum Length	3116	
Minimum Length	1	
Data Matrix Twin Code	Single Data Matrix Only	
Rectangular Barcode	Enabled	
Data Matrix Inverse	Decode Regular Data Matrix Barcodes Only	
Character Encoding	Default Character Encoding	
Data Matrix ECI Output	Enabled	
Data Formatter		
Data Formatter	Disabled	
Non-Match Error Beep	On	
Data Format Selection	Format_0	
Prefix & Suffix		
All Prefixes/Suffixes	Disabled	
Prefix Sequence	Code ID+ Custom +AIM ID	
Custom Prefix	Disabled	
AIM ID Prefix	Disabled	
Code ID Prefix	Disabled	
Custom Suffix	Disabled	
Data Packing	Disable Data Packing	
Terminating Character Suffix	Enabled	

AIM ID Table

Symbology	AIM ID	Possible AIM ID Modifiers (m)
Code128]C0	
GS1-128 (UCC/EAN-128)]C1	
EAN-8]E4	
EAN-8 with Addon]E3	
EAN-13]E0	
EAN-13 with Addon]E3	
UPC-E]E0	
UPC-E with Addon]E3	
UPC-A]E0	
UPC-A with Addon]E3	
Interleaved 2 of 5]Im	0, 1, 3
ITF-14]Im	1, 3
ITF-6]Im	1, 3
Matrix 2 of 5]X0	
Code 39]Am	0, 1, 3, 4, 5, 7
Codabar]Fm	0, 2, 4
Code 93]G0	
China Post 25]X0	
AIM 128]C2	
ISBT 128]C4	
ISSN]X0	
ISBN]X0	
Industrial 25]S0	
Standard 25]R0	
Plessey]P0	
Code 11]Hm	0, 1, 3
MSI Plessey]Mm	0, 1
GS1 Composite]em	0-3
GS1 Databar (RSS)]e0	

Symbology	AIM ID	Possible AIM ID Modifiers (m)
PDF417]Lm	0-2
QR Code]Qm	0-6
Aztec]zm	0-9, A-C
Data Matrix]dm	0-6

Note: “m” represents the AIM modifier character. Refer to ISO/IEC 15424:2008 Information technology – Automatic identification and data capture techniques – Data Carrier Identifiers (including Symbology Identifiers) for AIM modifier character details.

Code ID Table

Symbology	Code ID
Code128	j
GS1-128 (UCC/EAN-128)	j
EAN-8	d
EAN-13	d
UPC-E	c
UPC-A	c
Interleaved 2 of 5	e
ITF-14	e
ITF-6	e
Matrix 2 of 5	v
Code 39	b
Codabar	a
Code 93	i
China Post 25	X
AIM 128	X
ISBT 128	X
ISSN	g
ISBN	B
Industrial 25	l
Standard 25	f
Plessey	n
Code 11	H
MSI Plessey	m
GS1 Composite	y
GS1 Databar (RSS)	R
PDF417	r
QR Code	s
Aztec	z
Data Matrix	u

Symbology ID Number

Symbology	ID Number
Code 128	002
GS1-128 (UCC/EAN-128)	003
EAN-8	004
EAN-13	005
UPC-E	006
UPC-A	007
Interleaved 2 of 5	008
ITF-14	009
ITF-6	010
Matrix 2 of 5	011
Code 39	013
Codabar	015
Code 93	017
China Post 25	019
AIM 128	020
ISBT 128	021
ISSN	023
ISBN	024
Industrial25	025
Standard25	026
Plessey	027
Code11	028
MSI-Plessey	029
GS1 Composite	030
GS1 Databar (RSS)	031
PDF417	032
QR Code	033
Aztec	034
Data Matrix	035

ASCII Table

Hex	Dec	Char
00	0	NUL (Null char.)
01	1	SOH (Start of Header)
02	2	STX (Start of Text)
03	3	ETX (End of Text)
04	4	EOT (End of Transmission)
05	5	ENQ (Enquiry)
06	6	ACK (Acknowledgment)
07	7	BEL (Bell)
08	8	BS (Backspace)
09	9	HT (Horizontal Tab)
0a	10	LF (Line Feed)
0b	11	VT (Vertical Tab)
0c	12	FF (Form Feed)
0d	13	CR (Carriage Return)
0e	14	SO (Shift Out)
0f	15	SI (Shift In)
10	16	DLE (Data Link Escape)
11	17	DC1 (XON) (Device Control 1)
12	18	DC2 (Device Control 2)
13	19	DC3 (XOFF) (Device Control 3)
14	20	DC4 (Device Control 4)
15	21	NAK (Negative Acknowledgment)
16	22	SYN (Synchronous Idle)
17	23	ETB (End of Trans. Block)
18	24	CAN (Cancel)
19	25	EM (End of Medium)
1a	26	SUB (Substitute)
1b	27	ESC (Escape)
1c	28	FS (File Separator)
1d	29	GS (Group Separator)

Hex	Dec	Char
1e	30	RS (Request to Send)
1f	31	US (Unit Separator)
20	32	SP (Space)
21	33	! (Exclamation Mark)
22	34	" (Double Quote)
23	35	# (Number Sign)
24	36	\$ (Dollar Sign)
25	37	% (Percent)
26	38	& (Ampersand)
27	39	` (Single Quote)
28	40	((Left/ Opening Parenthesis)
29	41) (Right/ Closing Parenthesis)
2a	42	* (Asterisk)
2b	43	+ (Plus)
2c	44	, (Comma)
2d	45	- (Minus/ Dash)
2e	46	. (Dot)
2f	47	/ (Forward Slash)
30	48	0
31	49	1
32	50	2
33	51	3
34	52	4
35	53	5
36	54	6
37	55	7
38	56	8
39	57	9
3a	58	: (Colon)
3b	59	; (Semi-colon)
3c	60	< (Less Than)
3d	61	= (Equal Sign)

Hex	Dec	Char
3e	62	> (Greater Than)
3f	63	? (Question Mark)
40	64	@ (AT Symbol)
41	65	A
42	66	B
43	67	C
44	68	D
45	69	E
46	70	F
47	71	G
48	72	H
49	73	I
4a	74	J
4b	75	K
4c	76	L
4d	77	M
4e	78	N
4f	79	O
50	80	P
51	81	Q
52	82	R
53	83	S
54	84	T
55	85	U
56	86	V
57	87	W
58	88	X
59	89	Y
5a	90	Z
5b	91	[(Left/ Opening Bracket)
5c	92	\ (Back Slash)
5d	93] (Right/ Closing Bracket)

Hex	Dec	Char
5e	94	^ (Caret/ Circumflex)
5f	95	_ (Underscore)
60	96	' (Grave Accent)
61	97	a
62	98	b
63	99	c
64	100	d
65	101	e
66	102	f
67	103	g
68	104	h
69	105	i
6a	106	j
6b	107	k
6c	108	l
6d	109	m
6e	110	n
6f	111	o
70	112	p
71	113	q
72	114	r
73	115	s
74	116	t
75	117	u
76	118	v
77	119	w
78	120	x
79	121	y
7a	122	z
7b	123	{ (Left/ Opening Brace)
7c	124	(Vertical Bar)
7d	125	} (Right/ Closing Brace)
7e	126	~ (Tilde)
7f	127	DEL (Delete)

Unicode Key Maps

6E	70	71	72	73	74	75	76	77	78	79	7A	7B	7C	7D	7E	•	•	•		
01	02	03	04	05	06	07	08	09	0A	0B	0C	0D	0F	4B	50	55	5A	5F	64	69
10	11	12	13	14	15	16	17	18	19	1A	1B	1C	1D	4C	51	56	5B	60	65	6A
1E	1F	20	21	22	23	24	25	26	27	28	29	2B				5C	61	66		
2C	2E	2F	30	31	32	33	34	35	36	37	39			53			5D	62	67	6C
3A	3B	3C	3D					3E	3F	38	40	4F	54	59	63	68				

104 Key U.S. Style Keyboard

6E	70	71	72	73	74	75	76	77	78	79	7A	7B	7C	7D	7E	•	•	•		
01	02	03	04	05	06	07	08	09	0A	0B	0C	0D	0F	4B	50	55	5A	5F	64	69
10	11	12	13	14	15	16	17	18	19	1A	1B	1C	2B	4C	51	56	5B	60	65	6A
1E	1F	20	21	22	23	24	25	26	27	28	29	1D				5C	61	66		
2C	2D	2E	2F	30	31	32	33	34	35	36	37	39		53			5D	62	67	6C
3A	3B	3C	3D					3E	3F	38	40	4F	54	59	63	68				

105 Key European Style Keyboard

